

RX 450

FINESTRE A BATTENTE

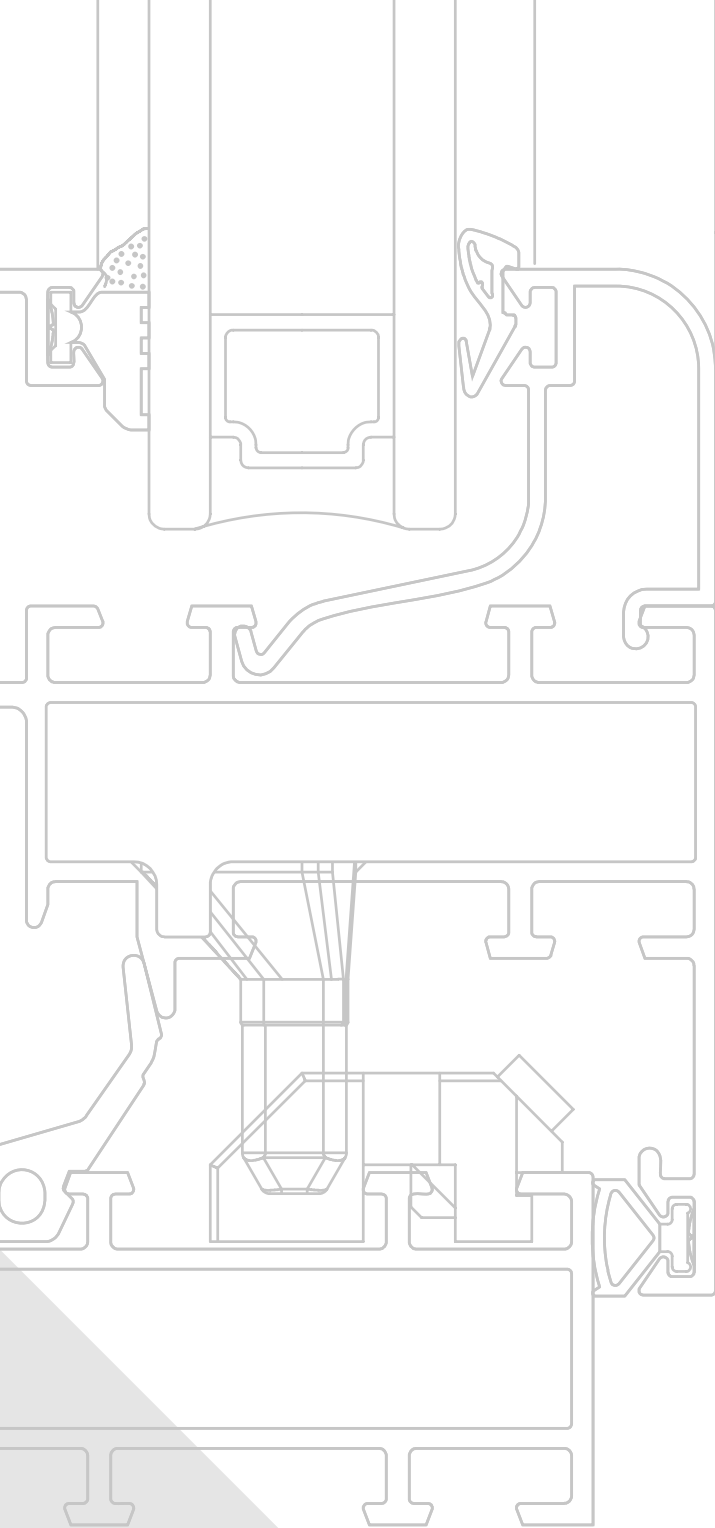



RX 450

FINESTRE A BATTENTE



**Informazioni generali****Gruppo A**

Indice generale
Caratteristiche alluminio
Descrizione tecnica sistema
Descrizione tecnica capitolato
Collaudi prestazionali

Profilati**Gruppo B**

Elenco profilati
Profilati scala 1.1

Accessori e Guarnizioni**Gruppo C**

Elenco accessori
Elenco guarnizioni

Sezioni**Gruppo D**

Sezioni principali
in scala 1:1
corredate dei relativi accessori

Tipologie**Gruppo E**

Principali tipologie di finestre

Collegamento muratura**Gruppo F**

Sezione particolareggiata
attacco alla muratura

Lavorazioni / Montaggi**Gruppo G**

Schemi lavorazioni
Frese
Attrezzature

**PESO PROFILATI**

Il peso indicato è quello teorico e potrà variare in funzione delle tolleranze di spessore e dimensionali dei profilati (NORMA UNI EN 12020-2)

LEGA DI ESTRUSIONE

I profilati sono estrusi in lega EN-AW-6060 (UNI EN 573/3)

DIMENSIONI DEI PROFILATI

Le dimensioni indicate sono quelle teoriche, potranno quindi variare in funzione delle tolleranze dimensionali di estrusione (norma UNI EN 12020-2). Questa variabilità che interessa tutti i profilati, può influire, anche se minimamente, sulle dimensioni di taglio e quindi finali del serramento. Anche la verniciatura, aumentando gli spessori, contribuisce a far variare la dimensione dei profilati e, particolarmente, riduce lo spazio nelle sedi di inserimento delle guarnizioni e degli accessori.

DIMENSIONI DI TAGLIO E LAVORAZIONI

Le dimensioni teoriche di taglio e le quote delle lavorazioni indicate nel presente catalogo sono esatte, ovvero matematicamente corrette, in certi casi dovranno, nella pratica, essere adattate in base alla precisione ed al tipo di impostazione delle misure delle macchine utilizzate. È pertanto consigliabile nei primi lavori o nel caso di importanti quantità di serramenti effettuare delle campionature di prova.

PROTEZIONE SUPERFICIALE

Al fine di limitare i processi di corrosione filiforme è importante applicare le seguenti regole:

- utilizzare accessori di assemblaggio in alluminio utilizzare viti in acciaio inox ,
- proteggere le parti tagliate e lavorate con prodotti idonei
- evitare ristagni di condense all'interno dei profilati.

Per la realizzazione di serramenti è necessario attenersi alla tecnologia costruttiva e utilizzare le guarnizioni e gli accessori originali riportati sul catalogo tecnico e al rispetto delle norme, prescrizioni e raccomandazioni vigenti. L'osservanza di quanto sopra determina la garanzia .Su queste basi sono stati realizzati campioni che, collaudati in laboratorio hanno ottenuto i risultati indicati nelle certificazioni. Per il buon funzionamento e la durata degli infissi realizzati con profilati ed accessori del sistema , è necessario effettuare alcune semplici operazioni: una buona pulizia, eliminando residui di calce, cemento e/o altro. È consigliabile peraltro proteggere il manufatto sino al momento della messa in esercizio, lubrificare con olio o grasso neutri le parti in movimento e gli organi di chiusura, controllare il corretto serraggio delle viti e dei grani, controllare gli assetti, registrandoli laddove sono previste regolazioni. Si raccomanda di effettuare queste operazioni almeno con cadenza semestrale. In caso di funzionamento anomalo di qualche componente, evitare assolutamente interventi atti a modificarne le caratteristiche e la sostituzione con ricambi non originali. Ci sembra utile ricordare che interventi di regolazione e/o sostituzione, con particolare riferimento ai meccanismi per oscillo-battente, andranno eseguiti da personale specializzato. Si raccomanda inoltre, in occasione delle operazioni di pulizia, di non utilizzare detergenti che possano deteriorare i trattamenti superficiali, escludendo tassativamente acidi, solventi, materiali abrasivi, spazzole metalliche o comunque in grado di scalfire le superfici, pagliette metalliche e altro.

DIMENSIONI E TIPOLOGIA DEI SERRAMENTI

La valutazione delle dimensioni dei serramenti, richiede la considerazione di vari fattori quali: il momento d'inerzia dei profilati ,le dimensioni e il peso dei tamponamenti (vetri-pannelli),la larghezza e l'altezza delle parti apribili caratteristiche e portate degli accessori,le condizioni e le quantità degli ancoraggi alle opere morte,l'esposizione, ecc...Fattori che sono valutabili e applicabili, grazie alla buona conoscenza dello stato dell'arte, alle informazioni riportate dai cataloghi, manuali tecnici e dalle normative vigenti. Consigliamo, al fine di evitare inutili contestazioni, di consultare il nostro servizio tecnico sistemi, prima di realizzare serramenti che, per dimensione, forma, esposizione e/o altro possono essere ritenuti atipici. Le soluzioni e le combinazioni proposte in questo catalogo, non hanno carattere limitativo, ma presentano solo le situazioni e combinazioni più comunemente riscontrabili nella realtà. Soluzioni e combinazioni diverse, così come l'adozione di componentistica particolare, ad esempio meccanismi per la realizzazione di ante scorrevoli parallele, ante scorrevoli a libro o altro, sono possibili. A questo proposito il nostro servizio tecnico prodotti per l'edilizia può valutare e proporre le soluzioni più idonee.



DESCRIZIONE TECNICA PER CAPITOLATO

I profilati per serramenti saranno in lega di alluminio ENAW 6060 (EN 573-3 e EN 755-2) con stato fisico di fornitura UNI EN 515.

INFISSI

Le finestre e le porte finestre dovranno avere un profilato di telaio fisso con profondità minima 45 o 53 mm. ed un profilato di anta mobile con profondità minima 45 o 53 mm. I profilati di telaio fisso dovranno prevedere, dove necessario, alette incorporate di battuta interna sulla muratura da 22 mm . I profilati di ante mobili dovranno avere un'aletta esterna di battuta per vetro con altezza di 22 mm ed una aletta di battuta interna sul telaio fisso con sormonto di 8 mm.

DRENAGGI E VENTILAZIONE

I profilati esterni delle ante mobili dovranno prevedere una gola ribassata per la raccolta delle acque di infiltrazione e di condensa onde poter permettere il libero deflusso delle stesse attraverso apposite asole di scarico. Le barrette in poliammide dovranno avere una conformazione geometrica atta ad evitare eventuale ristagno di acque di infiltrazione e di condensa ed essere perfettamente complanari con le pareti trasversali dei profilati di alluminio.

ACCESSORI DI ASSEMBLAGGIO

Le giunzioni tra profilati orizzontali e verticali dovranno essere perfettamente solidali e ben allineate tra di loro, sia nella parte esterna che interna dei profilati ed unite mediante apposite squadrette a bottone o, in alternativa, in alluminio estruso o pressofuso, con metodo a spino-cianfrinatura od a cianfrinatura totale. Le sezioni dei profilati orizzontali e verticali dovranno essere opportunamente sigillate prima di essere unite con le squadrette. I fermavetri saranno accoppiati a scatto e posizionati nei canali dei profilati in alluminio .

GUARNIZIONI

Tutte le guarnizioni: cingivetro, di tenuta, di battuta... dovranno essere in elastomero (EPDM). In particolare la guarnizione di tenuta centrale (giunto aperto) dovrà assicurare la continuità perimetrale mediante l'impiego di angoli vulcanizzati preformati incollati alla stessa o in alternativa mediante telai vulcanizzati.

PRESTAZIONI

I serramenti dovranno avere prestazioni di permeabilità all'aria, tenuta all'acqua e resistenza ai carichi del vento conformemente alle norme :
(UNI-EN 12207 - 12208 - 12210 e UNI-EN 1026 - 1027 - 12211)

Permeabilità all'aria: classe _____

Tenuta all'acqua: classe _____

Resistenza al vento: classe _____

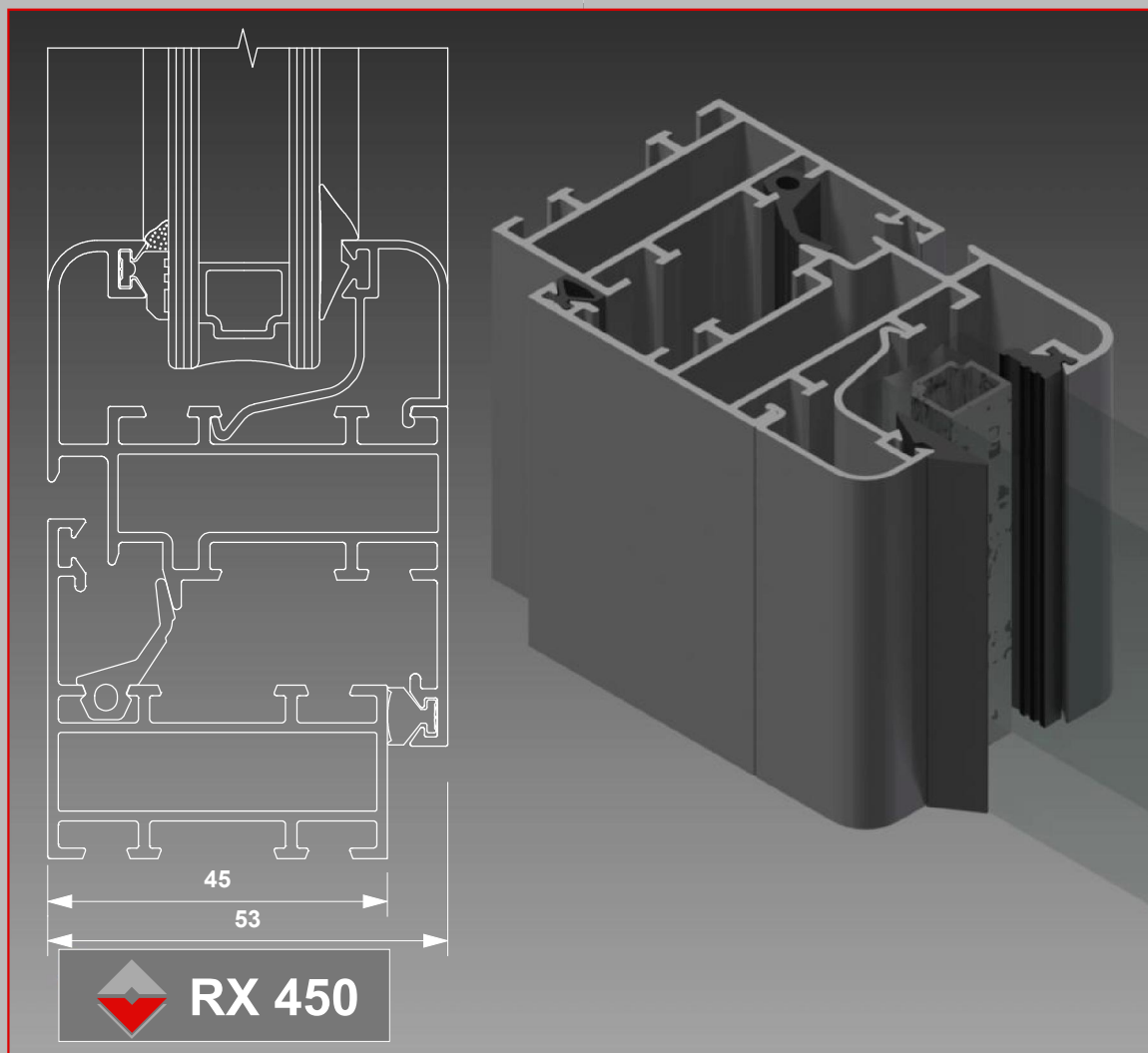
SCHEDA TECNICA

Profilati estrusi lega:

ENAW 6060 (EN 573 - 3)

Stato di fornitura:

T5 (EN 752 - 2)

Tolleranze dimensioni e spessori:

EN 755 - 9

Tipo di tenuta aria/acqua:

Finestre: guarnizione centrale (giunto aperto).

Porte: doppia battuta .

Inserimento del vetro :

con fermavetro a scatto sia rettangolare che arrotondato.

Altezza utile alloggiamento vetro:

mm. 22

Possibilità di inserimento volumi di vetro o pannelli con spessori variabili tra mm. 4 e 40.

Dimensioni principali
Telaio fisso :

mm. 45 o 53 (complanare)

Telaio mobile:

mm. 45 o 53 (complanare)

Controtelaio :

mm. 40

Fuga perimetrale interna ed esterna :

mm. 5

Alloggiamento accessori:

a Camera Unificata spazio 14 mm.

Giunzione angolare:

con squadrette a bottone, spinare o cianfrinare

Impiego:

Profilati per finestre che consentono la costruzione di infissi ad una, due o più ante a battente, nella versione a giunto aperto o con doppia guarnizione di battuta complanari all'esterno e a sormonto all'interno. Sono possibili anche specchiature fisse, wasistas, anta-ribalta.

Profilati per porte: consentono la costruzione di porte ad una o due ante, apribili sia all'interno che all'esterno, con sopraluci fissi od apribili e vetrine.

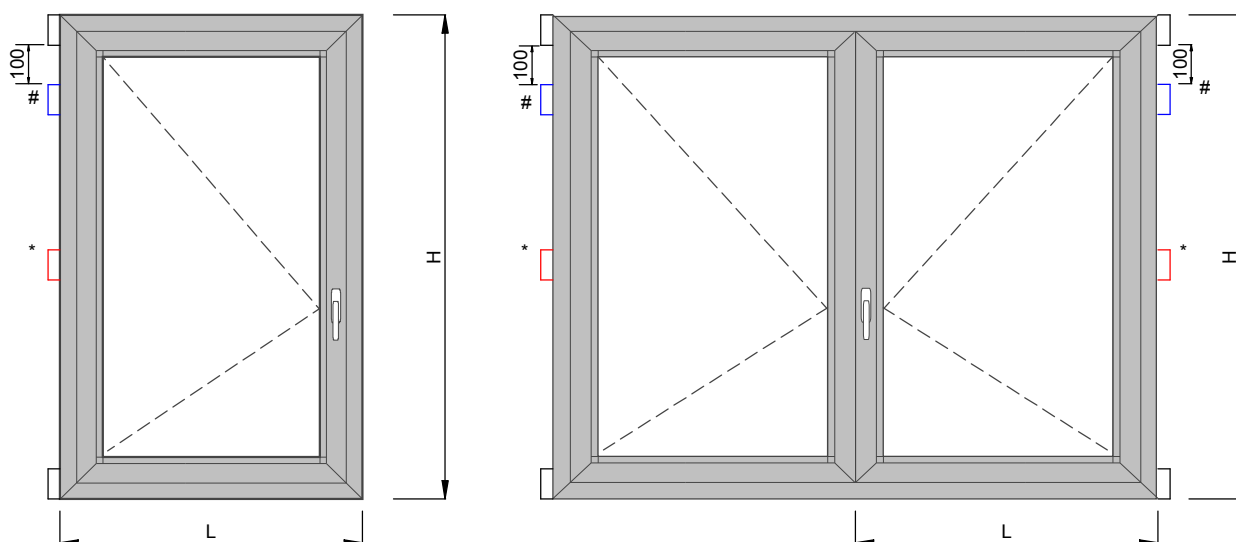
Battente Una e Due Ante Cerniere
ARX.02.01 e ARX.02.03

Dimensioni Anta Minima (LxH): 430 x 500

Norma per Stringa di Prodotto EN 1935:2004

Tipo	Categoria D'uso (1)	Durabilità (2)	Massa (3)	Resistenza Fuoco (4)	Sicurezza D'uso (5)	Resistenza Corrosione (6)	Resistenza Effrazione (7)	Grado Cerniera (8)
ARX.02.01	1	4	2 (80Kg)	0	1	4	0	6
ARX.02.03	1	4	3 (120Kg)	0	1	4	0	9

Dimensione Massime Anta (LxH)

Un Anta 2 Cerniere	Un Anta 3 Cerniere *	Un Anta 4 Cerniere *e#
1000x1600	1200x1800	1300x2100
Due Ante 2 Cerniere	Due Ante 3 Cerniere *	Due Ante 4 Cerniere *e#
1000x1500	1000x1700	1000x2100

Legenda Stringa di Prodotto

Categoria D'uso (1)	Durabilità (2) Cicli test	Massa (3) x cerniera	Resistenza Fuoco (4)	Sicurezza D'uso (5)	Resistenza Corrosione (6)	Resistenza Effrazione (7)	Grado Cerniera (8)
1:leggero	3:10.000	2: 40 Kg	0: non idoneo	1: soddisfatto	4: 240h in nebbia salina in accordo alla UNI EN 1670:2008	1	il suo valore è dato dalla combinazione di Massa e cicli
2:Medio	4.25.000	3: 60 Kg					
3:Pesante	7:200.000	4: 80 Kg	1: idoneo				
4:Intenso		5: 100 Kg					

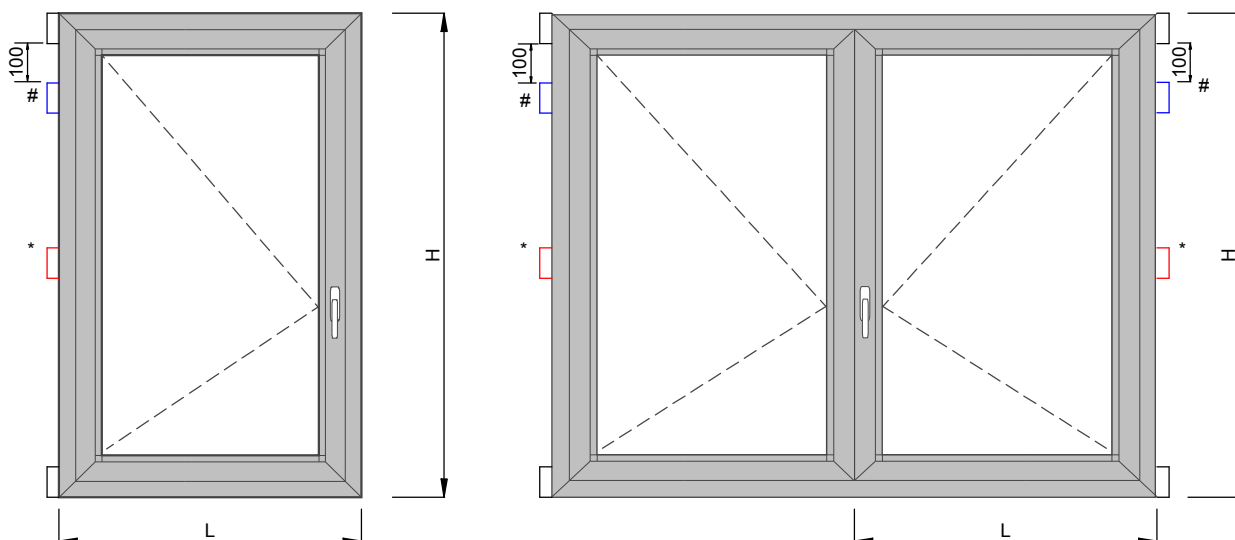
Battente Una e Due Ante Cerniere a pettine
ARX.08.09

Dimensione Anta Minima (LxH): 430 x 500

Norma per Stringa di Prodotto EN 1935:2004

Tipo	Categoria D'uso (1)	Durabilità (2)	Massa (3)	Resistenza Fuoco (4)	Sicurezza D'uso (5)	Resistenza Corrosione (6)	Resistenza Effrazione (7)	Grado Cerniera (8)
ARX.08.09	2	7	2 (80Kg)	0	1	4	0	7

Dimensione Massime Anta (LxH)

Un Anta 2 Cerniere	Un Anta 3 Cerniere *	Un Anta 4 Cerniere *e#
1000x1600	1200x1800	1300x2100
Due Ante 2 Cerniere	Due Ante 3 Cerniere *	Due Ante 4 Cerniere *e#
1000x1500	1000x1700	1000x2100

Legenda Stringa di Prodotto

Categoria D'uso (1)	Durabilità (2) Cicli test	Massa (3) x cerniera	Resistenza Fuoco (4)	Sicurezza D'uso (5)	Resistenza Corrosione (6)	Resistenza Effrazione (7)	Grado Cerniera (8)
1:leggero	3:10.000	2: 40 Kg	0: non idoneo	1: soddisfatto	4: 240h in nebbia salina in accordo alla UNI EN 1670:2008	1	il suo valore è dato dalla combinazione di Massa e cicli
2:Medio	4.25.000	3: 60 Kg					
3:Pesante	7:200.000	4: 80 Kg	1: idoneo				
4:Intenso		5: 100 Kg					

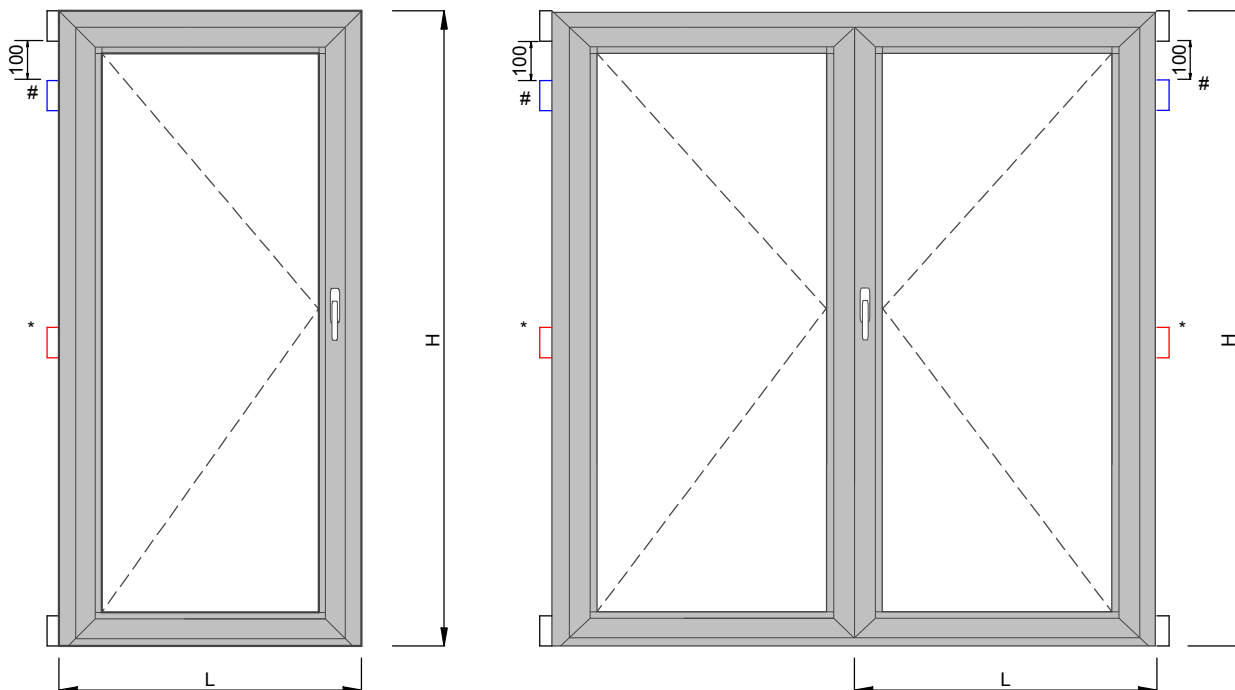
Cerniere per Profili Porte Applicazione Esterna
ARX.02.12 (2 ali) e ARX.02.13 (3 ali)

Norma per Stringa di Prodotto EN 1935:2004

Tipo	Categoria D'uso (1)	Durabilità (2)	Massa (3)	Resistenza Fuoco (4)	Sicurezza D'uso (5)	Resistenza Corrosione (6)	Resistenza Effrazione (7)	Grado Cerniera (8)
ARX.02.12	3	7	4 (160Kg)	0	1	4	0	11
ARX.02.13	3	7	5 (200Kg)	0	1	4	0	12

Dimensione Massime Anta (LxH)

Un Anta 2 Cerniere	Un Anta 3 Cerniere *	Un Anta 4 Cerniere *e#
1000x2200	1200x2200	1300x2200
Due Ante 2 Cerniere	Due Ante 3 Cerniere *	Due Ante 4 Cerniere *e#
800x2200	1000x2200	-

Legenda Stringa di Prodotto

Categoria D'uso (1)	Durabilità (2) Cicli test	Massa (3) x cerniera	Resistenza Fuoco (4)	Sicurezza D'uso (5)	Resistenza Corrosione (6)	Resistenza Effrazione (7)	Grado Cerniera (8)
1:leggero	3:10.000	2: 40 Kg	0: non idoneo	1: soddisfatto	4: 240h in nebbia salina in accordo alla UNI EN 1670:2008	1	il suo valore è dato dalla combinazione di Massa e cicli
2:Medio	4.25.000	3: 60 Kg					
3:Pesante	7:200.000	4: 80 Kg	1: idoneo				
4:Intenso		5: 100 Kg					

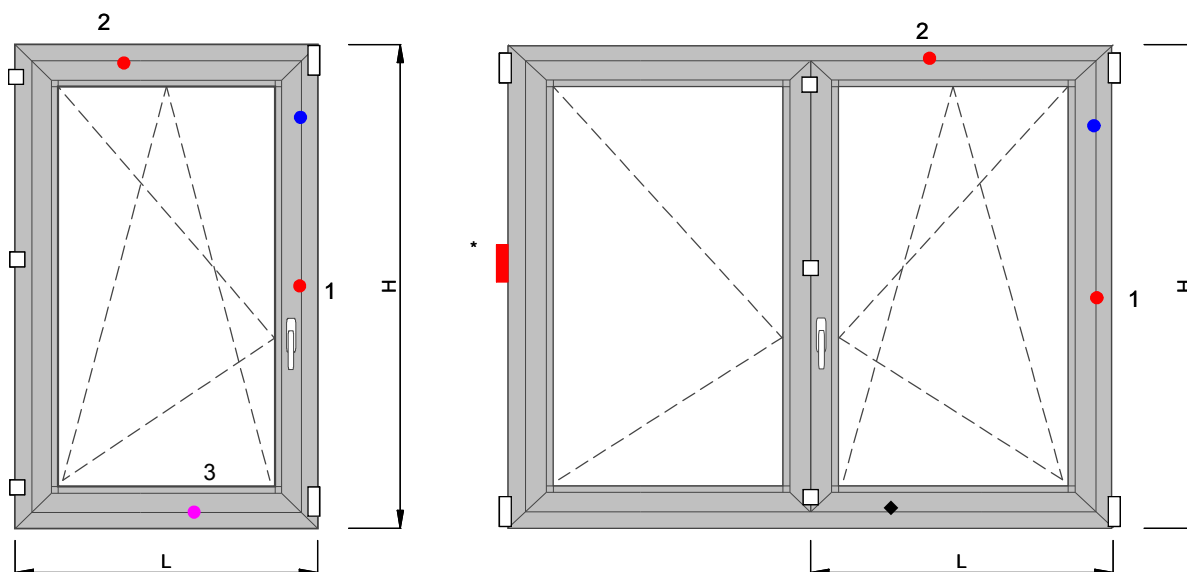
Aperture Oscillo battenti (80 Kg.) Una e Due Ante
ARX.08.01 Fulcro Verticale, ARX.08.10 Fulcro Orizzontale

- Punti di chiusura su Kit base Fulcro Verticale **ARX.08.01**
- ◆ + □ Punti di chiusura su Kit base Fulcro Orizzontale **ARX.08.10**
- Punti di chiusura supplementari Lato cerniera **ARX.08.06**
- Punti di chiusura supplementari **ARX.08.16**
- Punti di chiusura supplementari **ARX.08.17**

Norma per Stringa di Prodotto UNI EN 13126-8:2006

Tipo	Categoria D'uso (1)	Durabilità (2)	Massa (3)	Resistenza Fuoco (4)	Sicurezza D'uso (5)	Resistenza Corrosione (6)	Resistenza Effrazione (7)	Applicazione (8)	Dimensione di prova (9)
ARX.08.01	-	4	080 (80Kg)	0	1	4	-	8	1300x1200
ARX.08.10	-	4	080 (80Kg)	0	1	4	-	8	1300x1200

Braccio corto ARX.08.02

	Anta Singola LxH	Anta Doppia LxH	Punti di chiusura
Dimensioni Min	370x500	370x500	ARX.08.01
Dimensioni Max	600x1000	600x1000	ARX.08.01

Braccio Medio ARX.08.03

	Anta Singola LxH	Anta Doppia LxH	Punti di chiusura
Dimensioni Min	430x500	430x500	ARX.08.01
Dimensioni Max	600x1200	600x1200	ARX.08.01 + ARX.08.06
Dimensioni Max	600x2200	600x2200	ARX.08.01 + ARX.08.06 + Punto 1

Braccio Lungo ARX.08.04

	Anta Singola LxH	Anta Doppia LxH	Punti di chiusura
Dimensioni Min	600x600		ARX.08.01
Dimensioni Max	600x1200	600x1200	ARX.08.01 + ARX.08.06
Dimensioni Max	600x2200	600x2200	ARX.08.01 + ARX.08.06 + Punto 1
Dimensioni Max	1000x1200	1000x1200	ARX.08.10 + ARX.08.06 + Punto 1 e 2
Dimensioni Max	1000x2200	1000x2200	ARX.08.10 + ARX.08.06 + Punto 1, 2 e 3
Dimensioni Max	1300x1200	-	ARX.08.10 + ARX.08.06 + Punto 1, 2 e 3
Dimensioni Max	1300x2200	-	

Legenda Stringa di Prodotto

Categoria D'uso (1)	Durabilità (2) Cicli	Massa (3)	Resistenza Fuoco (4)	Sicurezza D'uso (5)	Resistenza Corrosione (6)	Resistenza Effrazione (7)	Applicazione (8)	Dimensione di prova (9)
-	4:15.000 a/r+5.000 battente	Portata Certificazione	0: non idoneo	1: Soddisfatto	4: 240h UNI EN 1670:2008	-	8:Privato	Dimensione Campione di prova



Cerniere Anta Affiancata

ARX.08.09		Portata 80 Kg.
Kit cerniera a pettine		100%= 80 Kg

H	2200	100%	100%	100%	100%	100%	100%	100%	100%
	2100	100%	100%	100%	100%	100%	100%	100%	100%
	2000	100%	100%	100%	100%	100%	100%	100%	94%
	1900	100%	100%	100%	100%	100%	100%	98%	86%
	1800	100%	100%	100%	100%	100%	100%	90%	78%
	1700	100%	100%	100%	100%	100%	95%	82%	71%
	1600	100%	100%	100%	100%	100%	85%	73%	63%
	1500	100%	100%	100%	100%	100%	76%	65%	55%
	1400	100%	100%	100%	96%	80%	67%	57%	N.D.
	1300	100%	100%	100%	84%	70%	58%	N.D.	N.D.
	1200	100%	100%	90%	73%	60%	N.D.	N.D.	N.D.
	1100	100%	97%	78%	62%	50%	N.D.	N.D.	N.D.
	1000	100%	83%	65%	51%	N.D.	N.D.	N.D.	N.D.
	600	700	800	900	1000	1100	1200	1300	
	L								

Zona Bianco

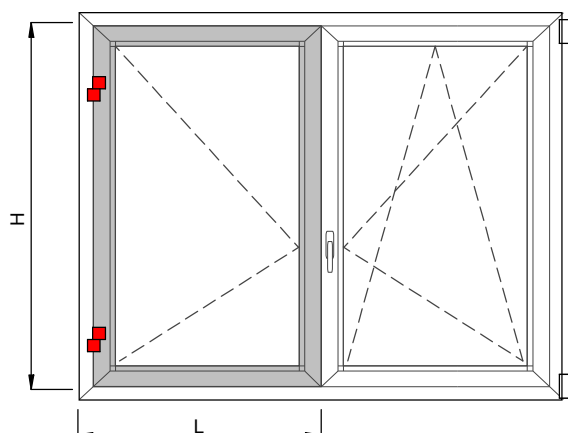

Zona Celeste

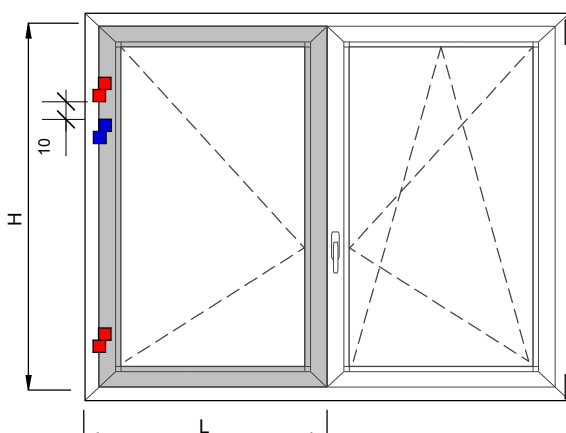

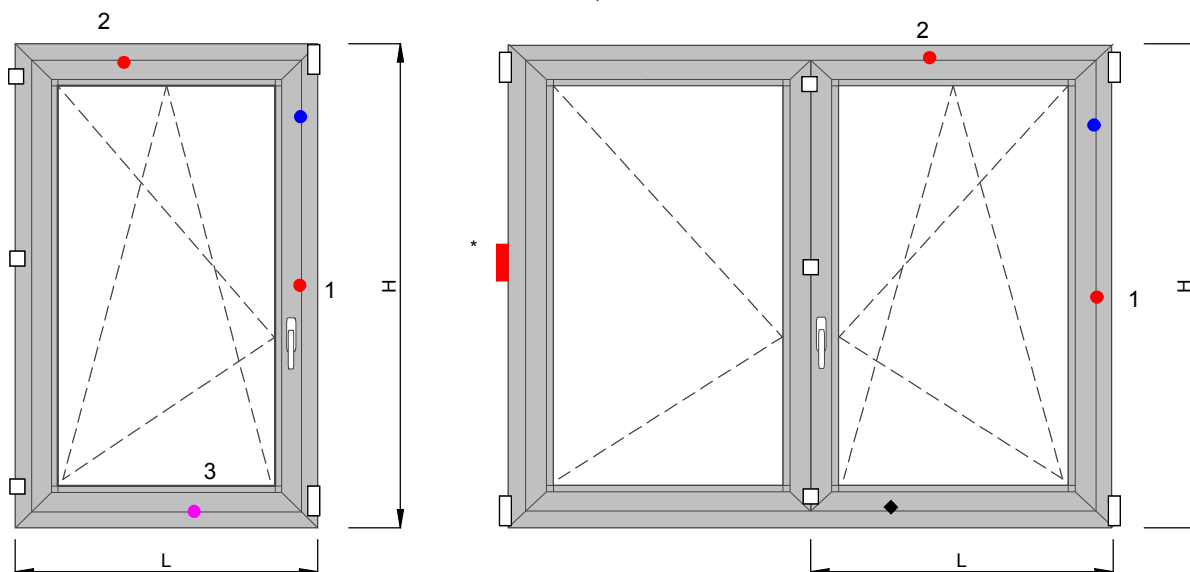
Aperture Oscillo battenti (120 Kg.) Una e Due Ante
ARX.08.20 Fulcro Verticale, **ARX.08.21** Fulcro Orizzontale

- Punti di chiusura su Kit base Fulcro Verticale **ARX.08.20**
- ◆ + □ Punti di chiusura su Kit base Fulcro Orizzontale **ARX.08.21**
- Punti di chiusura supplementari Lato cerniera **ARX.08.06**
- Punti di chiusura supplementari **ARX.08.16**
- Punti di chiusura supplementari **ARX.08.17**

Norma per Stringa di Prodotto UNI EN 13126-8:2006

Tipo	Categoria D'uso (1)	Durabilità (2)	Massa (3)	Resistenza Fuoco (4)	Sicurezza D'uso (5)	Resistenza Corrosione (6)	Resistenza Effrazione (7)	Applicazione (8)	Dimensione di prova (9)
ARX.08.20	-	4	120 (120Kg)	0	1	4	-	8	1300x1200
ARX.08.21	-	4	120 (120Kg)	0	1	4	-	8	1300x1200

Braccio corto ARX.08.22

	Anta Singola LxH	Anta Doppia LxH	Punti di chiusura
Dimensioni Min	370x500	370x500	ARX.08.20
Dimensioni Max	600x1000	600x1000	ARX.08.20

Braccio Medio ARX.08.23

	Anta Singola LxH	Anta Doppia LxH	Punti di chiusura
Dimensioni Min	440x500	440x500	ARX.08.20
Dimensioni Max	600x1200	600x1200	ARX.08.20 + ARX.08.06
Dimensioni Max	600x2200	600x2200	ARX.08.20 + ARX.08.06 + Punto 1

Braccio Lungo ARX.08.24



	Anta Singola LxH	Anta Doppia LxH	Punti di chiusura
Dimensioni Min	601x1000	601x1000	ARX.08.20
Dimensioni Max	601x1200	601x1200	ARX.08.20 + ARX.08.06
Dimensioni Max	601x2200	601x2200	ARX.08.20 + ARX.08.06 + Punto 1
Dimensioni Max	1000x1200	1000x1200	ARX.08.21 + ARX.08.06 + Punto 1 e 2
Dimensioni Max	1000x2200	1000x2200	ARX.08.10 + ARX.08.06 + Punto 1 e 2
Dimensioni Max	1300x1200	-	ARX.08.21 + ARX.08.06 + Punto 1, 2 e 3
Dimensioni Max	1300x2200	-	ARX.08.21 + ARX.08.06 + Punto 1, 2 e 3

Legenda Stringa di Prodotto

Categoria D'uso (1)	Durabilità (2) Cicli	Massa (3)	Resistenza Fuoco (4)	Sicurezza D'uso (5)	Resistenza Corrosione (6)	Resistenza Effrazione (7)	Applicazione (8)	Dimensione di prova (9)
-	4:15.000 a/r+5.000 battente	Portata Certificazione	0: non idoneo	1: Soddisfatto	4: 240h UNI EN 1670:2008	-	8:Privato	Dimensione Campione di prova



Cerniere Anta Affiancata

ARX.08.15		Portata 120 Kg.
Kit cerniera a pettine		100%=120 Kg
ARX.08.25		Portata 120 Kg.
Kit cerniera a pettine regolabile		100%=120 Kg

H	2200	100%	100%	100%	100%	100%	100%	100%	100%	100%
	2100	100%	100%	100%	100%	100%	100%	100%	100%	100%
	2000	100%	100%	100%	100%	100%	100%	100%	100%	94%
	1900	100%	100%	100%	100%	100%	100%	100%	98%	86%
	1800	100%	100%	100%	100%	100%	100%	100%	90%	78%
	1700	100%	100%	100%	100%	100%	100%	95%	82%	71%
	1600	100%	100%	100%	100%	100%	100%	85%	73%	63%
	1500	100%	100%	100%	100%	100%	100%	76%	65%	55%
	1400	100%	100%	100%	96%	80%	67%	57%	N.D.	N.D.
	1300	100%	100%	100%	84%	70%	58%	N.D.	N.D.	N.D.
	1200	100%	100%	90%	73%	60%	N.D.	N.D.	N.D.	N.D.
	1100	100%	97%	78%	62%	50%	N.D.	N.D.	N.D.	N.D.
	1000	100%	83%	65%	51%	N.D.	N.D.	N.D.	N.D.	N.D.
		600	700	800	900	1000	1100	1200	1300	
	L									

Zona Bianco

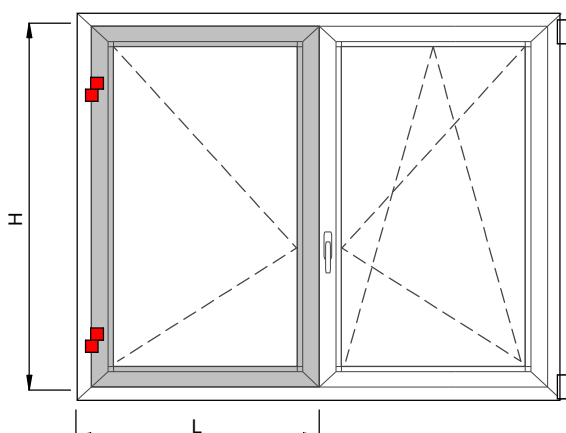

Zona Celeste

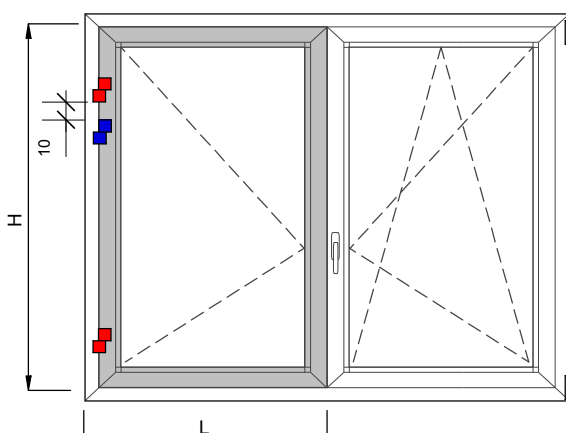





CX45.0933 Lamella 65 x 10 Peso kg/ml. 0.464 Perimetro mm. 141 Super. in vista m ² /m. 0.141 Jx 0.00 cm ⁴ Wx 0.00cm ³ Jy 0.00 cm ⁴ Wy 0.00 cm ³		Tavola B 20a	PX45.411 Fascia porte int. entrata 40.5 mm. Peso kg/ml. 1.428 Perimetro mm. 346 Super. in vista m ² /m. 0.200 Jx 0,00 cm ⁴ Wx 0,00 cm ³ Jy 0,00 cm ⁴ Wy 0,00 cm ³		Tavola B 30
CX45.419 Fascia entrata 35.3 mm. Peso kg/ml. 1.311 Perimetro mm. 342 Super. in vista m ² /m. 0.110 Jx 0.00 cm ⁴ Wx 0.00cm ³ Jy 0.00 cm ⁴ Wy 0.00 cm ³		Tavola B 20a	PX45.810 Imbotte porte interna mm.58.5 Peso kg/ml. 1,048 Perimetro mm. 367 Super. in vista m ² /m. 0.140 Jx 0.00 cm ⁴ Wx 0.00cm ³ Jy 0.00 cm ⁴ Wy 0.00 cm ³		Tavola B 19
CX45.620 Lamella 50 x 10 Peso kg/ml. 0.364 Perimetro mm. 111 Super. in vista m ² /m. 0.111 Jx 0.00 cm ⁴ Wx 0.00cm ³ Jy 0.00 cm ⁴ Wy 0.00 cm ³		Tavola B 20a	PX45.811 Imbotte porte interna mm.88.5 Peso kg/ml. 1,236 Perimetro mm. 427 Super. in vista m ² /m. 0.170 Jx 0.00 cm ⁴ Wx 0.00cm ³ Jy 0.00 cm ⁴ Wy 0.00 cm ³		Tavola B 19
CX45.621 Base per lamella Peso kg/ml. 0.308 Perimetro mm. 168 Super. in vista m ² /m. 0.024 Jx 0.00 cm ⁴ Wx 0.00cm ³ Jy 0.00 cm ⁴ Wy 0.00 cm ³		Tavola B 20a	PX45.812 Imbotte porte interna mm.118.5 Peso kg/ml. 1,436 Perimetro mm. 487 Super. in vista m ² /m. 0.200 Jx 0.00 cm ⁴ Wx 0.00cm ³ Jy 0.00 cm ⁴ Wy 0.00 cm ³		Tavola B 19
CX45.622 Lamella Perla 70 Peso kg/ml. 0.530 Perimetro mm. 160 Super. in vista m ² /m. 0.160 Jx 0.00 cm ⁴ Wx 0.00cm ³ Jy 0.00 cm ⁴ Wy 0.00 cm ³		Tavola B 20a	RX450.0099 Antina per zanzariera Peso kg/ml. 0.326 Perimetro mm. 162 Super. in vista m ² /m. 0.070 Jx 0.00 cm ⁴ Wx 0.00cm ³ Jy 0.00 cm ⁴ Wy 0.00 cm ³		Tavola B 14
CX45.623 Mezza -lamella Perla 70 Peso kg/ml. 0.448 Perimetro mm. 104 Super. in vista m ² /m. 0.104 Jx 0.00 cm ⁴ Wx 0.00cm ³ Jy 0.00 cm ⁴ Wy 0.00 cm ³		Tavola B 20a	RX450.0427 Anta scuretto interno Peso kg/ml. 0.474 Perimetro mm. 196 Super. in vista m ² /m. 0.087 Jx 1.42 cm ⁴ Wx 1.00cm ³ Jy 2.92 cm ⁴ Wy 1.03 cm ³		Tavola B 18
CX45.807 Prolunga da mm. 50 porte interne Peso kg/ml. 0.434 Perimetro mm. 207 Super. in vista m ² /m. 0.050 Jx 0.00 cm ⁴ Wx 0.00cm ³ Jy 0.00 cm ⁴ Wy 0.00 cm ³		Tavola B 19	RX450.1009 Gocciolatoio Peso kg/ml. 0.234 Perimetro mm. 84 Super. in vista m ² /m. 0.030 Jx 0.12 cm ⁴ Wx 0.16 cm ³ Jy 0.43 cm ⁴ Wy 0.36 cm ³		Tavola B 14

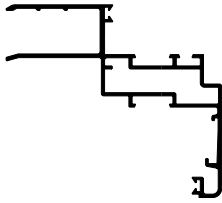

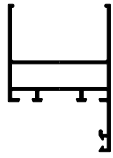

RX450.166			Tavola B 19
Telaio porta interna			
Peso	kg/ml. 1,476		
Perimetro	mm.		
Super. in vista	m ² /m. 0.118		
Jx 0.00 cm ⁴	Wx 0.00 cm ³		
Jy 0.00 cm ⁴	Wy 0.00 cm ³		

RX450.4544			Tavola B 30
Anta porte int. entrata 40.5 mm.			
Peso	kg/ml. 0,840		
Perimetro	mm. 343		
Super. in vista	m ² /m. 0.108		
Jx 0,00 cm ⁴	Wx 0,00 cm ³		
Jy 0,00 cm ⁴	Wy 0,00 cm ³		

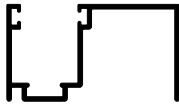
RX450.1342			Tavola B 14
Gocciolatoio			
Peso	kg/ml. 0.120		
Perimetro	mm. 67		
Super. in vista	m ² /m. 0.025		
Jx 0.03 cm ⁴	Wx 0.05 cm ³		
Jy 0.21 cm ⁴	Wy 0.19 cm ³		

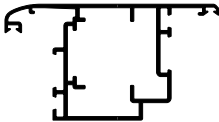
RX450.4595			Tavola B 20
Guida per tapparella			
Peso	kg/ml. 0,662		
Perimetro	mm. 332		
Super. in vista	m ² /m. 0.060		
Jx 0,00 cm ⁴	Wx 0,00 cm ³		
Jy 0,00 cm ⁴	Wy 0,00 cm ³		

RX450.214			Tavola B 18
Anta maggiorata doppia battuta			
Peso	kg/ml. 1,493		
Perimetro	mm. 701		
Super. in vista	m ² /m. 0.178		
Jx 20.94 cm ⁴	Wx 1.95 cm ³		
Jy 32.43 cm ⁴	Wy 2.43 cm ³		

RX450.5220			Tavola B 20a
Fascia chiusa persiana 35 x 80			
Peso	kg/ml. 1,170		
Perimetro	mm.		
Super. in vista	m ² /m. 0.230		
Jx 0.00 cm ⁴	Wx 0.00 cm ³		
Jy 0.00 cm ⁴	Wy 0.00 cm ³		

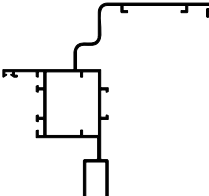
RX450.3141			Tavola B 10
Telaio per capannoni			
Peso	kg/ml. 1.959		
Perimetro	mm. 770		
Super. in vista	m ² /m. 0.223		
Jx 66.30 cm ⁴	Wx 8.42 cm ³		
Jy 106.21 cm ⁴	Wy 14.33 cm ³		

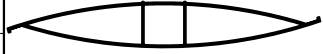
RX450.5247			Tavola B 17
Pala frangisole			
Peso	kg/ml. 1,700		
Perimetro	mm. 899		
Super. in vista	m ² /m. 0.440		
Jx 0.00 cm ⁴	Wx 0.00 cm ³		
Jy 0.00 cm ⁴	Wy 0.00 cm ³		

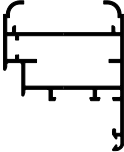
RX450.3498			Tavola B 20
Anta persiana scorniciata			
Peso	kg/ml. 1,017		
Perimetro	mm.		
Super. in vista	m ² /m. 0.103		
Jx 0.00 cm ⁴	Wx 0.00 cm ³		
Jy 0.00 cm ⁴	Wy 0.00 cm ³		

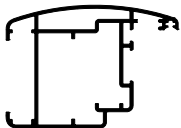
RX450.5632			Tavola B 18
Anta persiana grande tonda			
Peso	kg/ml. 1,499		
Perimetro	mm. 401		
Super. in vista	m ² /m. 0.177		
Jx 25,62 cm ⁴	Wx 7,45 cm ³		
Jy 28,17 cm ⁴	Wy 6,16 cm ³		

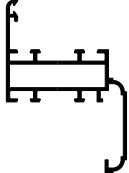





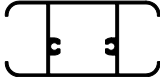



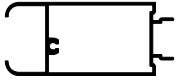

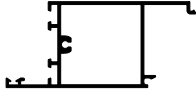
RX450.3614			Tavola B 20
Telaio scorniciato			
Peso	kg/ml. 0,988		
Perimetro	mm.		
Super. in vista	m ² /m. 0.116		
Jx 0.00 cm ⁴	Wx 0.00 cm ³		
Jy 0.00 cm ⁴	Wy 0.00 cm ³		

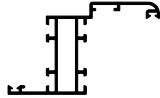
RX450.8291			Tavola B 29
Jolly compensazione			
Peso	kg/ml. 0.629		
Perimetro	mm. 231		
Super. in vista	m ² /m. 0.080		
Jx 0.70 cm ⁴	Wx 0.80 cm ³		
Jy 17.20 cm ⁴	Wy 3.45 cm ³		

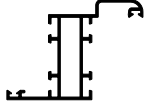

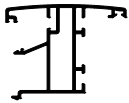
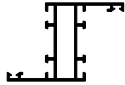

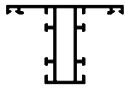

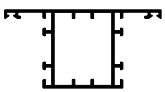
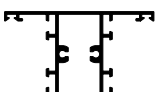
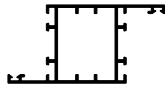
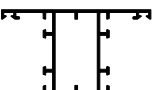
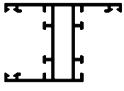
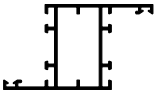

RX450.3570			Tavola B 20
Angolo variabile			
Peso	kg/ml. 0,922		
Perimetro	mm. 198		
Super. in vista	m ² /m. 0.060		
Jx 2,96 cm ⁴	Wx 1,25 cm ³		
Jy 11,43 cm ⁴	Wy 3,58 cm ³		

RX450.8326			Tavola B 12
Fascia piccola vetro ad infilare			
Peso	kg/ml. 1.257		
Perimetro	mm. 358		
Super. in vista	m ² /m. 0.198		
Jx 22.96 cm ⁴	Wx 5.43 cm ³		
Jy 10.74 cm ⁴	Wy 5.22 cm ³		

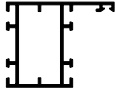

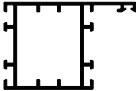

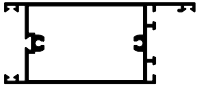
<p>RX450.8331</p> <p>Soprazzoccolo vetro ad infilare</p> <p>Peso kg/ml. 1.220</p> <p>Perimetro mm. 351</p> <p>Super. in vista m²/m. 0.180</p> <p>Jx 34.89 cm⁴ Wx 7.53 cm³</p> <p>Jy 11.39 cm⁴ Wy 5.62 cm³</p>		Tavola B 12	<p>RX500.8771</p> <p>Profilo per griglie</p> <p>Peso kg/ml. 0.302</p> <p>Perimetro mm. 141</p> <p>Super. in vista m²/m. 0.056</p> <p>Jx 00,00 cm⁴ Wx 00,00 cm³</p> <p>Jy 00,00 cm⁴ Wy 00,00 cm³</p>		Tavola B 26
<p>RX450.8363</p> <p>Soprazzoccolo</p> <p>Peso kg/ml. 1.191</p> <p>Perimetro mm. 383</p> <p>Super. in vista m²/m. 0.153</p> <p>Jx 26.68 cm⁴ Wx 5.04 cm³</p> <p>Jy 13.84 cm⁴ Wy 6.08 cm³</p>		Tavola B 13	<p>RX500.8772</p> <p>Sotto-struttura per griglie</p> <p>Peso kg/ml. 1.059</p> <p>Perimetro mm. 426</p> <p>Super. in vista m²/m. 0</p> <p>Jx 00,00 cm⁴ Wx 00,00 cm³</p> <p>Jy 00,00 cm⁴ Wy 00,00 cm³</p>		Tavola B 26
<p>RX450.8427</p> <p>Telaio piccolo complanare</p> <p>Peso kg/ml. 1.037</p> <p>Perimetro mm. 446</p> <p>Super. in vista m²/m. 0.127</p> <p>Jx 15.87 cm⁴ Wx 3.34 cm³</p> <p>Jy 14.59 cm⁴ Wy 5.35 cm³</p>		Tavola B 07	<p>RX450.9205</p> <p>Riduttore per vetro</p> <p>Peso kg/ml. 0.275</p> <p>Perimetro mm. 147</p> <p>Super. in vista m²/m. 0.012</p> <p>Jx 0.60 cm⁴ Wx 0.53 cm³</p> <p>Jy 0.58 cm⁴ Wy 0.47 cm³</p>		Tavola B 12
<p>RX450.8525</p> <p>Telaio piccolo complanare</p> <p>Peso kg/ml. 0.952</p> <p>Perimetro mm. 401</p> <p>Super. in vista m²/m. 0.113</p> <p>Jx 9.24 cm⁴ Wx 2.54 cm³</p> <p>Jy 12.59 cm⁴ Wy 4.51 cm³</p>		Tavola B 07	<p>RX450.9221</p> <p>Astina</p> <p>Peso kg/ml. 0.167</p> <p>Perimetro mm. 57</p> <p>Super. in vista m²/m. 0.015</p> <p>Jx 0.03 cm⁴ Wx 0.06 cm³</p> <p>Jy 0.20 cm⁴ Wy 0.22 cm³</p>		Tavola B 11
<p>RX450.8695</p> <p>Riporto centrale</p> <p>Peso kg/ml. 1.039</p> <p>Perimetro mm. 423</p> <p>Super. in vista m²/m. 0.110</p> <p>Jx 8.72 cm⁴ Wx 2.48 cm³</p> <p>Jy 11.19 cm⁴ Wy 3.62 cm³</p>		Tavola B 11	<p>RX450.9224</p> <p>Telaio a "Z"- Anta piccola</p> <p>Peso kg/ml. 0.886</p> <p>Perimetro mm. 365</p> <p>Super. in vista m²/m. 0.100</p> <p>Jx 9.77 cm⁴ Wx 4.34 cm³</p> <p>Jy 6.88 cm⁴ Wy 2.05 cm³</p>		Tavola B 07
<p>RX450.8709</p> <p>Porta lamella</p> <p>Peso kg/ml. 0.275</p> <p>Perimetro mm. 157</p> <p>Super. in vista m²/m. 0.025</p> <p>Jx 0.26 cm⁴ Wx 0.34 cm³</p> <p>Jy 1.29 cm⁴ Wy 0.70 cm³</p>		Tavola B 16	<p>RX450.9225</p> <p>Telaio a "T"- Traverso piccolo</p> <p>Peso kg/ml. 0.866</p> <p>Perimetro mm. 365</p> <p>Super. in vista m²/m. 0.100</p> <p>Jx 8.73 cm⁴ Wx 3.10 cm³</p> <p>Jy 6.88 cm⁴ Wy 2.05 cm³</p>		Tavola B 07
<p>RX450.8747</p> <p>Anta persiana piccola tonda</p> <p>Peso kg/ml. 1.266</p> <p>Perimetro mm. 377</p> <p>Super. in vista m²/m. 0.141</p> <p>Jx 20.81 cm⁴ Wx 5.94 cm³</p> <p>Jy 13.24 cm⁴ Wy 3.56 cm³</p>		Tavola B 18	<p>RX450.9226</p> <p>Telaio a "L" piccolo</p> <p>Peso kg/ml. 0.767</p> <p>Perimetro mm. 302</p> <p>Super. in vista m²/m. 0.073</p> <p>Jx 7.52 cm⁴ Wx 2.92 cm³</p> <p>Jy 3.69 cm⁴ Wy 1.24 cm³</p>		Tavola B 07



RX450.9227 Telaio a "T" grande Peso kg/ml. 1.180 Perimetro mm. 411 Super. in vista m ² /m. 0.146 Jx 13.38 cm ⁴ Wx 5.00 cm ³ Jy 20.84 cm ⁴ Wy 4.63 cm ³		Tavola B 09	RX450.9263 Traverso piccolo (mm.79) Peso kg/ml. 1.191 Perimetro mm. 388 Super. in vista m ² /m. 0.124 Jx 13.35 cm ⁴ Wx 3.38 cm ³ Jy 11.09 cm ⁴ Wy 4.16 cm ³		Tavola B 13
RX450.9228 Telaio a "Z" grande Peso kg/ml. 1.177 Perimetro mm. 411 Super. in vista m ² /m. 0.146 Jx 14.16 cm ⁴ Wx 6.29 cm ³ Jy 20.82 cm ⁴ Wy 4.63 cm ³		Tavola B 09	RX450.9264 Telaio a "T"- Traverso medio Peso kg/ml. 1.026 Perimetro mm. 389 Super. in vista m ² /m. 0.124 Jx 10.97 cm ⁴ Wx 4.01 cm ³ Jy 12.79 cm ⁴ Wy 3.24 cm ³		Tavola B 09
RX450.9229 Telaio a "H" piccolo Peso kg/ml. 1.004 Perimetro mm. 429 Super. in vista m ² /m. 0.127 Jx 11.48 cm ⁴ Wx 4.60 cm ³ Jy 9.35 cm ⁴ Wy 2.57 cm ³		Tavola B 07	RX450.9265 Telaio a "Z"- Anta media Peso kg/ml. 1.026 Perimetro mm. 389 Super. in vista m ² /m. 0.124 Jx 11.87 cm ⁴ Wx 5.28 cm ³ Jy 12.77 cm ⁴ Wy 3.23 cm ³		Tavola B 09
RX450.9230 Traverso - Fascia (mm.118) Peso kg/ml. 1.617 Perimetro mm. 467 Super. in vista m ² /m. 0.202 Jx 59.48 cm ⁴ Wx 10.08 cm ³ Jy 18.14 cm ⁴ Wy 7.09 cm ³		Tavola B 13	RX450.9266 Telaio a "L" medio Peso kg/ml. 0.907 Perimetro mm. 325 Super. in vista m ² /m. 0.097 Jx 9.67 cm ⁴ Wx 3.83 cm ³ Jy 8.02 cm ⁴ Wy 2.26 cm ³		Tavola B 09
RX450.9232 Traverso - Fascia (mm.158) Peso kg/ml. 2.063 Perimetro mm. 543 Super. in vista m ² /m. 0.282 Jx 157.88 cm ⁴ Wx 19.99 cm ³ Jy 25.63 cm ⁴ Wy 10.29 cm ³		Tavola B 13	RX450.9269 Telaio a "L" grande Peso kg/ml. 1.061 Perimetro mm. 347 Super. in vista m ² /m. 0.119 Jx 11.99 cm ⁴ Wx 4.83 cm ³ Jy 14.38 cm ⁴ Wy 3.51 cm ³		Tavola B 09
RX450.9261 Zoccolo (mm.146) Peso kg/ml. 2.017 Perimetro mm. 518 Super. in vista m ² /m. 0.275 Jx 150.54 cm ⁴ Wx 19.26 cm ³ Jy 25.57 cm ⁴ Wy 10.77 cm ³		Tavola B 15	RX450.9284 Profilo finitura Peso kg/ml. 0.235 Perimetro mm. 148 Super. in vista m ² /m. 0.061 Jx 0.53 cm ⁴ Wx 0.28 cm ³ Jy 1.82 cm ⁴ Wy 0.63 cm ³		Tavola B 14
RX450.9262 Zoccolo (mm.106) Peso kg/ml. 1.596 Perimetro mm. 433 Super. in vista m ² /m. 0.275 Jx 56.51 cm ⁴ Wx 9.71 cm ³ Jy 18.27 cm ⁴ Wy 7.59 cm ³		Tavola B 15	RX450.9303 Controtelaio di compensazione Peso kg/ml. 0.462 Perimetro mm. 240 Super. in vista m ² /m. 0.058 Jx 1.00 cm ⁴ Wx 0.49 cm ³ Jy 6.05 cm ⁴ Wy 2.50 cm ³		Tavola B 20

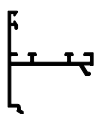
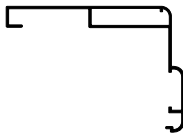
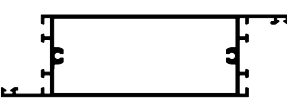
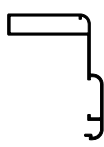
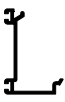
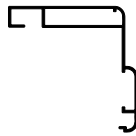
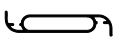
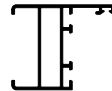
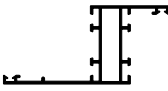
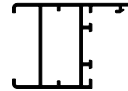
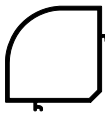
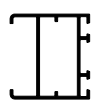
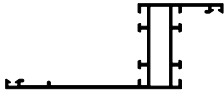

RX450.9304 Inversione di battuta Peso kg/ml. 0.607 Perimetro mm. 293 Super. in vista m ² /m. 0.062 Jx 3.16 cm ⁴ Wx 1.13 cm ³ Jy 5.60 cm ⁴ Wy 1.87 cm ³		Tavola B 14	RX450.9600 Imbotte per porte Peso kg/ml. 1.102 Perimetro mm. 441 Super. in vista m ² /m. 0.186 Jx 23.98 cm ⁴ Wx 4.26 cm ³ Jy 51.36 cm ⁴ Wy 7.21 cm ³		Tavola B 29
RX450.9307 Zoccolo con battuta Peso kg/ml. 2.060 Perimetro mm. 547 Super. in vista m ² /m. 0.282 Jx 157.73 cm ⁴ Wx 19.97 cm ³ Jy 26.07 cm ⁴ Wy 11.59 cm ³		Tavola B 14	RX450.9601 Imbotte per porte Peso kg/ml. 0.820 Perimetro mm. 302 Super. in vista m ² /m. 0.136 Jx 19.42 cm ⁴ Wx 3.87 cm ³ Jy 10.88 cm ⁴ Wy 2.83 cm ³		Tavola B 29
RX450.9308 Profilo per porte a ventola Peso kg/ml. 0.421 Perimetro mm. 203 Super. in vista m ² /m. 0.083 Jx 1.03 cm ⁴ Wx 0.47 cm ³ Jy 4.18 cm ⁴ Wy 1.54 cm ³		Tavola B 14	RX450.9602 Imbotte per porte Peso kg/ml. 0.980 Perimetro mm. 381 Super. in vista m ² /m. 0.156 Jx 21.97 cm ⁴ Wx 4.08 cm ³ Jy 24.66 cm ⁴ Wy 4.88 cm ³		Tavola B 29
RX450.9392 Lamella persiana Peso kg/ml. 0.413 Perimetro mm. 180 Super. in vista m ² /m. 0.124 Jx 0.22 cm ⁴ Wx 0.32cm ³ Jy 5.26 cm ⁴ Wy 1.75 cm ³		Tavola B 16	RX450.9618 Anta porta interna piccola Peso kg/ml. 0.779 Perimetro mm. 307 Super. in vista m ² /m. 0.096 Jx 8.60 cm ⁴ Wx 3.36 cm ³ Jy 4.49 cm ⁴ Wy 1.46 cm ³		Tavola B 16
RX450.9479 Telaio battuta lunga Peso kg/ml. 1.023 Perimetro mm. 424 Super. in vista m ² /m. 0.128 Jx 11.85 cm ⁴ Wx 4.66 cm ³ Jy 18.84 cm ⁴ Wy 3.46 cm ³		Tavola B 08	RX450.9619 Anta porta interna media Peso kg/ml. 0.925 Perimetro mm. 327 Super. in vista m ² /m. 0.120 Jx 10.59 cm ⁴ Wx 4.22 cm ³ Jy 8.32 cm ⁴ Wy 2.33 cm ³		Tavola B 16
RX450.9525 Profilo angolo Peso kg/ml. 1.037 Perimetro mm. 217 Super. in vista m ² /m. 0.096 Jx 14.04 cm ⁴ Wx 5.10 cm ³ Jy 14.04 cm ⁴ Wy 5.10 cm ³		Tavola B 20	RX450.9620 Anta porta interna media Peso kg/ml. 0.809 Perimetro mm. 263 Super. in vista m ² /m. 0.084 Jx 8.93 cm ⁴ Wx 3.97 cm ³ Jy 4.75 cm ⁴ Wy 1.94 cm ³		Tavola B 16
RX450.9526 Telaio battuta lunga Peso kg/ml. 1.112 Perimetro mm. 463 Super. in vista m ² /m. 0.148 Jx 12.89 cm ⁴ Wx 4.79 cm ³ Jy 34.30 cm ⁴ Wy 4.99 cm ³		Tavola B 08	RX450.9621 Fascia-zoccolo porta interna Peso kg/ml. 1.234 Perimetro mm. 321 Super. in vista m ² /m. 0.190 Jx 36.20 cm ⁴ Wx 7.87 cm ³ Jy 12.04 cm ⁴ Wy 6.02 cm ³		Tavola B 16



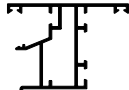

RX450.9627			Tavola B 16
Compensatore lamella			
Peso	kg/ml. 0.431		
Perimetro	mm. 165		
Super. in vista	m ² /m. 0.044		
Jx 1.97 cm ⁴ Wx 1.00 cm ³ Jy 1.84 cm ⁴ Wy 0.76 cm ³			

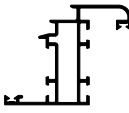
RX450.9658			Tavola B 11
Riporto centrale PLUS			
Peso	kg/ml. 0.969		
Perimetro	mm. 387		
Super. in vista	m ² /m. 0.074		
Jx 7.83 cm ⁴ Wx 2.20 cm ³ Jy 10.28 cm ⁴ Wy 3.52 cm ³			

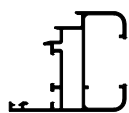
RX450.9659			Tavola B 11
Anta piccola PLUS			
Peso	kg/ml. 0.995		
Perimetro	mm. 417		
Super. in vista	m ² /m. 0.105		
Jx 8.44 cm ⁴ Wx 2.40 cm ³ Jy 13.22 cm ⁴ Wy 4.90 cm ³			

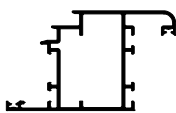
RX450.9660			Tavola B 12
Anta piccola vetro inf. PLUS			
Peso	kg/ml. 1.016		
Perimetro	mm. 400		
Super. in vista	m ² /m. 0.135		
Jx 9.07 cm ⁴ Wx 2.51 cm ³ Jy 14.05 cm ⁴ Wy 4.59 cm ³			

RX450.9662			Tavola B 11
Anta grande PLUS			
Peso	kg/ml. 1.350		
Perimetro	mm. 463		
Super. in vista	m ² /m. 0.136		
Jx 24.93 cm ⁴ Wx 5.31 cm ³ Jy 19.95 cm ⁴ Wy 7.51 cm ³			

RX450.9698			Tavola B 08
Telaio chiuso			
Peso	kg/ml. 0.640		
Perimetro	mm. 241		
Super. in vista	m ² /m. 0.108		
Jx 2.67 cm ⁴ Wx 0.98 cm ³ Jy 6.21 cm ⁴ Wy 2.35 cm ³			

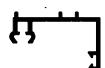
XX70.602			Tavola B 15
Gocciolatoio			
Peso	kg/ml. 0.372		
Perimetro	mm. 191		
Super. in vista	m ² /m. 0.022		
Jx 0.70 cm ⁴ Wx 0.41 cm ³ Jy 2.64 cm ⁴ Wy 1.20 cm ³			

XX70.603			Tavola B 15
Gocciolatoio			
Peso	kg/ml. 0.275		
Perimetro	mm. 107		
Super. in vista	m ² /m. 0.040		
Jx 0.00 cm ⁴ Wx 0.00 cm ³ Jy 0.00 cm ⁴ Wy 0.00 cm ³			

RX450.8755			Tavola 22
Fermavetro dritto mm. 9			
Peso	kg/ml. 0.262		
Jx 00.00 cm ⁴ Wx 0.00 cm ³ Jy 00.00 cm ⁴ Wy 0.00 cm ³			

RX450.9186			Tavola 22
Fermavetro dritto mm. 2			
Peso	kg/ml. 0.197		
Jx 00.00 cm ⁴ Wx 0.00 cm ³ Jy 00.00 cm ⁴ Wy 0.00 cm ³			

RX450.9431			Tavola 22
Fermavetro dritto mm. 10			
Peso	kg/ml. 0.248		
Jx 00.00 cm ⁴ Wx 0.00 cm ³ Jy 00.00 cm ⁴ Wy 0.00 cm ³			

RX450.9499			Tavola 22
Fermavetro dritto mm. 5			
Peso	kg/ml. 0.203		
Jx 00.00 cm ⁴ Wx 0.00 cm ³ Jy 00.00 cm ⁴ Wy 0.00 cm ³			

RX450.9530			Tavola 22
Fermavetro dritto mm. 17			
Peso	kg/ml. 0.276		
Jx 00.00 cm ⁴ Wx 0.00 cm ³ Jy 00.00 cm ⁴ Wy 0.00 cm ³			

RX70.501			Tavola 22
Fermavetro tondo mm. 14			
Peso	kg/ml. 0.262		
Jx 00.00 cm ⁴ Wx 0.00 cm ³ Jy 00.00 cm ⁴ Wy 0.00 cm ³			

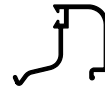
RX70.502			Tavola 22
Fermavetro tondo mm. 18			
Peso	kg/ml. 0.265		
Jx 00.00 cm ⁴ Wx 0.00 cm ³ Jy 00.00 cm ⁴ Wy 0.00 cm ³			



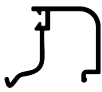

RX70.503			Tavola 22
Fermavetro tondo mm. 22			
Peso	kg/ml. 0.275		
Jx 00.00 cm4	Wx 0.00 cm3		
Jy 00.00 cm4	Wy 0.00 cm3		

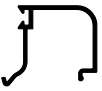
RX70.551			Tavola 23
Fermavetro tondo per clip mm.14			
Peso	kg/ml. 0.280		
Jx 00.00 cm4	Wx 0.00 cm3		
Jy 00.00 cm4	Wy 0.00 cm3		

RX70.504			Tavola 22
Fermavetro tondo mm. 26			
Peso	kg/ml. 0.292		
Jx 00.00 cm4	Wx 0.00 cm3		
Jy 00.00 cm4	Wy 0.00 cm3		

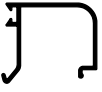
RX70.552			Tavola 23
Fermavetro tondo per clip mm.18			
Peso	kg/ml. 0.297		
Jx 00.00 cm4	Wx 0.00 cm3		
Jy 00.00 cm4	Wy 0.00 cm3		

RX70.505			Tavola 22
Fermavetro tondo mm. 30			
Peso	kg/ml. 0.280		
Jx 00.00 cm4	Wx 0.00 cm3		
Jy 00.00 cm4	Wy 0.00 cm3		

RX70.553			Tavola 23
Fermavetro tondo per clip mm.22			
Peso	kg/ml. 0.308		
Jx 00.00 cm4	Wx 0.00 cm3		
Jy 00.00 cm4	Wy 0.00 cm3		

RX70.506			Tavola 22
Fermavetro diritto mm. 14			
Peso	kg/ml. 0.270		
Jx 00.00 cm4	Wx 0.00 cm3		
Jy 00.00 cm4	Wy 0.00 cm3		

RX70.554			Tavola 23
Fermavetro tondo per clip mm.26			
Peso	kg/ml. 0.332		
Jx 00.00 cm4	Wx 0.00 cm3		
Jy 00.00 cm4	Wy 0.00 cm3		

RX70.507			Tavola 22
Fermavetro diritto mm. 18			
Peso	kg/ml. 0.275		
Jx 00.00 cm4	Wx 0.00 cm3		
Jy 00.00 cm4	Wy 0.00 cm3		

RX70.555			Tavola 23
Fermavetro tondo per clip mm.30			
Peso	kg/ml. 0.350		
Jx 00.00 cm4	Wx 0.00 cm3		
Jy 00.00 cm4	Wy 0.00 cm3		

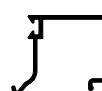

RX70.508			Tavola 22
Fermavetro diritto mm. 22			
Peso	kg/ml. 0.280		
Jx 00.00 cm4	Wx 0.00 cm3		
Jy 00.00 cm4	Wy 0.00 cm3		

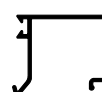
RX70.509			Tavola 22
Fermavetro diritto mm. 26			
Peso	kg/ml. 0.299		
Jx 00.00 cm4	Wx 0.00 cm3		
Jy 00.00 cm4	Wy 0.00 cm3		

RX70.510			Tavola 22
Fermavetro diritto mm. 30			
Peso	kg/ml. 0.289		
Jx 00.00 cm4	Wx 0.00 cm3		
Jy 00.00 cm4	Wy 0.00 cm3		

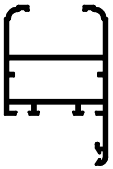
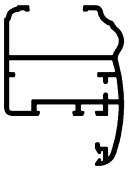
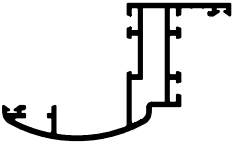
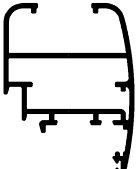

Linea **FG**

RX450.FG50			Tavola 27
Anta D.B. entrata 24 mm.			
Peso	kg/ml. 0.946		
Perimetro	mm. 373		
Super. in vista	m ² /m. 0.135		
Jx 0.00 cm ⁴ Wx 0.00 cm ³ Jy 0.00 cm ⁴ Wy 0.00 cm ³			
RX450.FG53			Tavola 28
Anta persiana entrata 24 mm.			
Peso	kg/ml. 1.163		
Perimetro	mm. 417		
Super. in vista	m ² /m. 0.150		
Jx 0.00 cm ⁴ Wx 0.00 cm ³ Jy 0.00 cm ⁴ Wy 0.00 cm ³			
RX450.FG55			Tavola 28
Telaio sagomato battuta 55 mm.			
Peso	kg/ml. 1.189		
Perimetro	mm. 478		
Super. in vista	m ² /m. 0.155		
Jx 0.00 cm ⁴ Wx 0.00 cm ³ Jy 0.00 cm ⁴ Wy 0.00 cm ³			
RX450.FG56			Tavola 28
Anta sagomata G.A. entr. 24 mm.			
Peso	kg/ml. 1.258		
Perimetro	mm. 436		
Super. in vista	m ² /m. 0.148		
Jx 0.00 cm ⁴ Wx 0.00 cm ³ Jy 0.00 cm ⁴ Wy 0.00 cm ³			
RX450.FG57			Tavola 27
Fascia persiana entrata 24 mm.			
Peso	kg/ml. 1.163		
Perimetro	mm. 417		
Super. in vista	m ² /m. 0.150		
Jx 0.00 cm ⁴ Wx 0.00 cm ³ Jy 0.00 cm ⁴ Wy 0.00 cm ³			

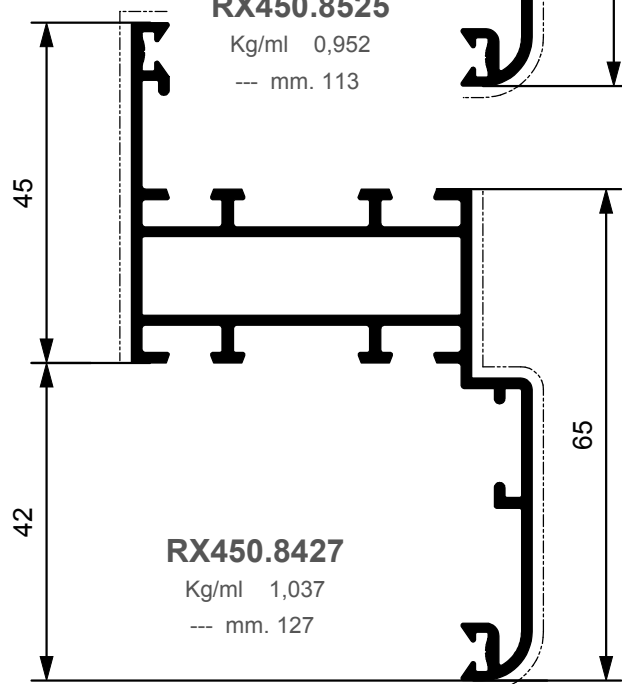
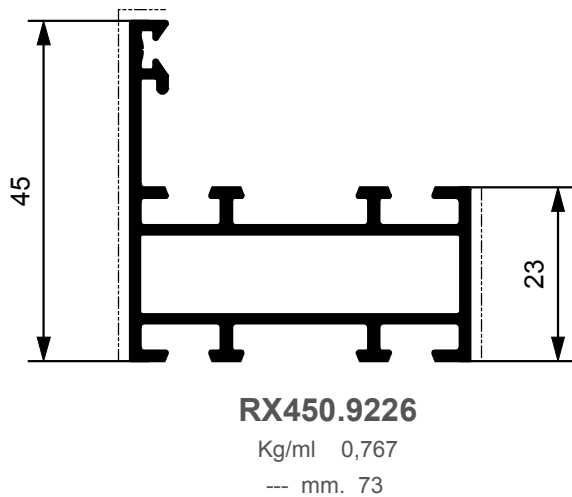
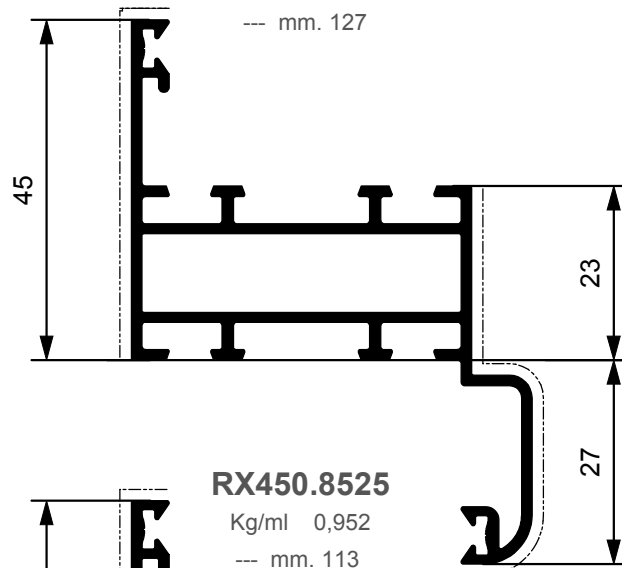
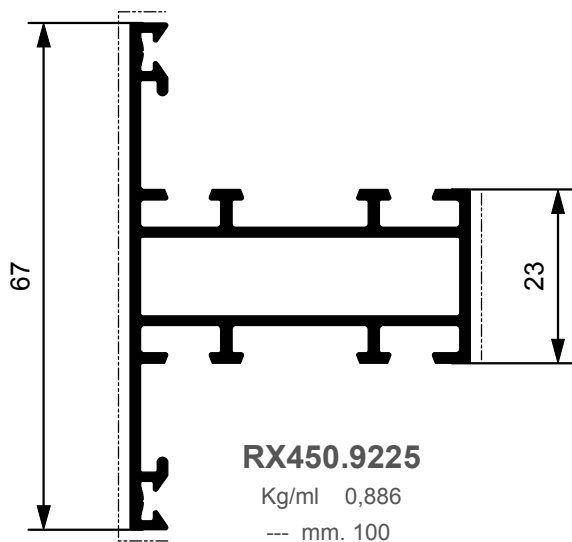
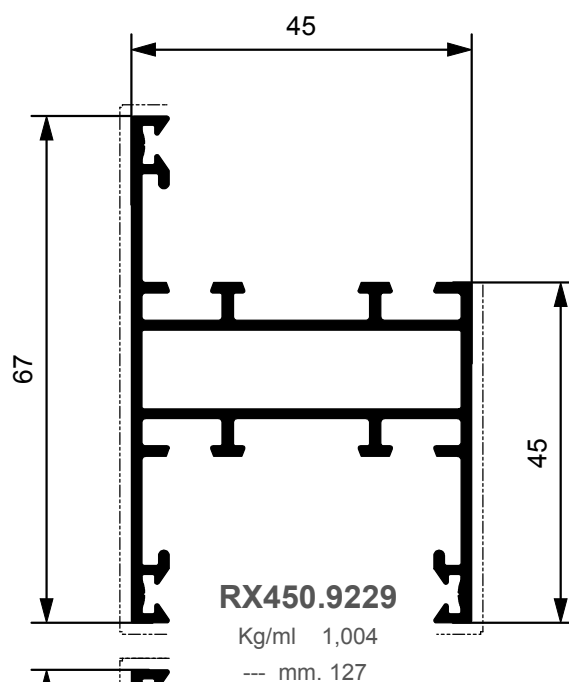
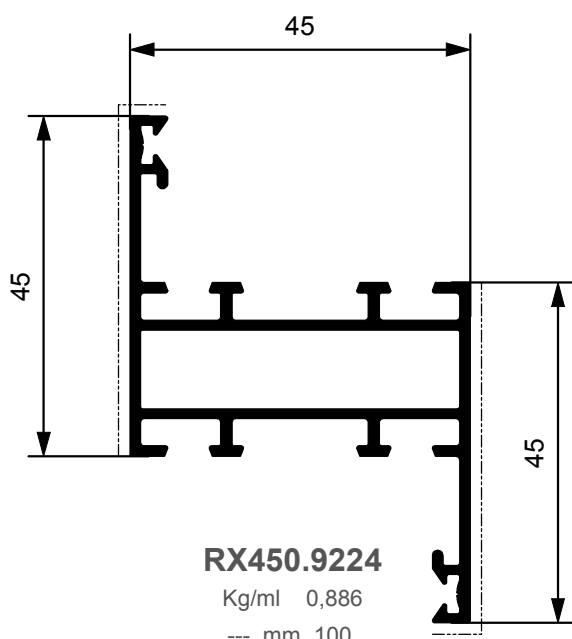

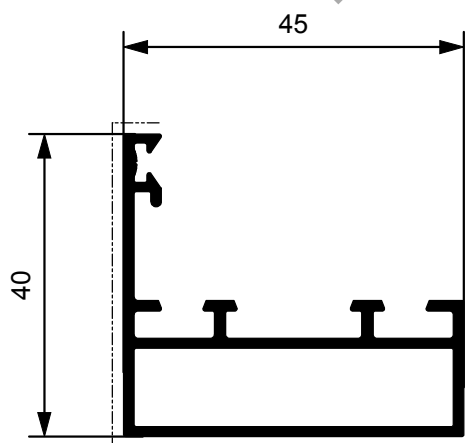

RX450.9698

Kg/ml 0,640
--- mm. 108

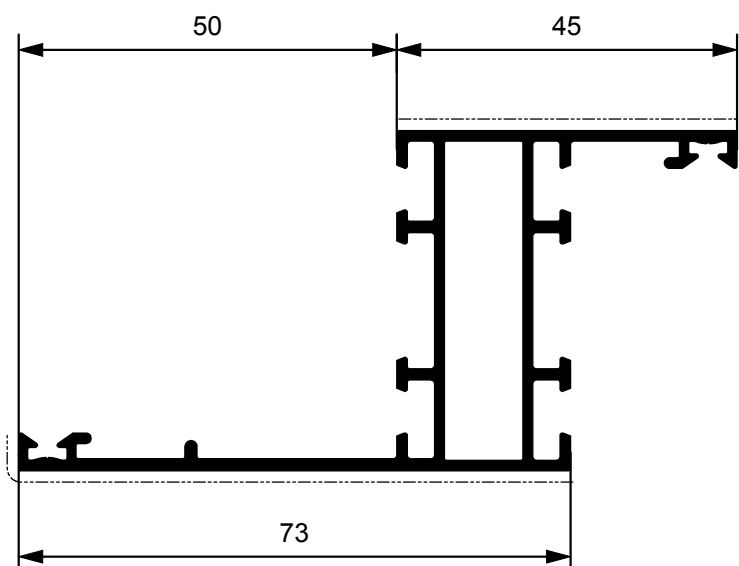

RX450.9479

Kg/ml 1,023
--- mm. 113

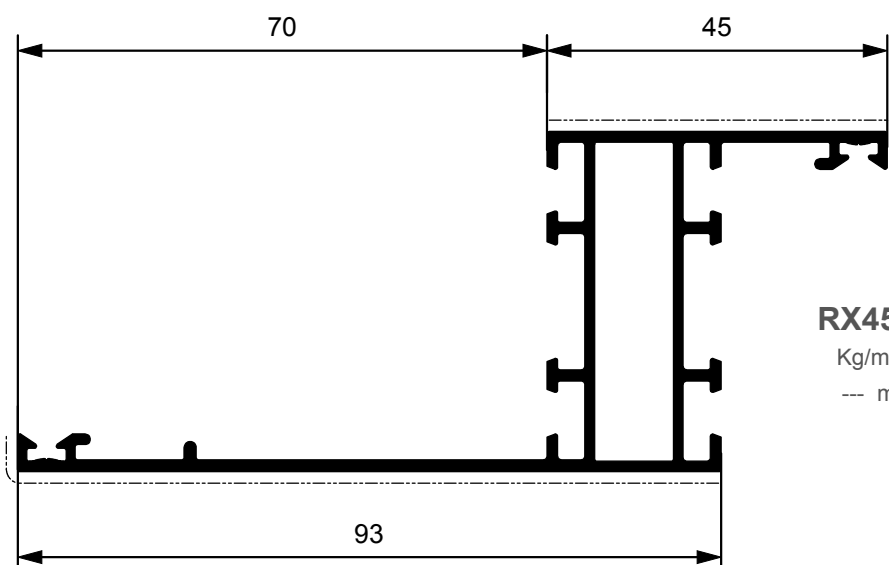

RX450.9526

Kg/ml 1,112
--- mm. 148

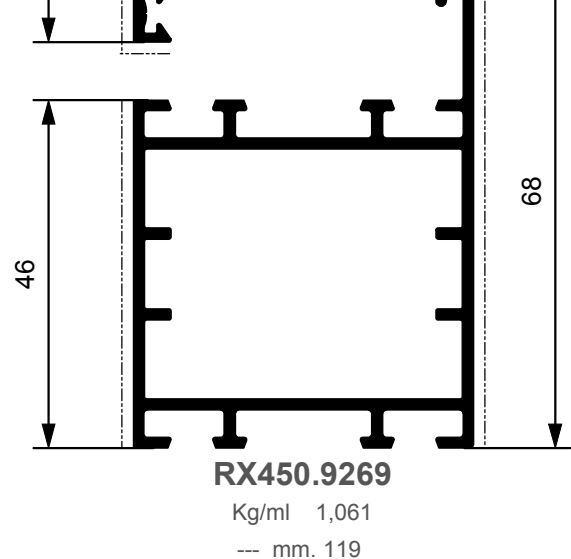
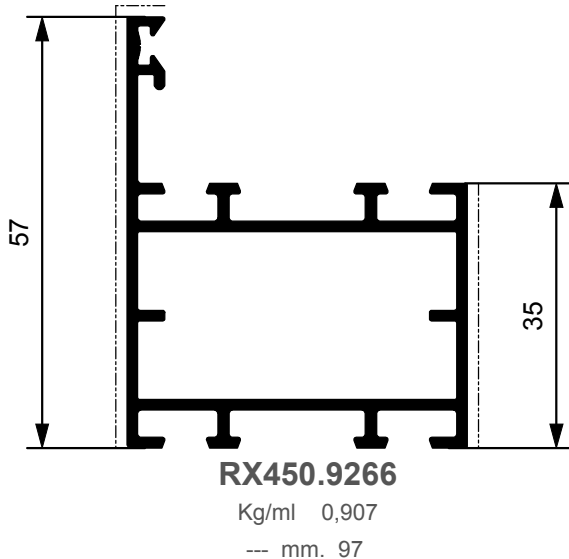
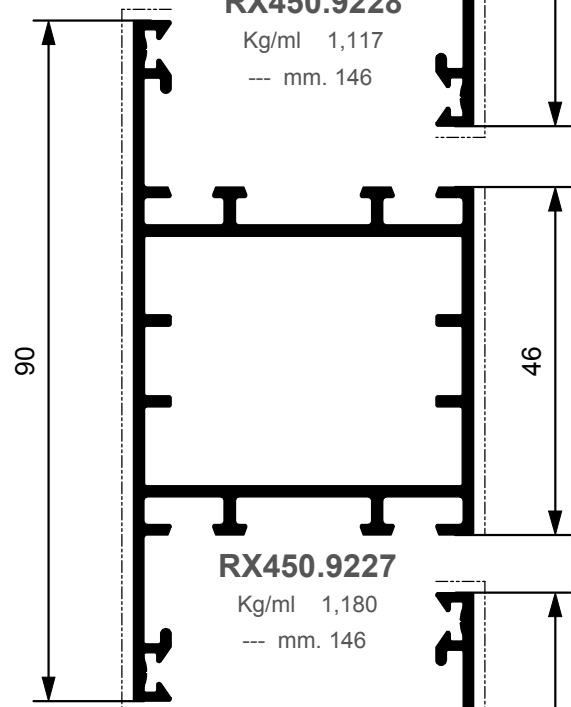
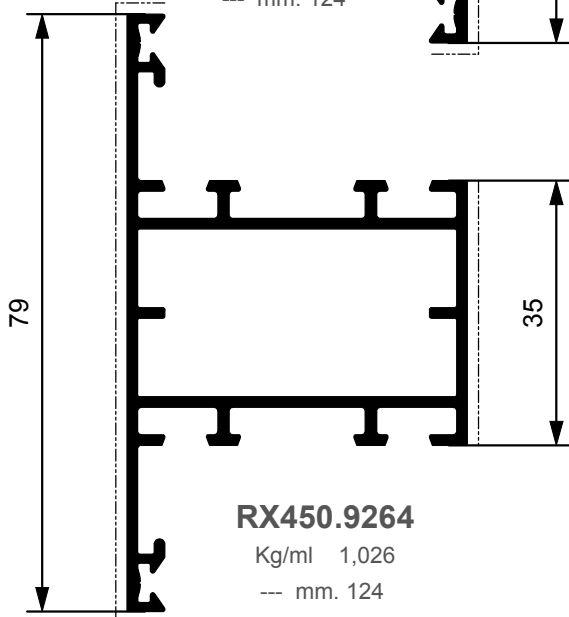
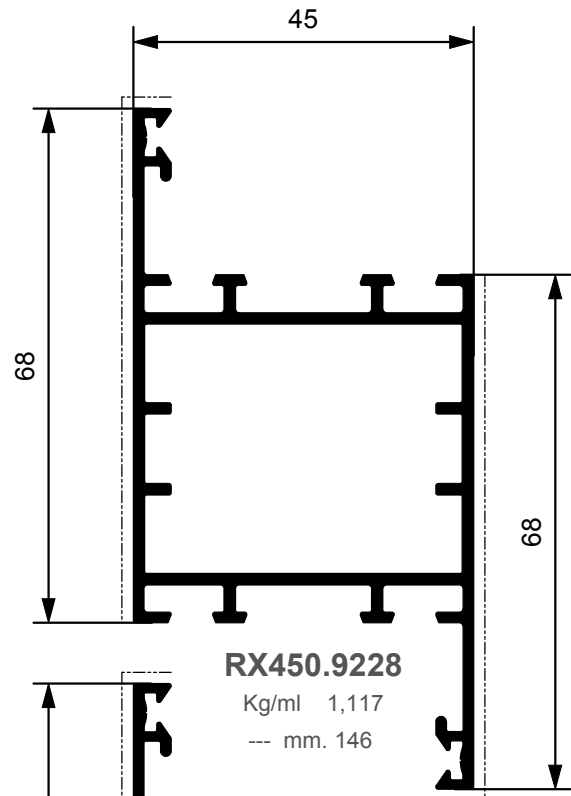
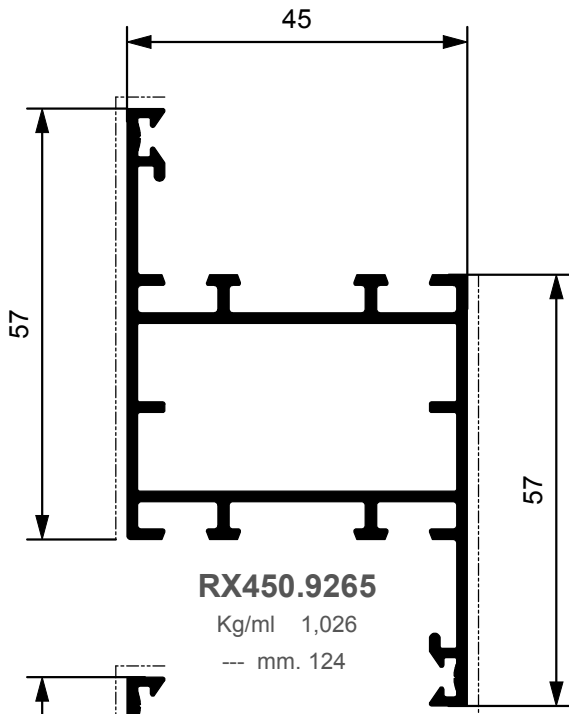

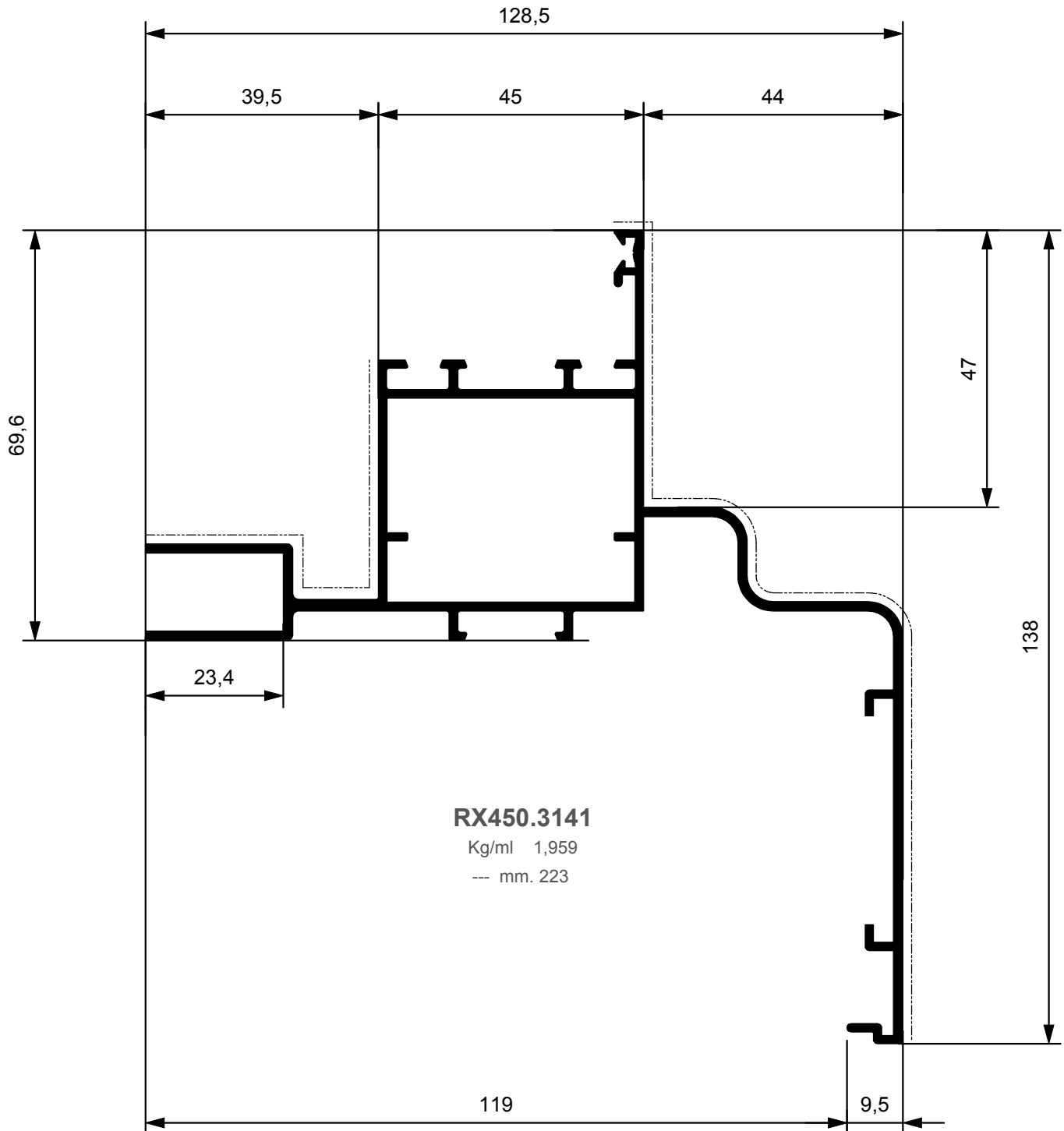

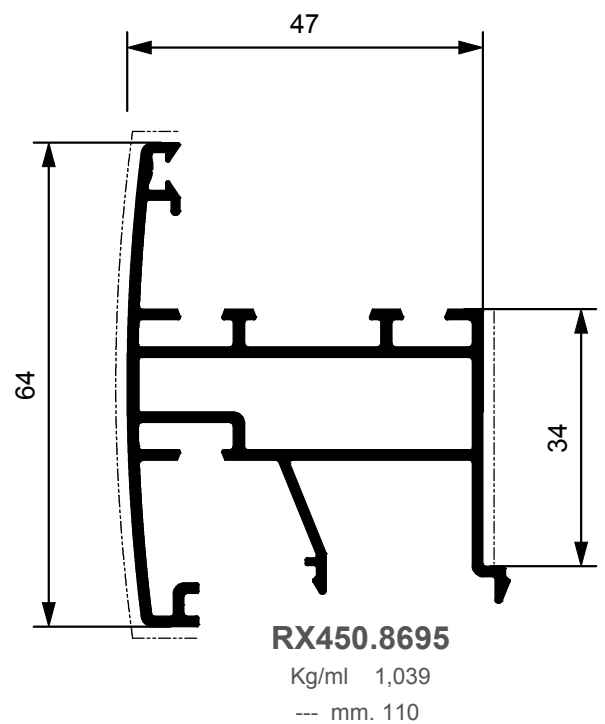
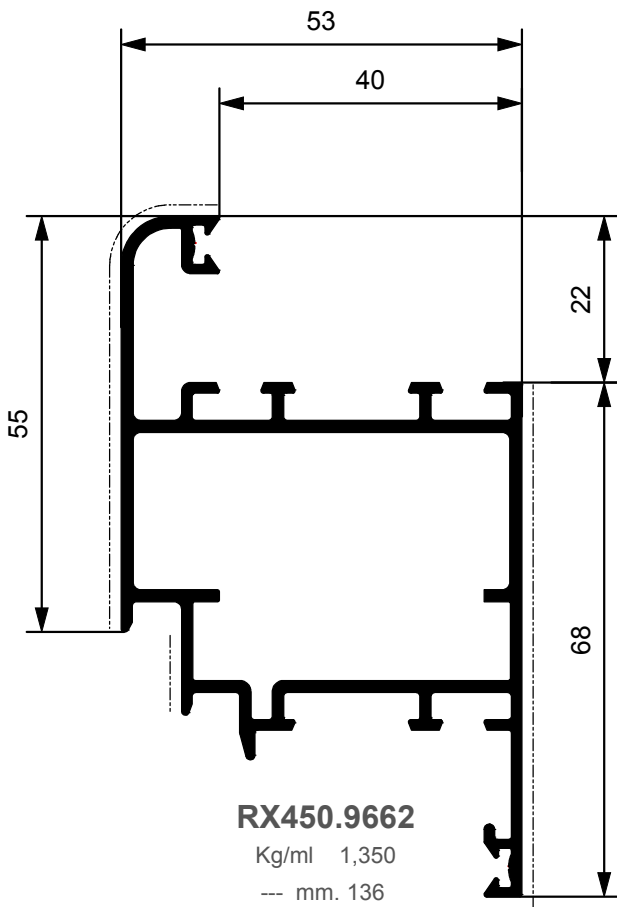
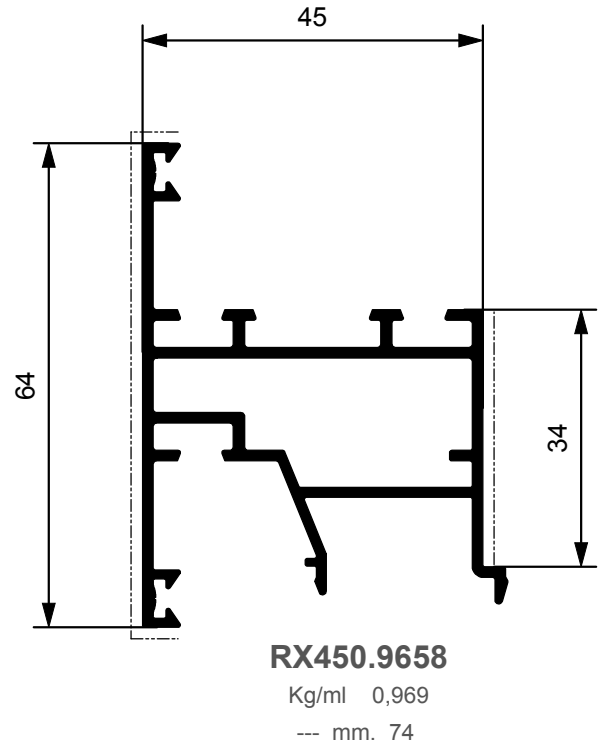
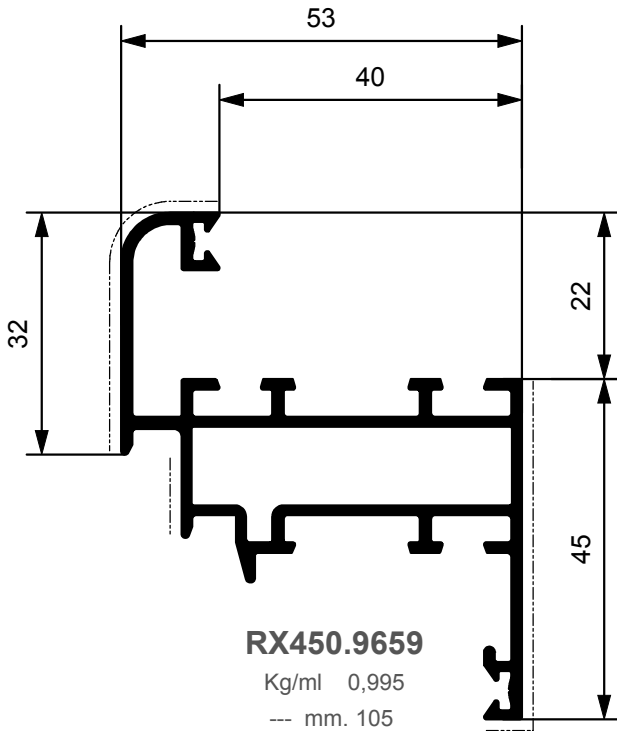

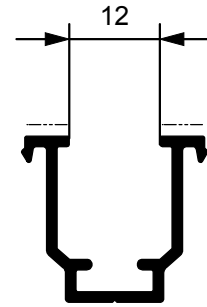
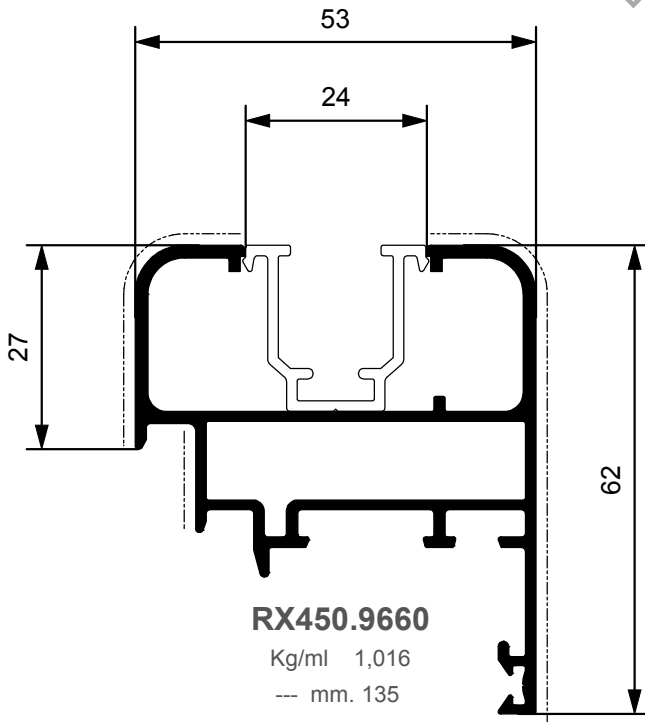

RX450.9205
Kg/ml 0,275
--- mm. 12

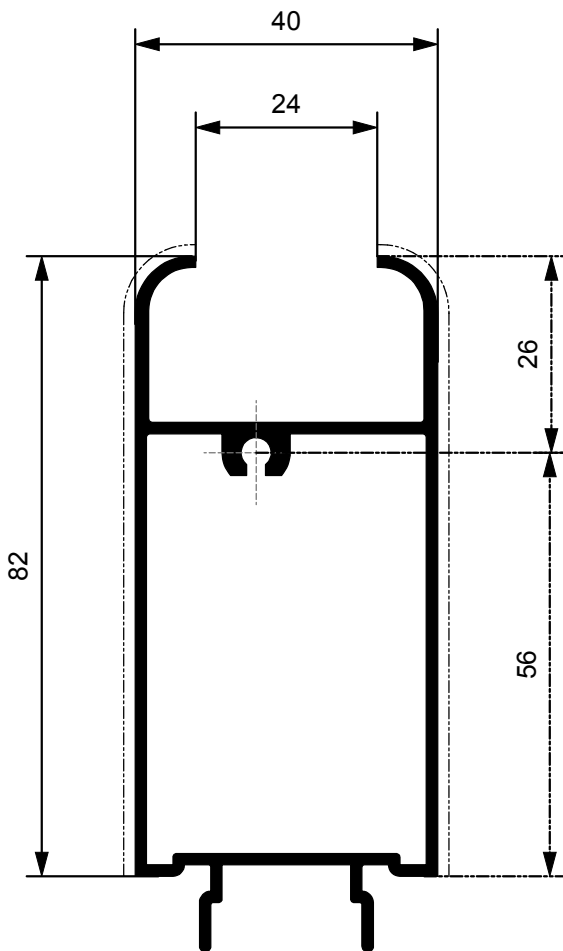

RX450.8331
Kg/ml 1,220
--- mm. 180

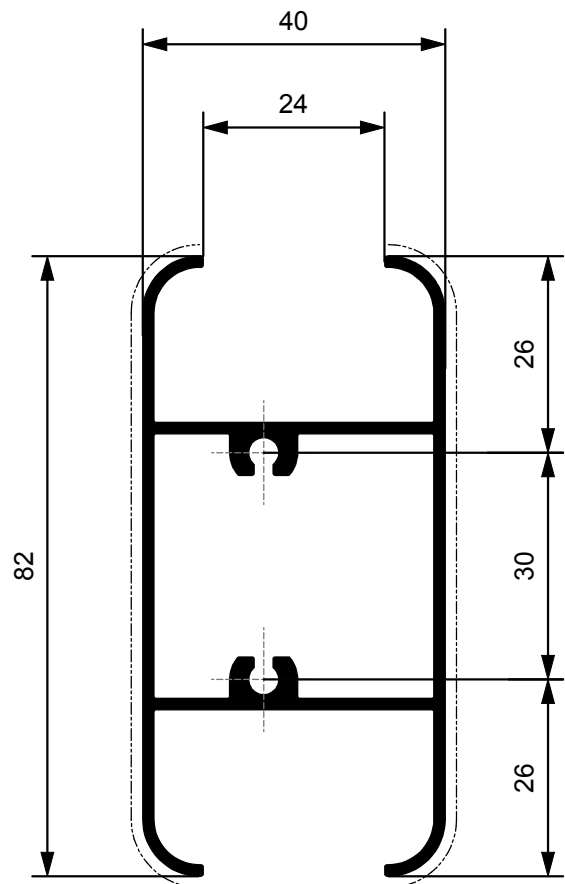

RX450.8326
Kg/ml 1,257
--- mm. 198

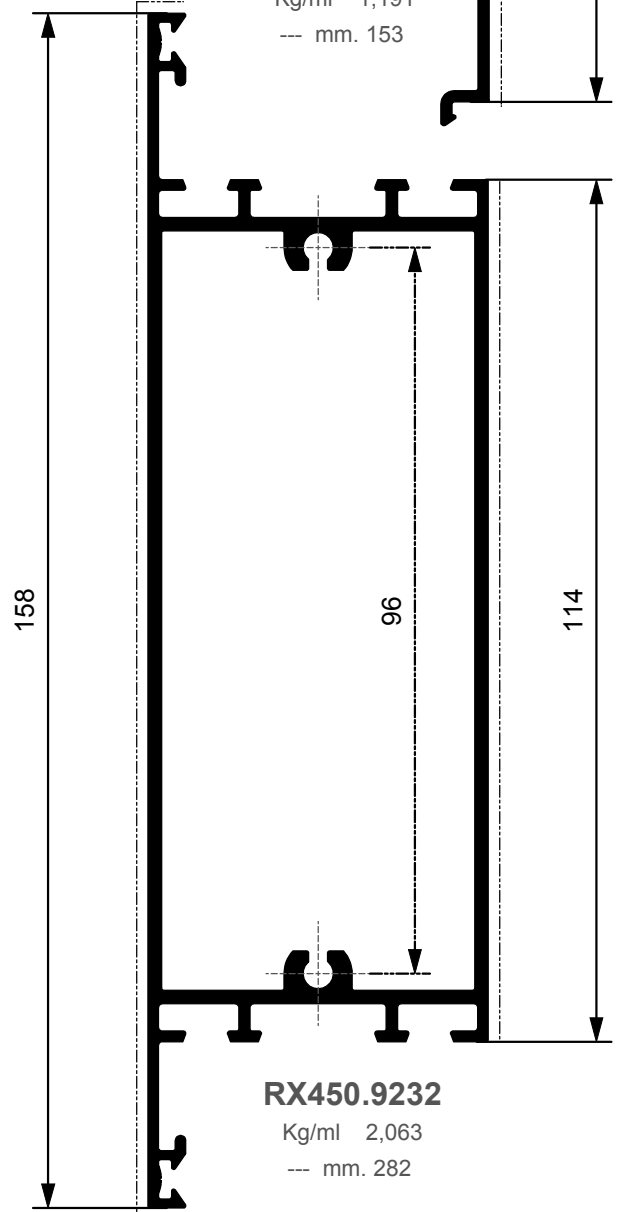
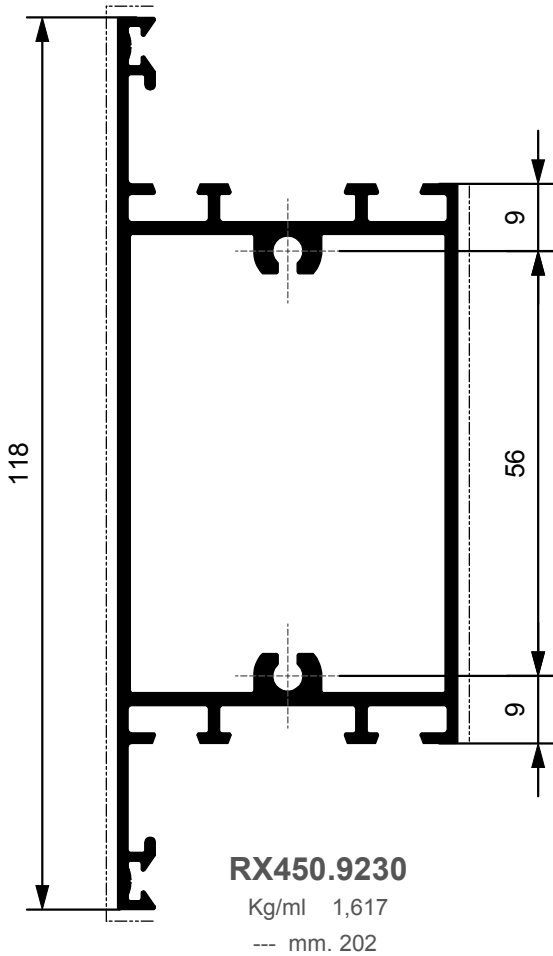
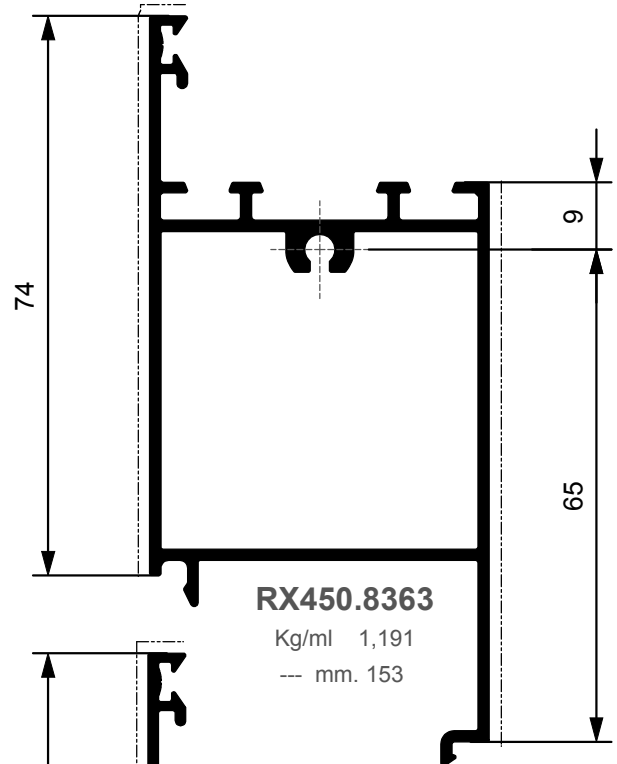
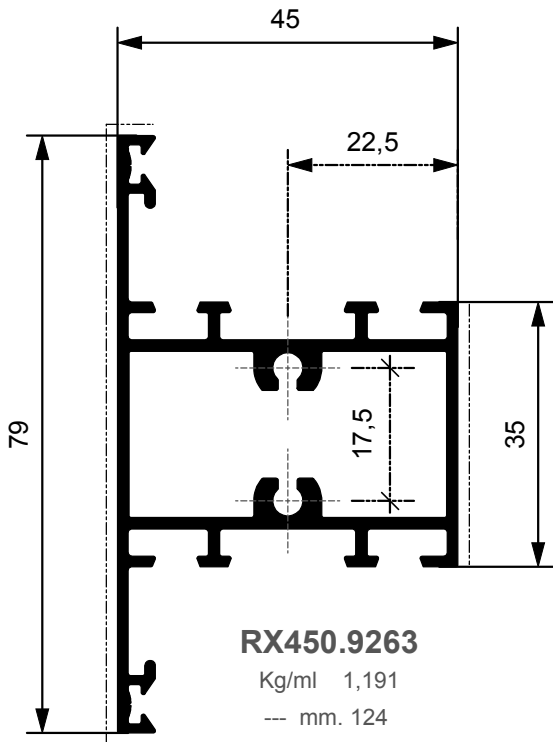

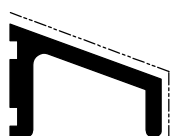
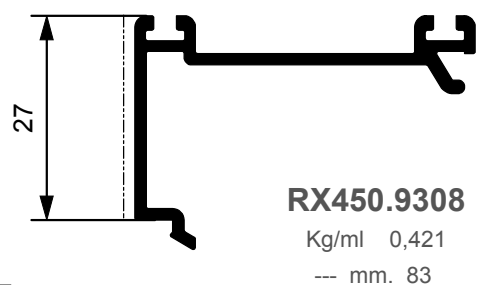
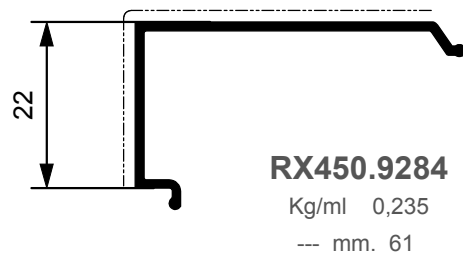
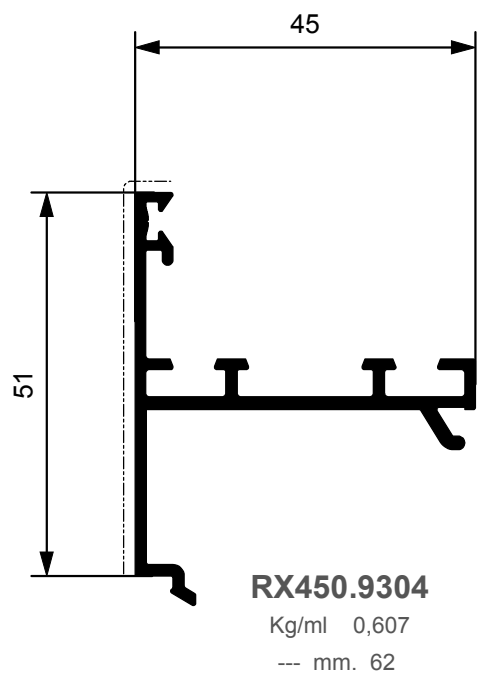
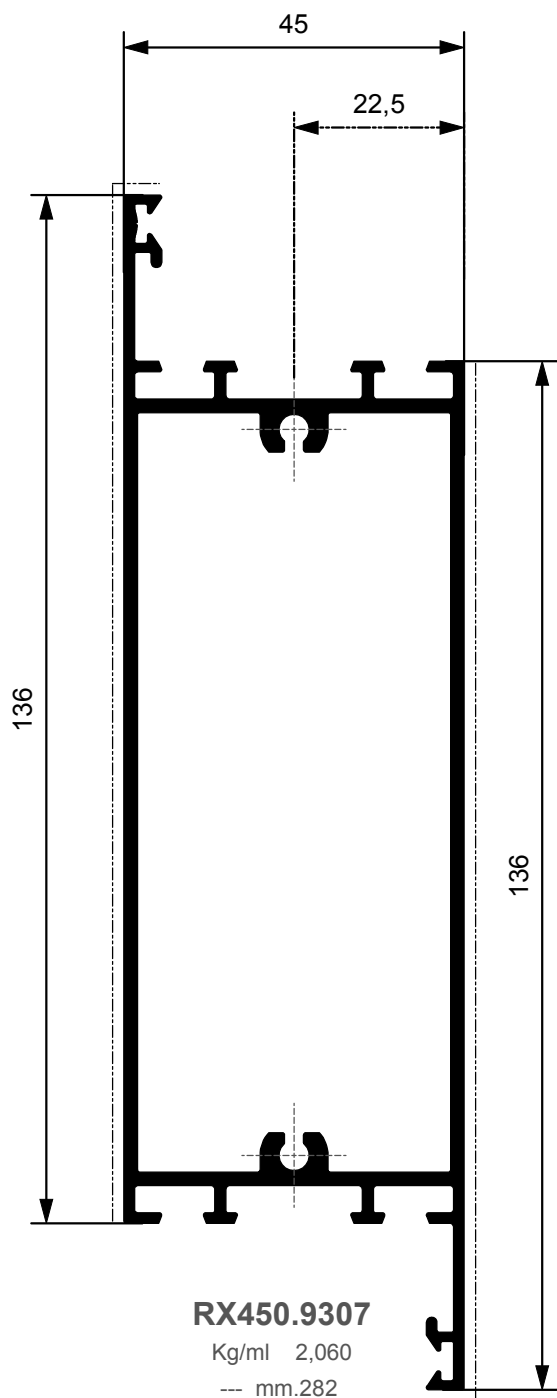

RX450.1009
Kg/ml 0,234
--- mm. 30

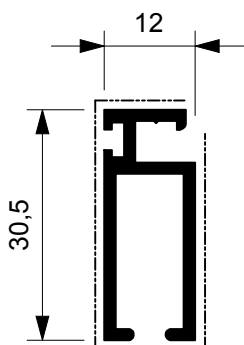

RX450.0099
Kg/ml 0,326
--- mm. 70



RX450.1342
Kg/ml 0,120
--- mm. 25

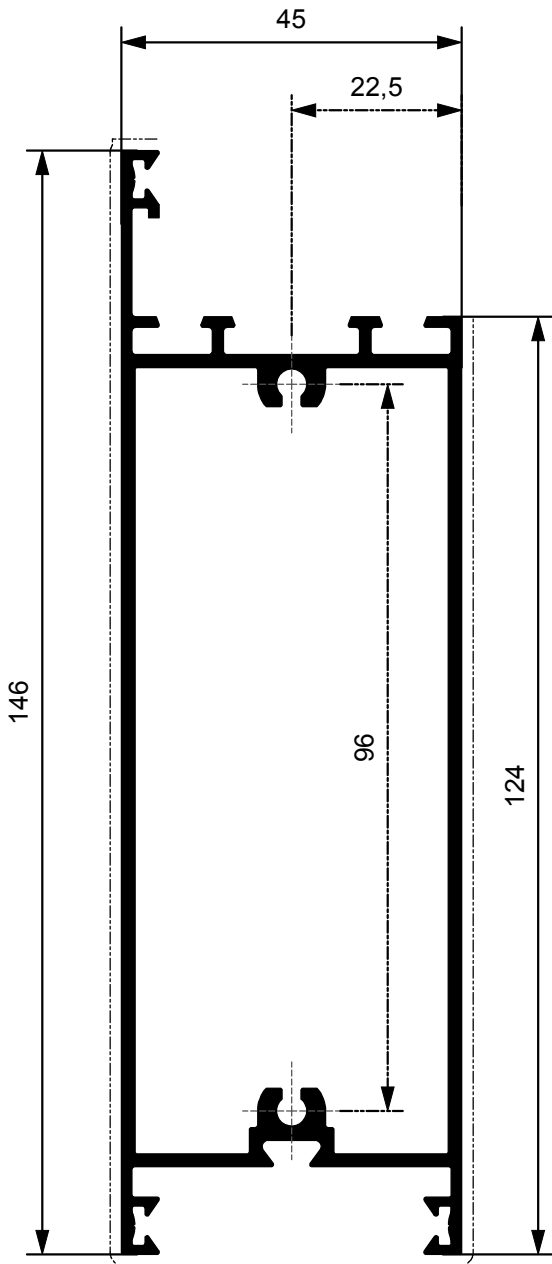

RX450.9261
Kg/ml 2,017
--- mm. 275

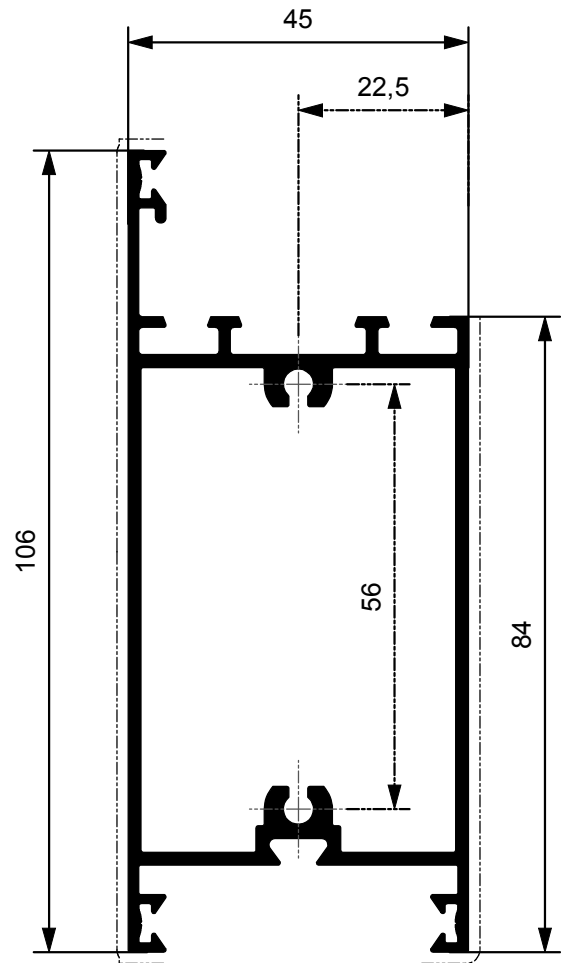

RX450.9262
Kg/ml 1,596
--- mm. 275

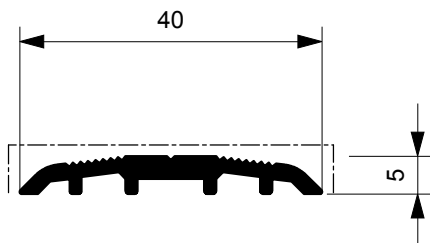

XX70.603
Kg/ml 0,275
--- mm. 40,0

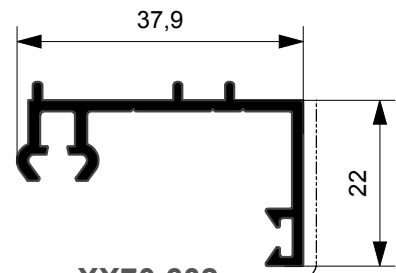

XX70.602
Kg/ml 0,372
--- mm. 22

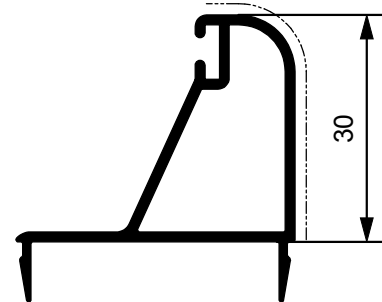
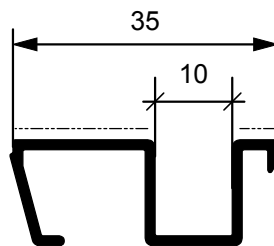
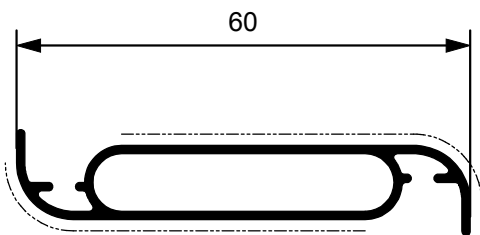
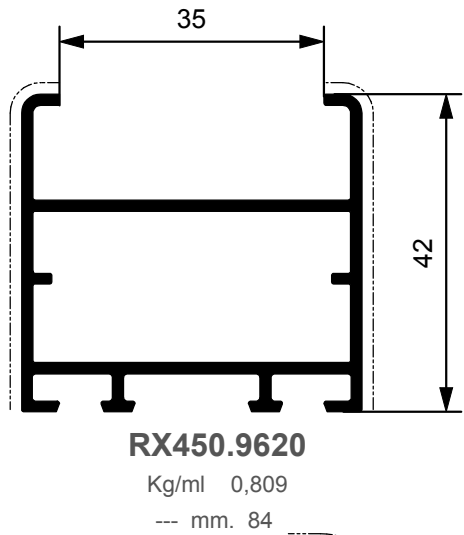
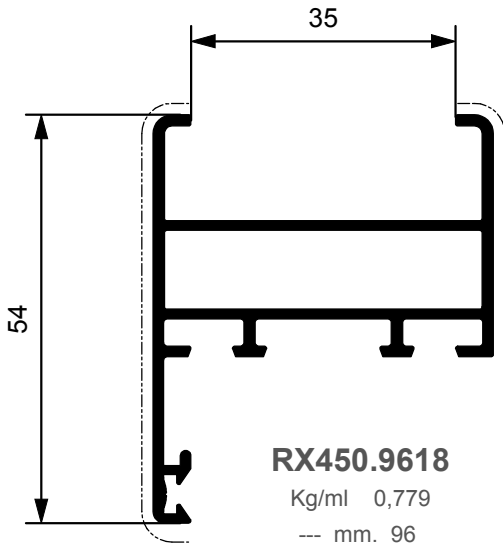
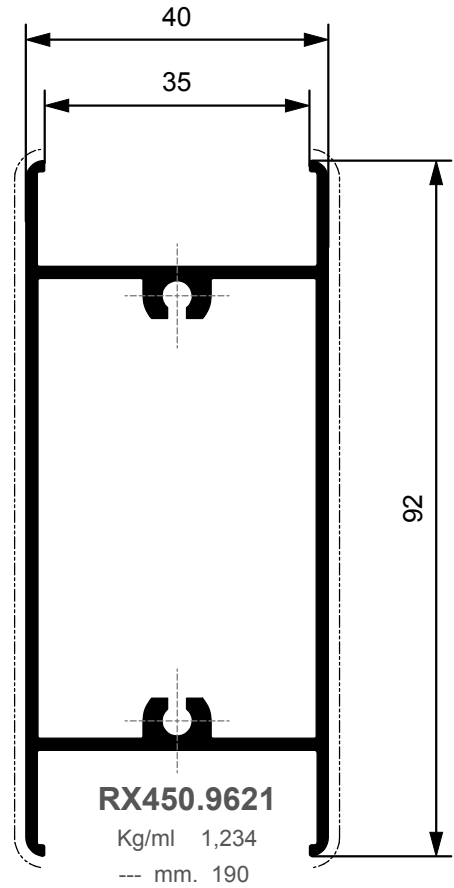
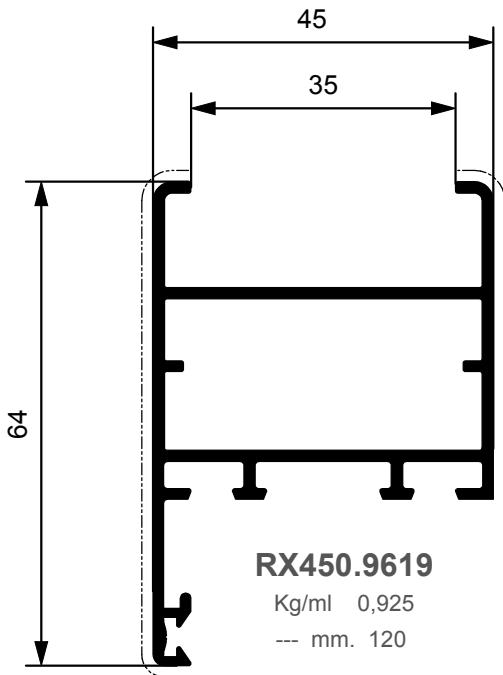

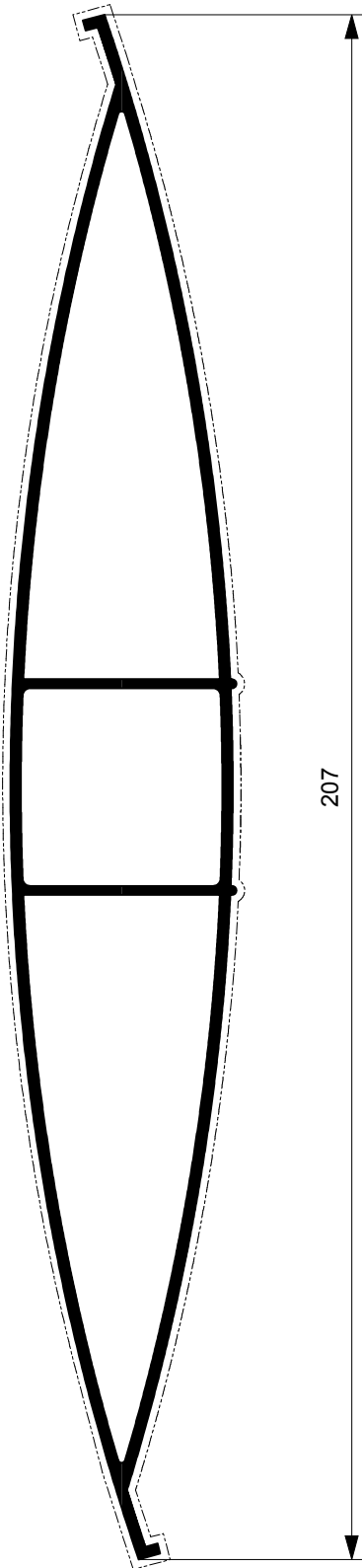

207

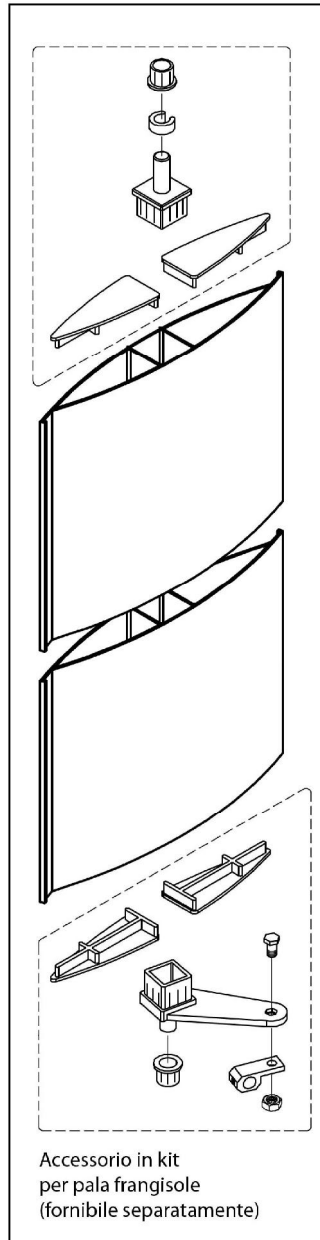

Accessorio in kit
per pala frangisole
(fornibile separatamente)

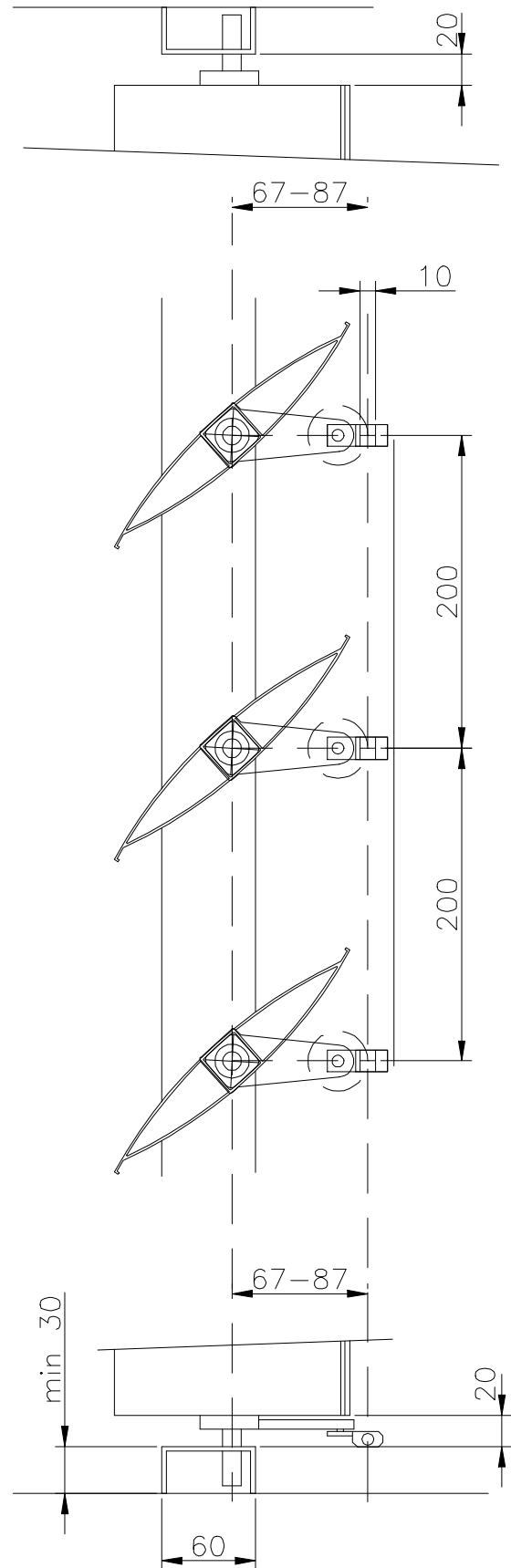

RX450.5247

Kg/ml 1,700

--- mm. 440

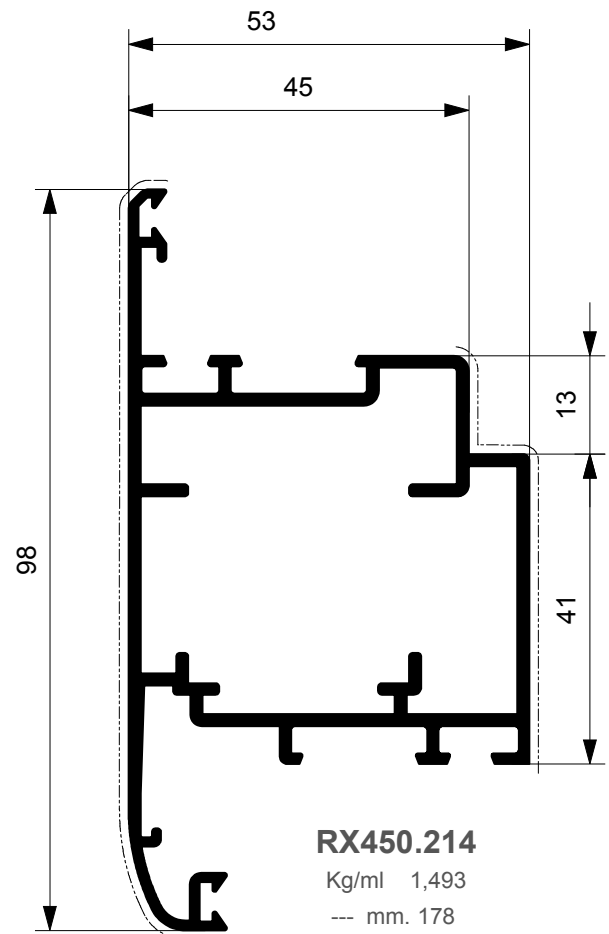
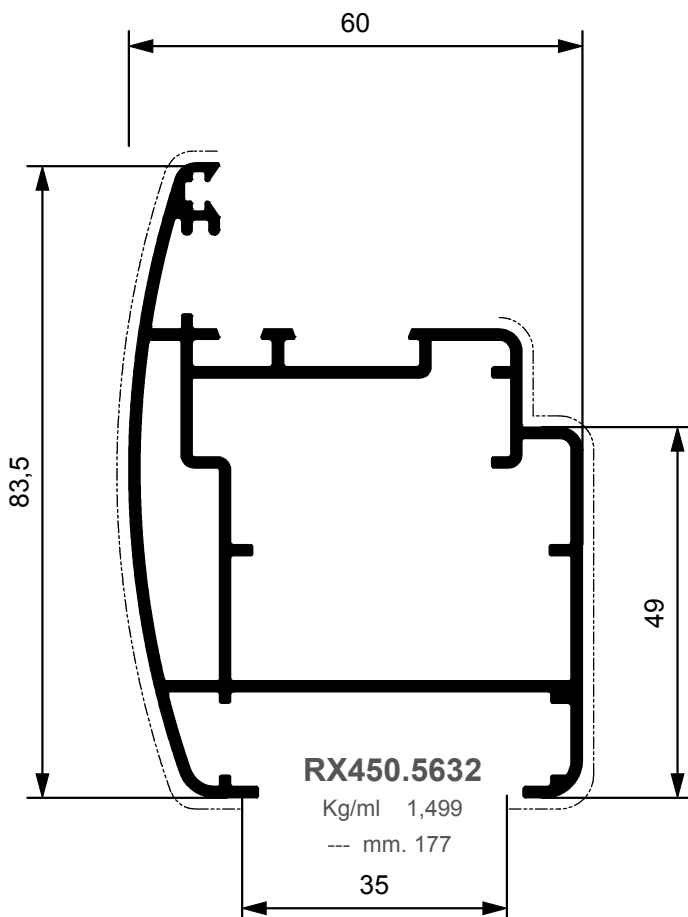
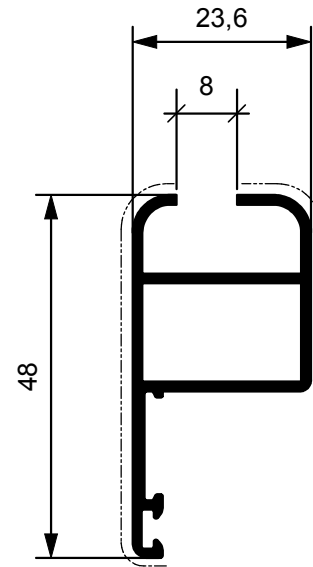
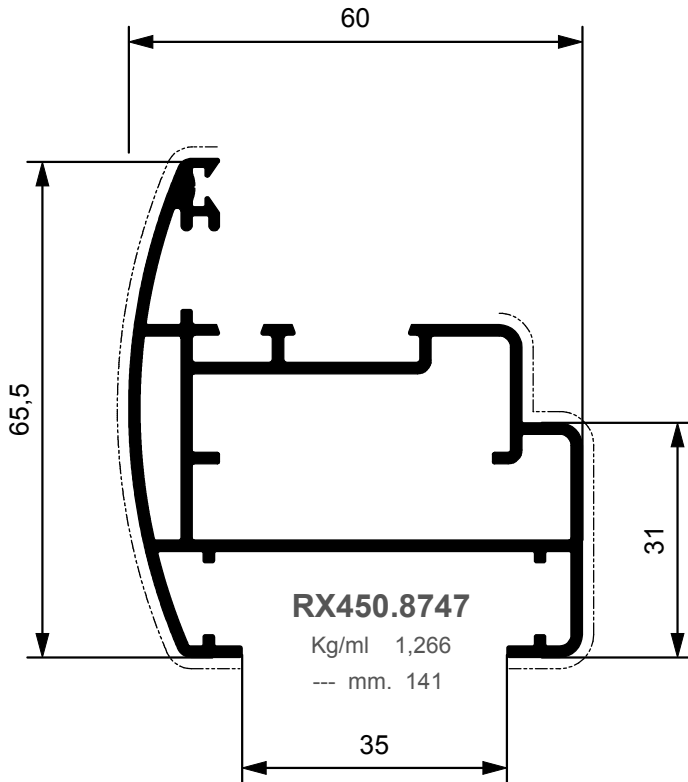

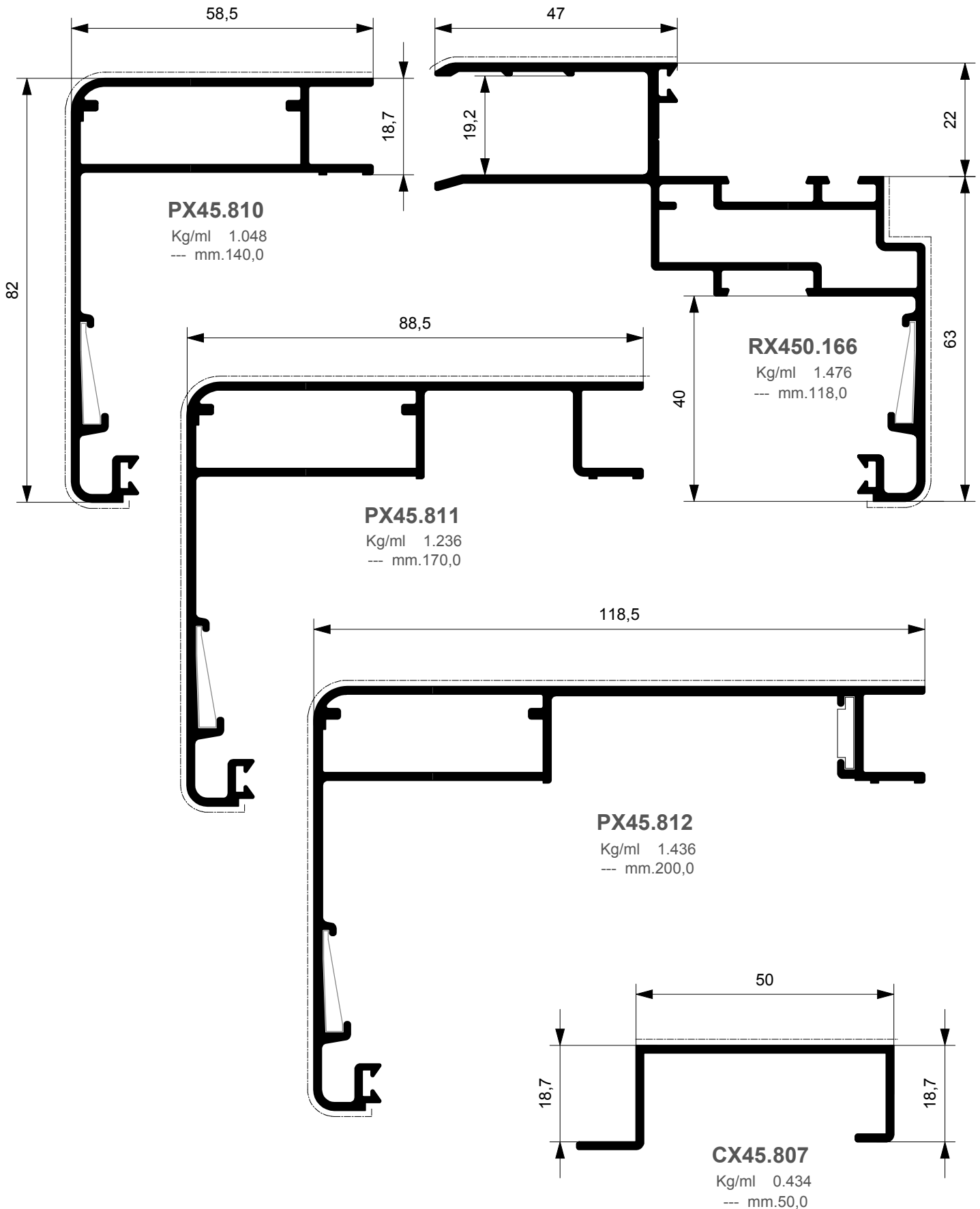



Schema dimensionale per opera muraria

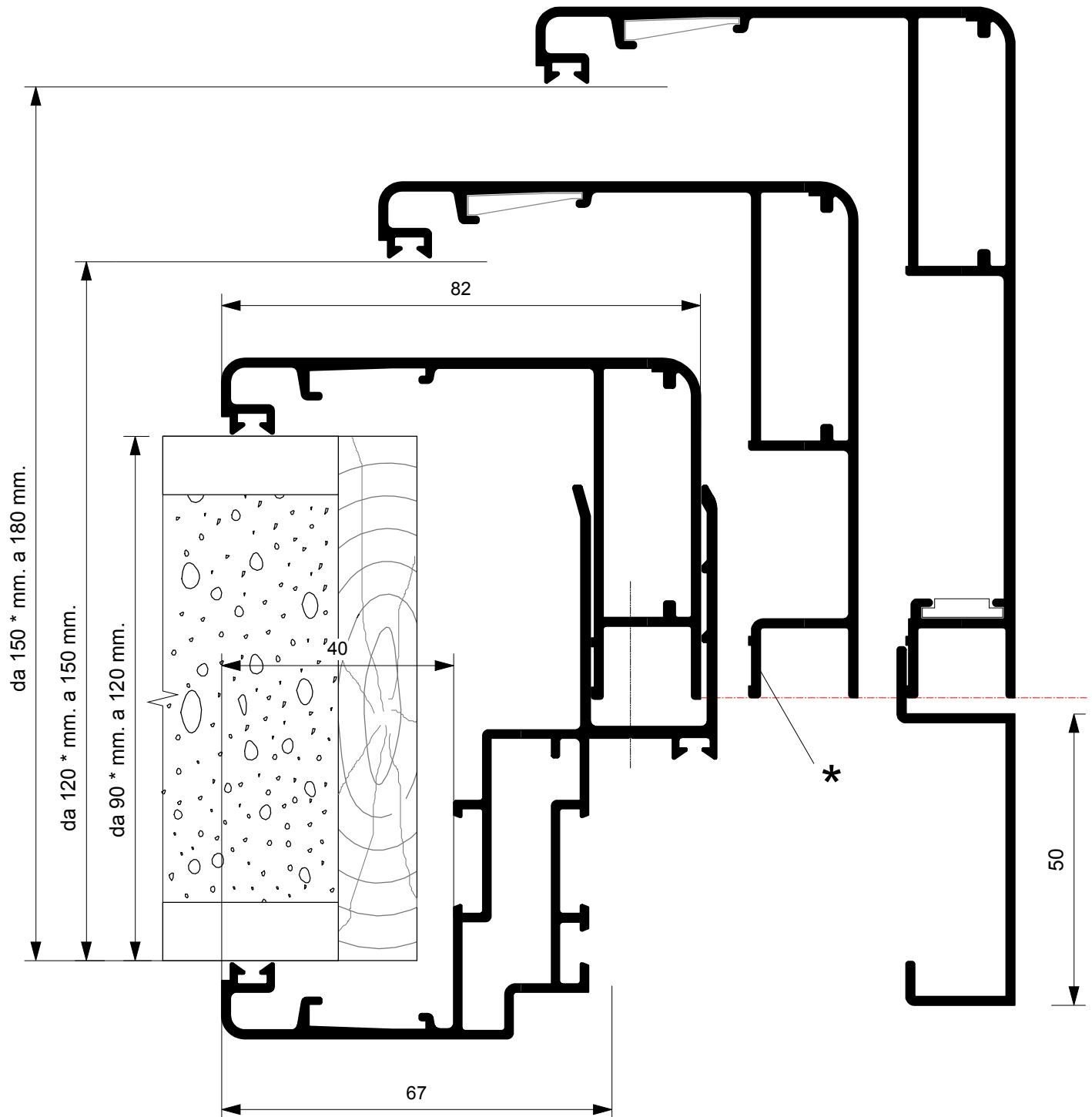

* Fresando le punte anche 10 mm. in meno

Utilizzando le guarnizioni di battuta telaio le dimensioni muro si riducono di mm.5

Utilizzando il profilo CX45.807 le dimensioni muro aumentano di mm.50 (multipli)

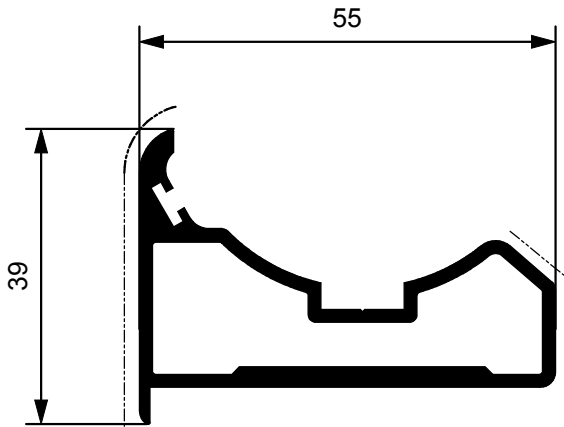
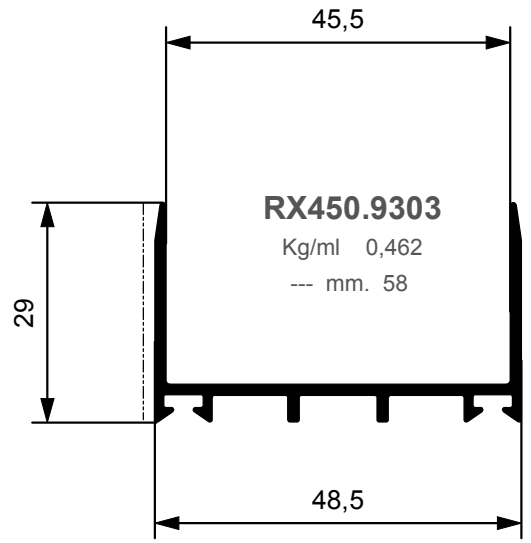
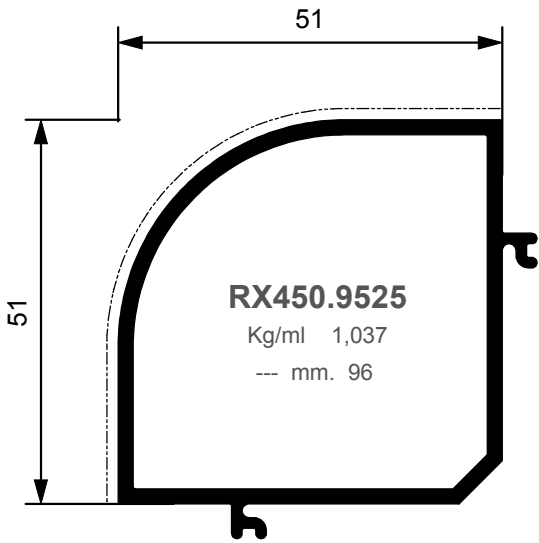

RX450.3570
Kg/ml 0,922
--- mm. 60

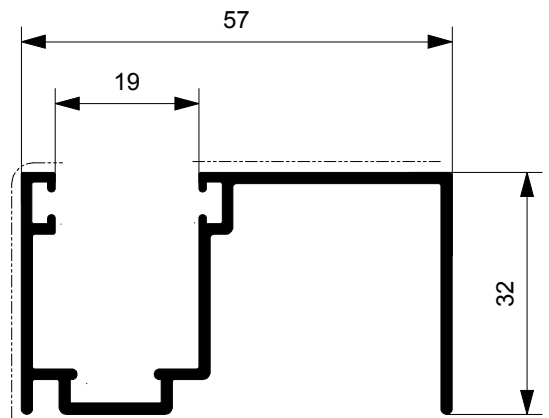

RX450.4595
Kg/ml 0,662
--- mm. 60

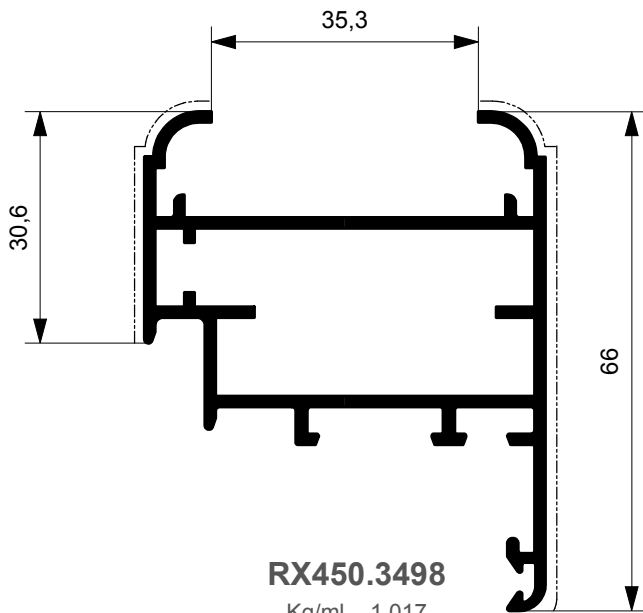

RX450.3498
Kg/ml 1,017
--- mm. 103

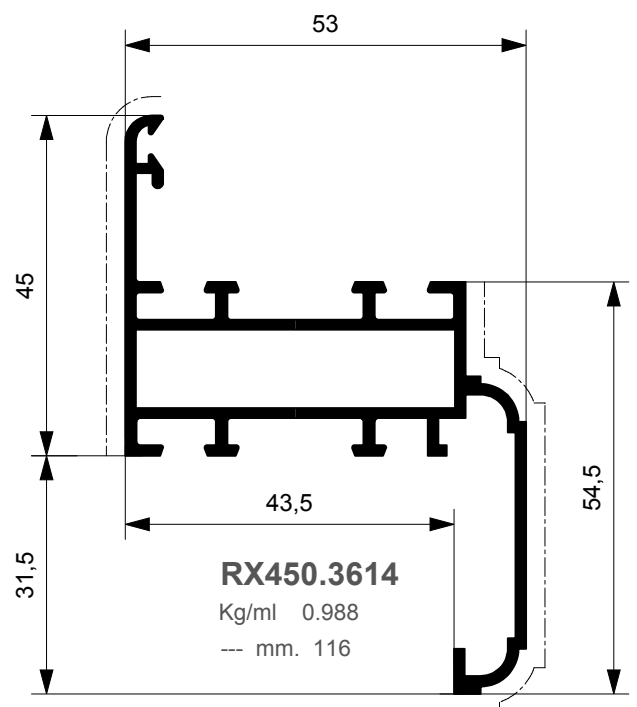

RX450.3614
Kg/ml 0,988
--- mm. 116

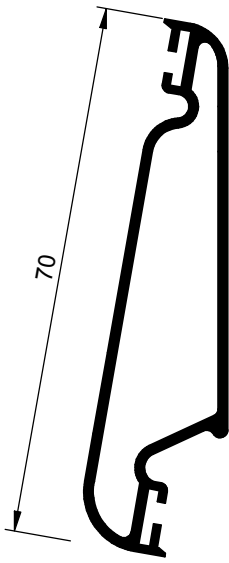

CX45.622

Kg/ml 0.530
--- mm. 160

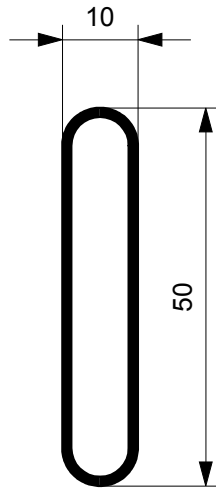

CX45.620

Kg/ml 0.364
--- mm. 111

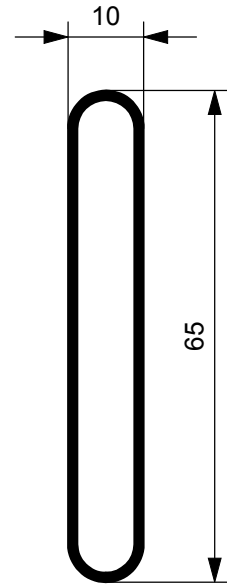

CX45.0933

Kg/ml 0.464
--- mm. 141

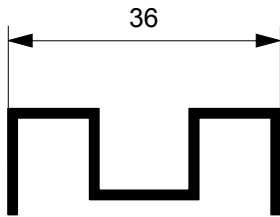

CX45.621

Kg/ml 0.308
--- mm. 24

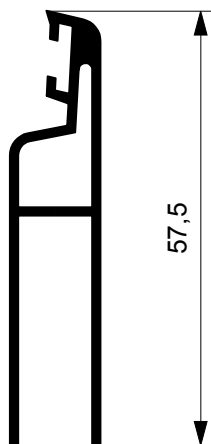

CX45.623

Kg/ml 0.448
--- mm. 104

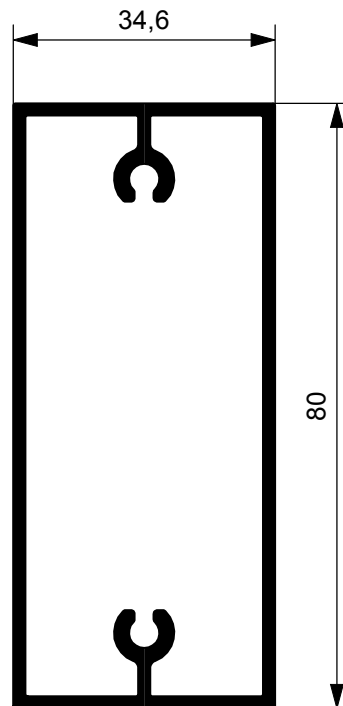

RX45.5220

Kg/ml 1.170
--- mm. 230

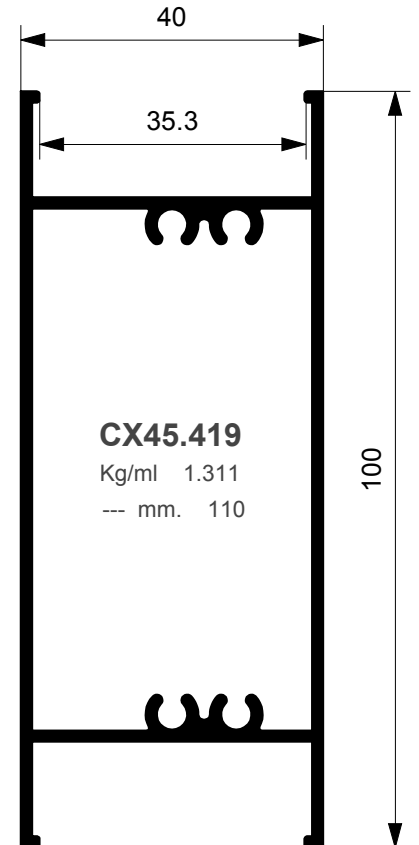

CX45.419

Kg/ml 1.311
--- mm. 110



Aletta (a) mm.	Vuoto (v) mm.	Dimensione fermavetro (f) mm.	Codice Fermavetro D = dritto T = tondo	Guarnizione esterna mm.	Guarnizioni interne vetro									
					ARX.10.15 mm.10 mm.9		ARX.10.14 mm.8 mm.7		ARX.10.13 mm.6 mm.5		ARX.10.12 mm.4 mm.3			
					Vetragezione (spessore vetro in mm.)									
5	10	30	D RX70.510 T RX70.505	3										4
5	14	26	D RX70.509 T RX70.504	3				4	5	6	7	8		
5	18	22	D RX70.508 T RX70.503	3	5	6	7	8	9	10	11	12		
5	22	18	D RX70.507 T RX70.502	3	9	10	11	12	13	14	15	16		
5	26	14	D RX70.506 T RX70.501	3	13	14	15	16	17	18	19	20		
5	30	10	D RX450.9431	3	17	18	19	20	21	22	23	24		
5	31	9	D RX450.8755	3	18	19	20	21	22	23	24	25		
5	35	5	D RX70.513	3	22	23	24	25	26	27	28	29		

NB. In caso di utilizzo della guarnizione ARX 10.28, sul lato esterno, aumentare spazio vetro di mm. 1,5

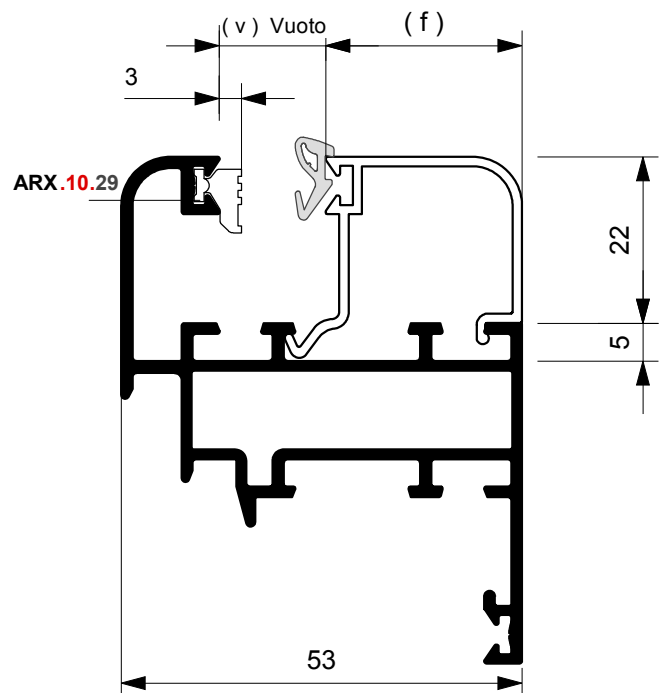
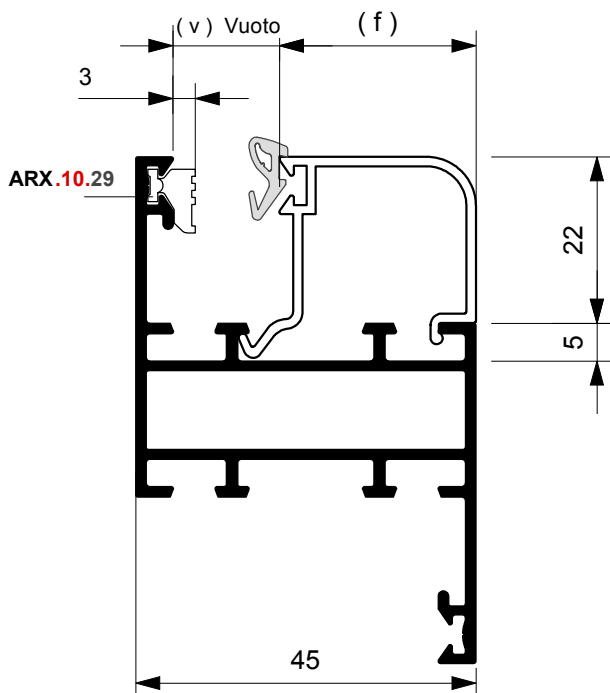

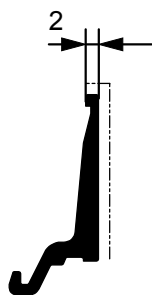

RX450.9186

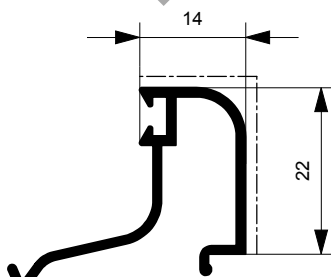

RX70.501

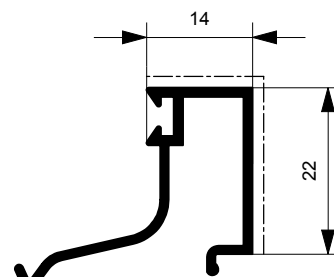

RX70.506

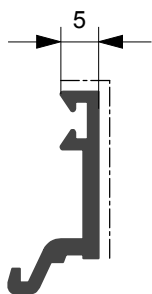

RX70.513

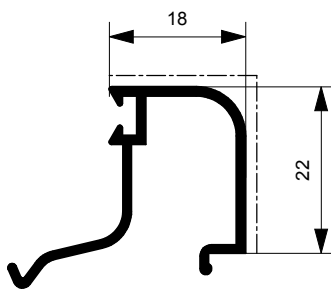

RX70.502

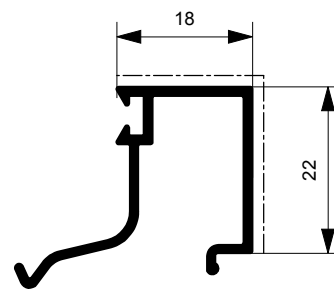

RX70.507

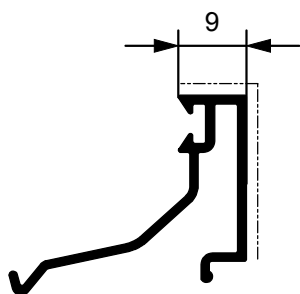

RX450.8755

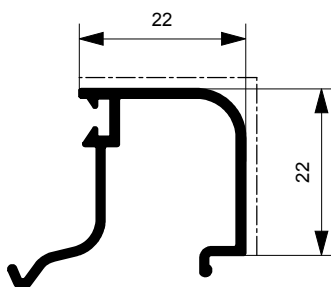

RX70.503

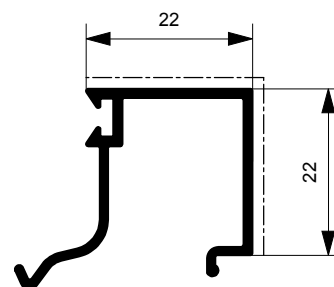

RX70.508

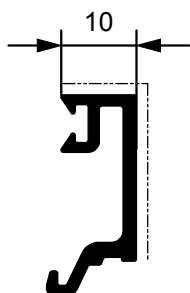

RX450.9431

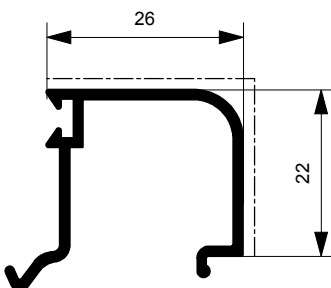

RX70.504

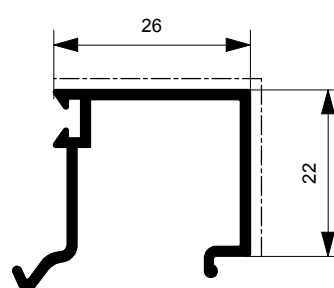

RX70.509

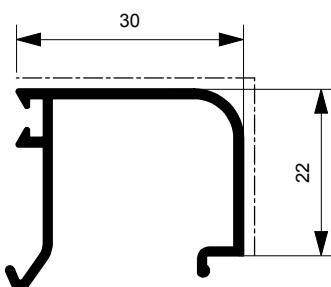

RX70.505

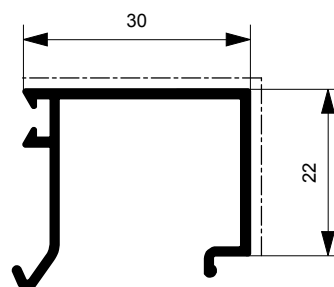

RX70.510



RX70.551

Kg/ml 0.280
--- mm. 36,0

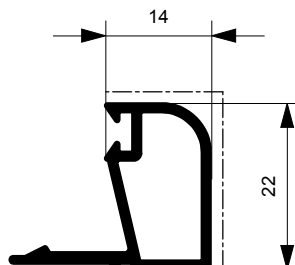

RX70.552

Kg/ml 0.297
--- mm. 40,0

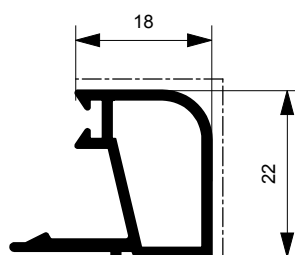

RX70.553

Kg/ml 0.308
--- mm. 44,0

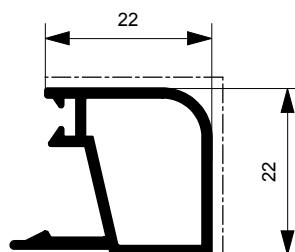

RX70.554

Kg/ml 0.332
--- mm. 48,0

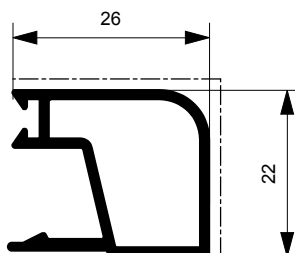

RX70.555

Kg/ml 0.350
--- mm. 52,0

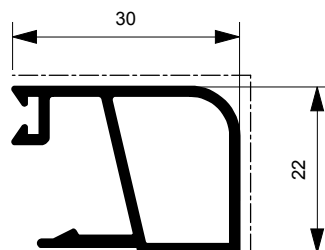

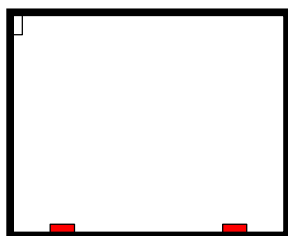

Telaio fisso

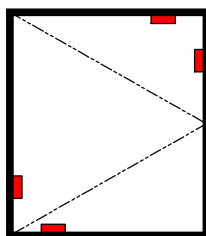

Anta a battente

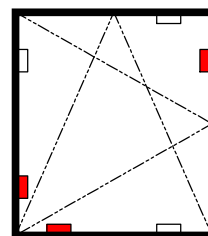

Anta ribalta

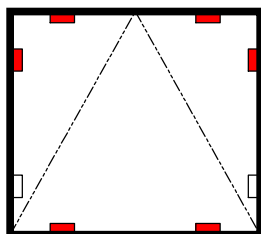

Wasistas

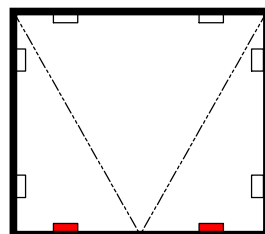

Sporgere

 Tassello d'appoggio

 Tassello periferico

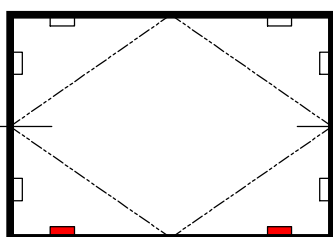

Bilico orizzontale

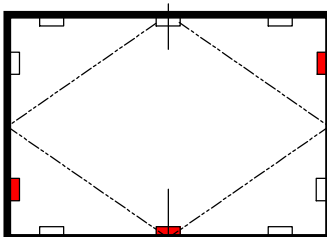

Bilico verticale

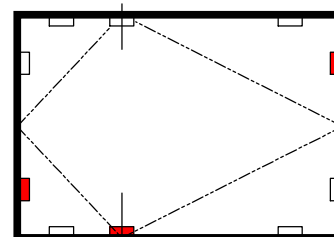

Bilico verticale (asse decentrato)

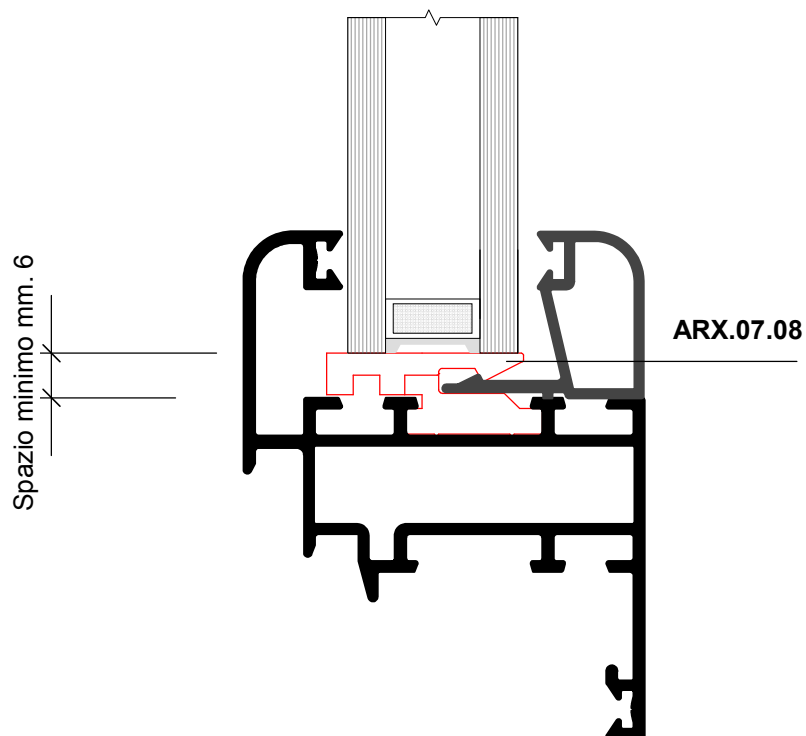

E' consigliabile l'abbinamento con fermavetri tradizionali con taglio a 45° ,al fine di evitare gli angoli/fermavetro in zama

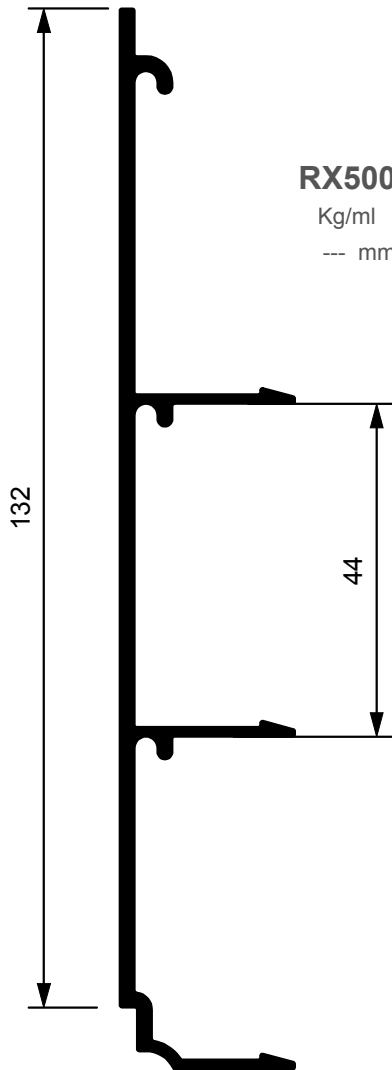

RX500.8772

Kg/ml 1,059
--- mm. 000

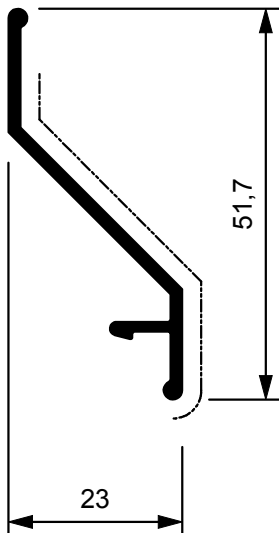

RX500.8771

Kg/ml 0,302
--- mm. 56

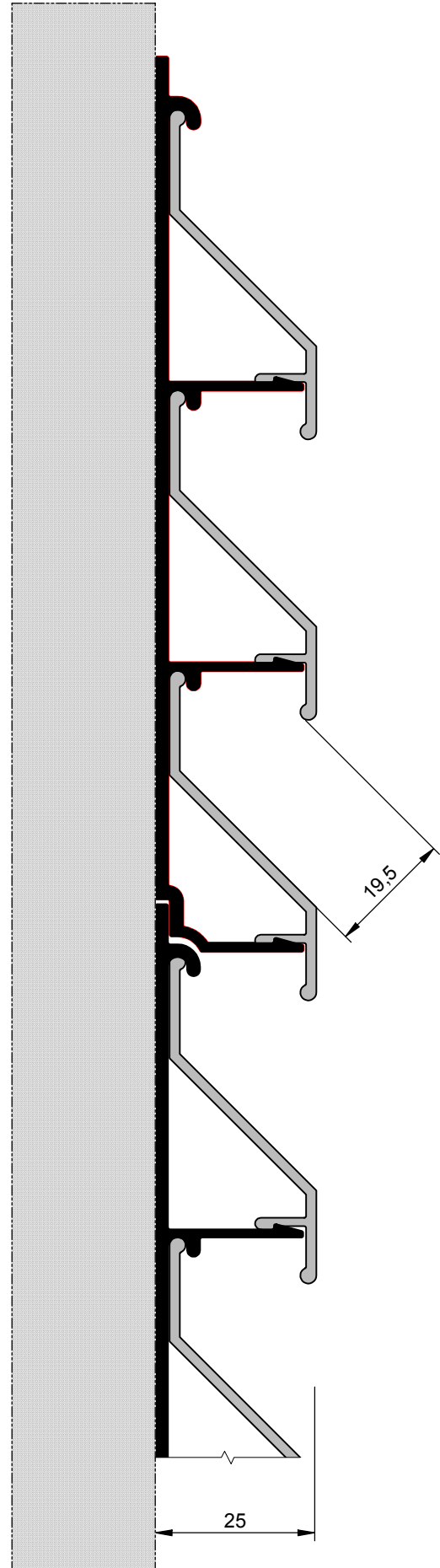



Linea **FG**

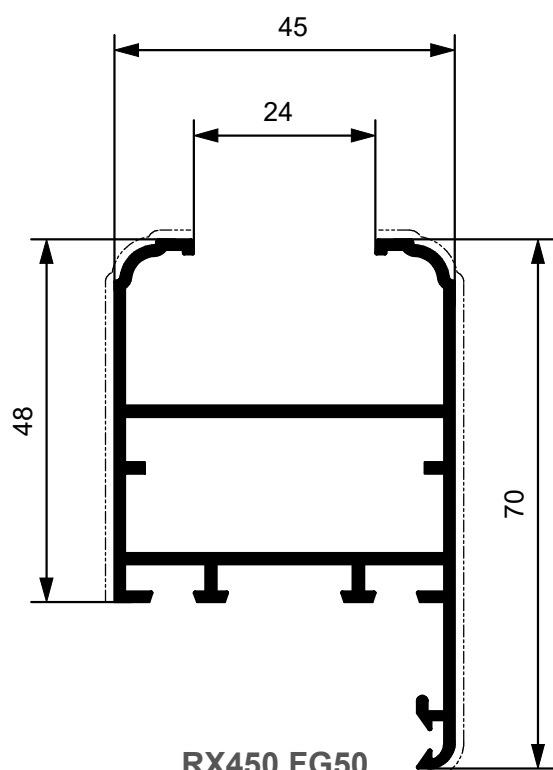

RX450.FG50
Kg/ml 0,946
--- mm. 135

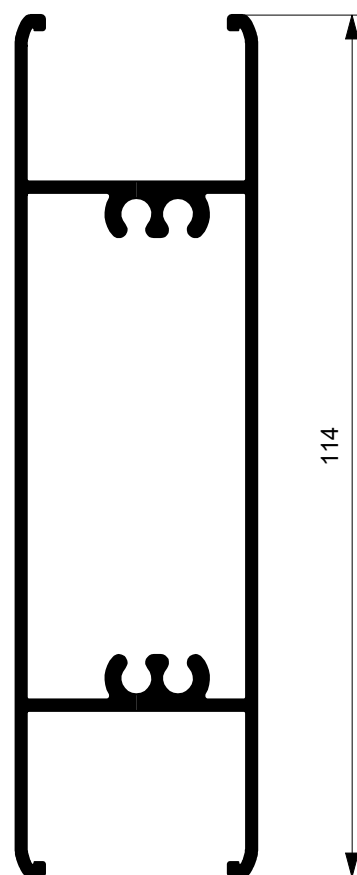

RX450.FG57
Kg/ml 1.416
--- mm. 234



Linea **FG**

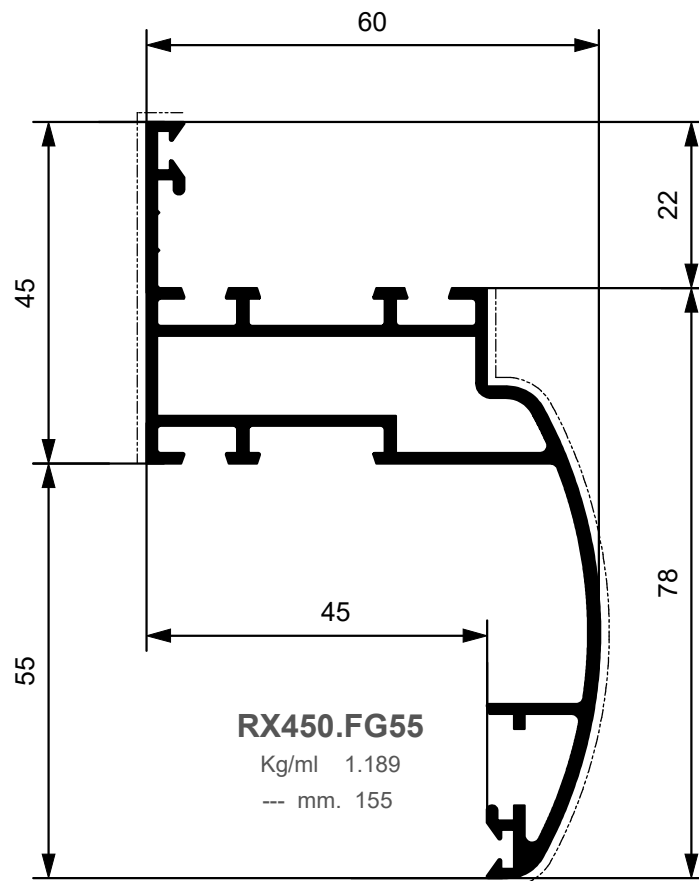
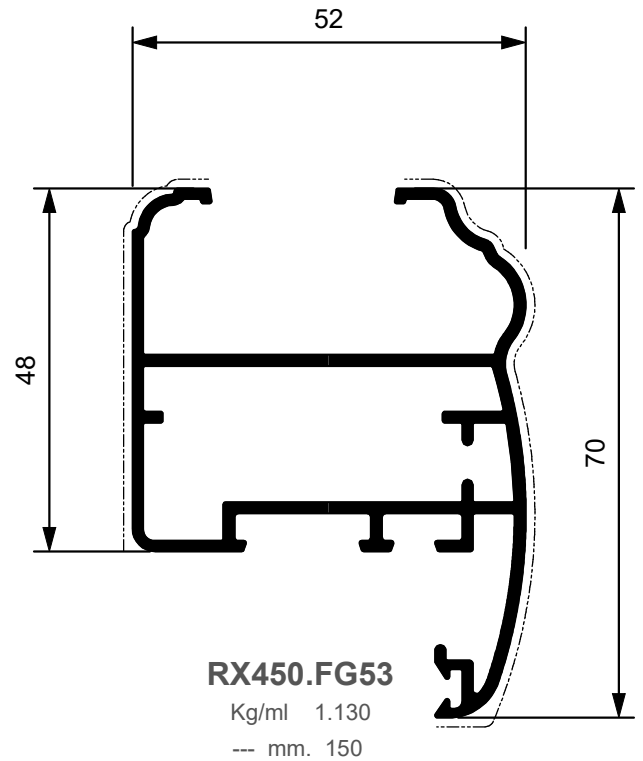
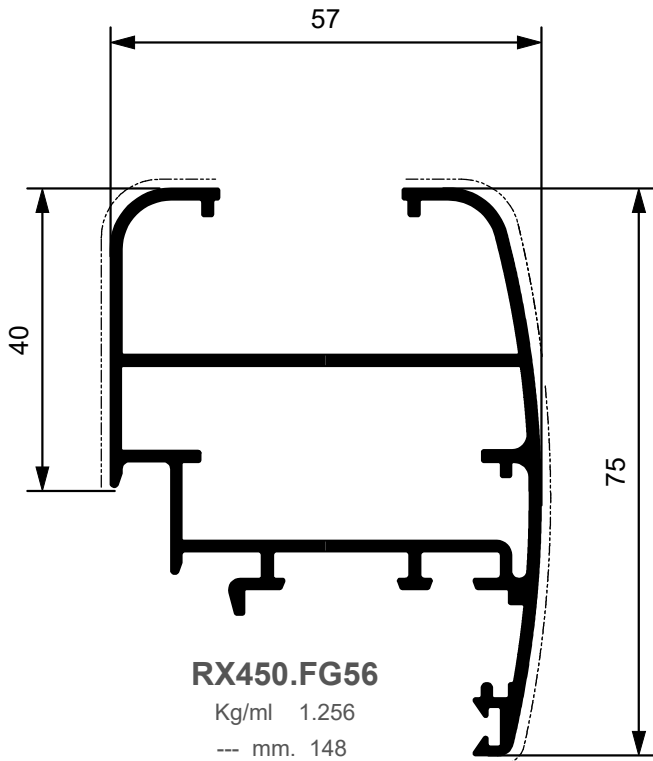

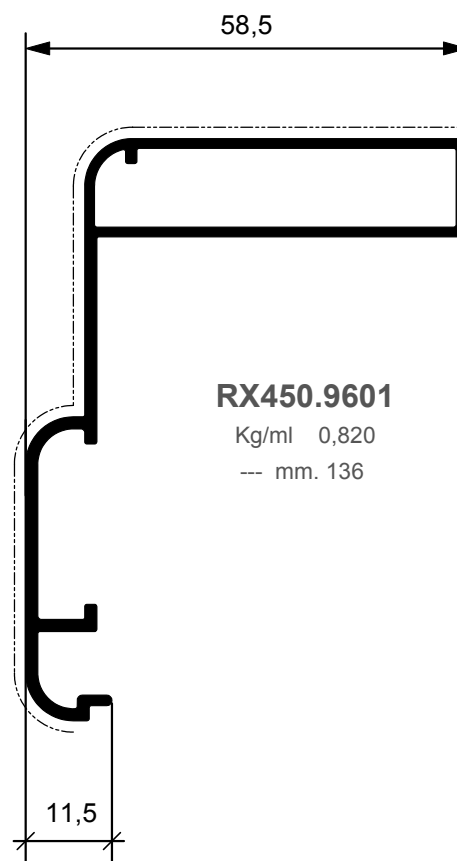
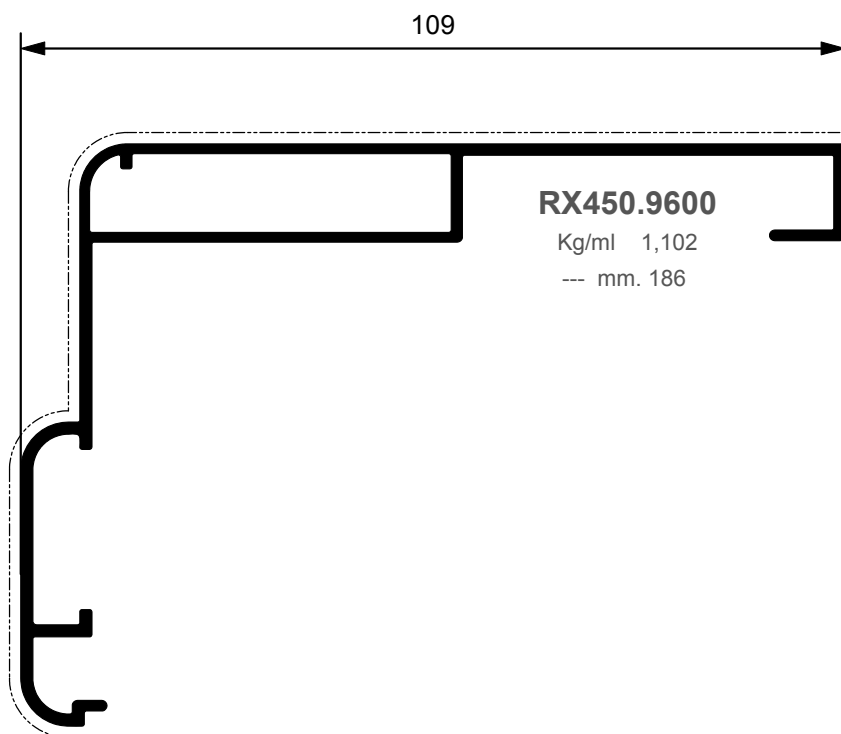
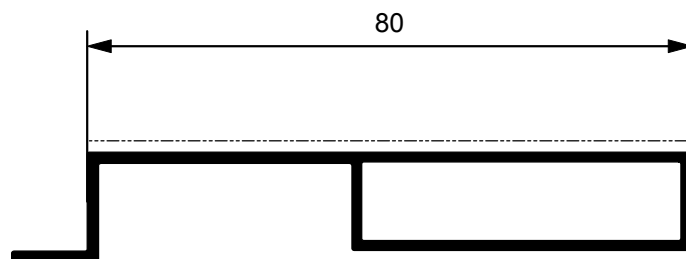
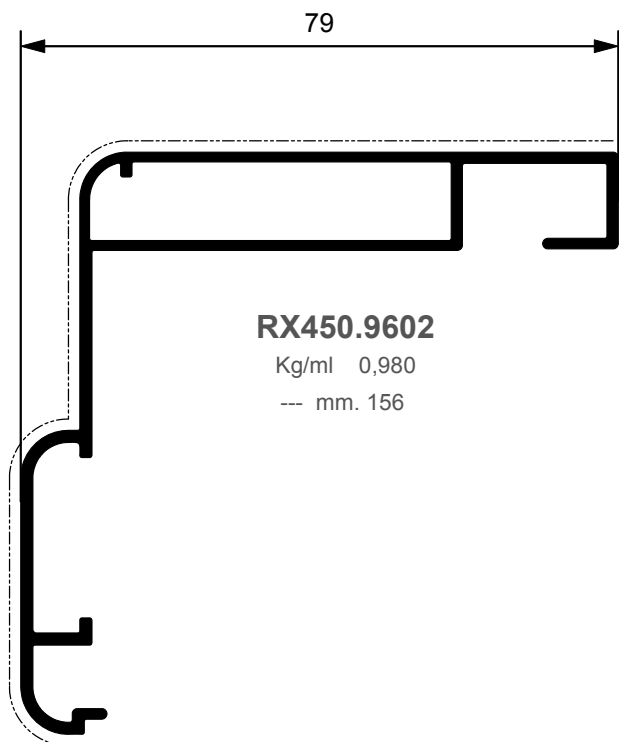

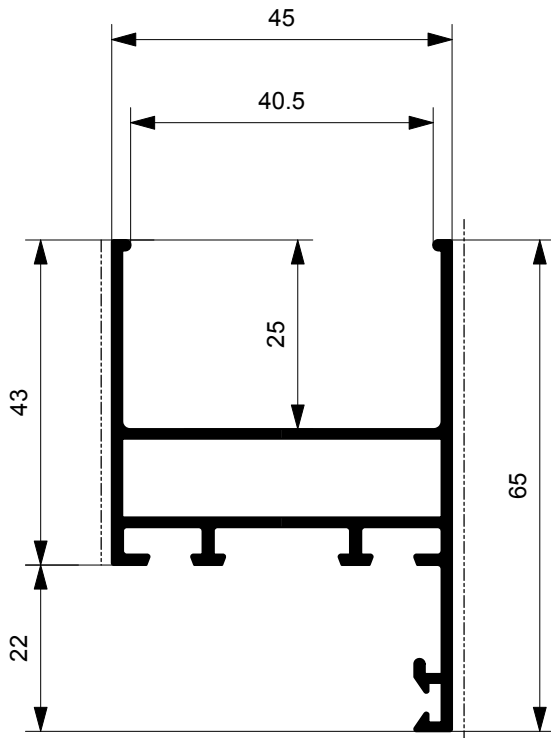

RX450.4544

Kg/ml 0,840

--- mm. 108

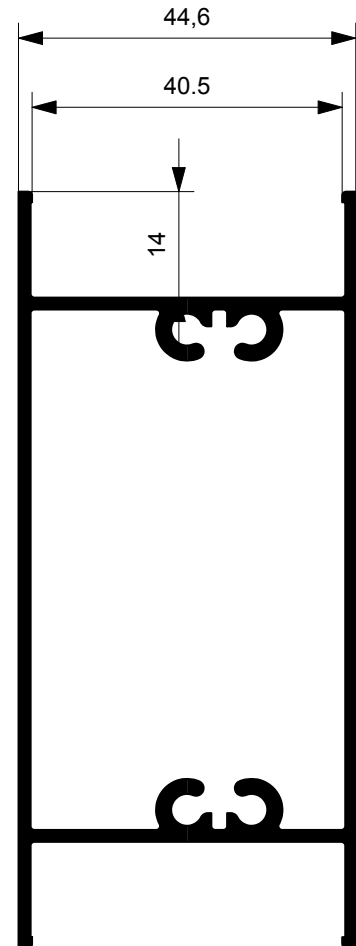

PX450.411

Kg/ml 1.428

--- mm.200,0



Squadrette

<p>ARX.10.SQ</p> <p>Descrizione Squadretta allineamento interna</p> <p>Materiale Nylon</p>		<p>ARX.42.SQ</p> <p>Giunto in alluminio</p> <p>Materiale Alluminio</p>	
<p>ARX.26.SQ</p> <p>Descrizione Squadretta a bottone <i>(40.8 mm x 9.9 m)</i></p> <p>Materiale Zama</p>			
<p>ARX.34.SQ</p> <p>Descrizione Squadretta a bottone profilo scuretto RX450.0427</p> <p>Materiale Zama</p>			
<p>ARX.37.SQ</p> <p>Descrizione Squadretta allineamento esterna per prof. complanari</p> <p>Materiale Nylon</p>			
<p>ARX.38.SQ</p> <p>Descrizione Squadretta allineamento su aletta prof. RX450.8427</p> <p>Materiale Acciaio</p>			
<p>ARX.39.SQ</p> <p>Descrizione Squadretta in alluminio estruso con inserto unificato</p> <p>Materiale Alluminio</p>			
<p>ARX.40.SQ</p> <p>Descrizione Squadretta in alluminio estruso prof. R450.9227-9228-9229</p> <p>Materiale Alluminio</p>			
<p>ARX.41.SQ</p> <p>Descrizione Squadretta in alluminio estruso prof. R450.8535</p> <p>Materiale Alluminio</p>			



Cerniere

ARX.02.01	
Descrizione Cerniera a montaggio rapido preassemblata a 2 ali	
Materiale Alluminio - Acciaio inox	

ARX.02.02	
Descrizione Cerniera a montaggio rapido preassemblata a 2 ali per 3°anta	
Materiale Alluminio - Acciaio inox	

ARX.02.03	
Descrizione Cerniera a montaggio rapido preassemblata a 3 ali	
Materiale Alluminio - Acciaio inox	

ARX.02.04	
Descrizione Cerniera a montaggio rapido preassemblata a 3 ali per 3°anta	
Materiale Alluminio - Acciaio inox	

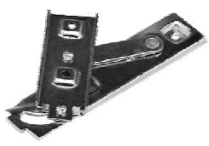
ARX.02.05	
Descrizione Cerniera per vasistas apertura singola 30°	
Materiale Acciaio	

ARX.02.06	
Descrizione Cerniera per vasistas apertura doppia 30°/75°	
Materiale Acciaio	

ARX.02.07	
Descrizione Braccio lungo per vasistas (anta da mm. 600 a mm. 1600)	
Materiale Acciaio	

ARX.02.08	
Descrizione Braccio corto per vasistas (anta da mm. 280 a mm. 800)	
Materiale Acciaio	

Cerniere

ARX.02.09	
Descrizione Braccio telescopico per vasistas a scatto	
Materiale Acciaio	

ARX.02.10	
Descrizione Cerniera a compasso	
Materiale Acciaio	

ARX.02.11	
Descrizione Cerniera a 2 ali per porte con piastrina ad infilare	
Materiale Alluminio-Acciaio inox	

ARX.02.12	
Descrizione Cerniera per porte esterna a 2 ali interasse 67 mm.	
Materiale Alluminio-Acciaio inox	

ARX.02.13	
Descrizione Cerniera per porte esterna a 3 ali interasse 67 mm.	
Materiale Alluminio-Acciaio inox	

ARX.02.16	
Descrizione Spessore mm.8 per cerniere esterne per porte	
Materiale Alluminio-Acciaio inox	

ARX.02.17	
Descrizione Cerniera per scuretto	
Materiale Alluminio-Acciaio inox	

ARX.02.24	
Descrizione Viti di fissaggio cerniere	
Materiale Acciaio	



Cerniere

Chiusure

ARX.02.26	
Cerniera a 2 ali per porte con piastrina ad infilare 3 anta	
Materiale Alluminio-Acciaio inox	

ARX.03.01	
Descrizione Cricchetto in alluminio fissaggio con piastrine	
Materiale Zama - Acciaio	

ARX.02.27	
Cerniera a 3 ali per porte con piastrina ad infilare	
Materiale Alluminio-Acciaio inox	

ARX.03.02	
Descrizione Maniglia a tavellino	
Materiale Zama	

ARX.02.31	
Descrizione Kit contropiastre cerniere a 2 ali	
Materiale Alluminio	

ARX.03.03	
Descrizione Maniglia doppia	
Materiale Zama	

ARX.02.32	
Descrizione Kit contropiastre cerniere a 3 ali	
Materiale Alluminio	

ARX.03.04	
Descrizione Martellina Sporgenza quadro mm.24	
Materiale Zama	

ARX.02.33	
Descrizione Cerniera per porte esterna a 2 ali interasse 79 mm.	
Materiale Alluminio-Acciaio inox	

ARX.03.05	
Descrizione Martellina con chiave Sporgenza quadro mm.24	
Materiale Zama	

ARX.02.34	
Descrizione Cerniera per porte esterna a 3 ali interasse 79 mm.	
Materiale Alluminio-Acciaio inox	

ARX.03.06	
Descrizione Cremonese Interasse 84 - 92 - 104	
Materiale Zama	

ARX.02.28	
Cerniera a 3 ali per porte con piastrina ad infilare 3 anta	
Materiale Alluminio-Acciaio inox	

ARX.03.07	
Descrizione Cremonese con chiave Interasse 84 - 92 - 104	
Materiale Zama	

ARX.02.30	
Cerniera sfilabile con contropiastra e collo lungo	
Alluminio-Acciaio inox	

ARX.03.08	
Descrizione Cremonese per Anta Ribalta	
Materiale Zama	



Chiusure

ARX.03.09	
Descrizione	
Movimentazione Bidirezionale	
Materiale	Zama

ARX.03.10	
Descrizione	
Movimentazione Unidirezionale per Anta Ribalta	
Materiale	Zama

ARX.03.11	
Descrizione	
Catenacciolo a leva	
Materiale	Zama

ARX.03.12	
Descrizione	
Terminale asta	
Materiale	Zama

ARX.03.13	
Descrizione	
Incontro asta doppio	
Materiale	Zama

ARX.03.14	
Descrizione	
Ferma anta	
Materiale	Zama

Chiusure

ARX.03.15	
Descrizione	
Perno di chiusura supplementare regolabile	
Materiale	Zama

ARX.03.16	
Descrizione	
Innesti cremonese	
Materiale	Nylon

ARX.03.17	
Descrizione	
Terminali astina	
Materiale	Nylon

ARX.03.18	
Descrizione	
Maniglia aperture esterne (maniglia + cursore)	
Materiale	Metallo pressofuso

ARX.03.19	
Descrizione	
Maniglia a tavellino per sporgere e bilico	
Materiale	Metallo estruso e nylon

ARX.03.20	
Descrizione	
Gruppo articolazione per sporgere rinforzato completo di bracci ,portata 90 kg. L = mm300	
Materiale	Metallo estruso e nylon

ARX.03.21	
Descrizione	
Incontro 3° chiusura su innesti cremonese	
Materiale	Nylon



Chiusure

ARX.03.22	
Descrizione	
ARX.03.23	
Descrizione	
ARX.03.24	
Descrizione	

ARX.03.25	
Descrizione	
Kit Fast Out chiusura apert. esterna art. ARX.03.22	
ARX.03.26	
Kit Fast Out chiusura apert. esterna art. ARX.03.23	
ARX.03.27	
Kit Fast Out chiusura apert. esterna art. ARX.03.24	

ARX.03.28	
Martellina Sporgenza quadro mm.64 per Fast Out	

ARX.03.29	
Riscontro Hook lato cerniera	

ARX.03.30	
Maniglia a tavellino manico piccolo	

Chiusure

ARX.03.31	
Kit bilico orizzontale a chiusure multiple Confezione completa con cremonese pressofusa Portata max: 90kg/kit	

ARX.03.32	
Kit bilico verticale a chiusure multiple Confezione completa con cremonese pressofusa Cuscinetto reggispinta Portata max: 90kg/kit	

ARX.03.33	
Cremonese VELA per apertura esterna Interasse 104-108 mm.	
Materiale	
Metallo pressofuso	

ARX.03.34	
Chiusura a cricchetto regolabile per wasistas	
Materiale	
Metallo pressofuso	

ARX.03.35	
Manovra per puntali in abbinamento RX450.9221	
Materiale	

ARX.03.36	
Serratura con cilindro in zama con perno in acciaio inox	
Materiale	



Chiusure

29.5.001	
Chiusura per scuretto	
Materiale	

ARX.03.37	
Innesti guida apertura esterna	
Materiale Alluminio	

ARX.03.38	
Innesti guida apertura esterna profili maggiorati	
Materiale Alluminio	

ARX.03.39	
Innesti guida apertura esterna su profilo tipo RX450.9264	
Materiale Alluminio	

ARX.03.40	
Innesti guida apertura esterna su profilo tipo RX450.5632	
Materiale Alluminio	

ARX.03.41	
Sostegno anta con rullino	
Materiale Zama	

ARX.03.43	
Astina in poliammide	

ARX.03.44	
Perno trascinamento L=16 mm.	

Chiusure

ARX.03.45	
Perno trascinamento L=22 mm.	

Tappi

ARX.04.30	
Descrizione Tappo a L battuta inferiore porte	
Materiale Dutral	

ARX.04.31	
Descrizione Tappo diritto battuta inf. porte	
Materiale Dutral	

ARX.04.35	
Descrizione Coppia tappi su riporto centrale RX450.9658	
Materiale Dutral	

ARX.04.36	
Descrizione Coppia tappi su riporto centrale RX450.8695	
Materiale Dutral	

Scarichi acqua

ARX.05.01	
Descrizione Cappetta drenaggio acqua	
Materiale Nylon	

509.260.55	nero	
Descrizione Cappetta drenaggio acqua in nylon		
509.260.60	bianco	

509.261.55	nero	
Descrizione Cappetta drenaggio acqua in nylon		
509.262.55	bianco	



Accessori vetro

418.110.55	
Descrizione Supporto lamella persiana fissa su profilo RX450.9392	
Materiale Nylon	

ARX.07.01	
Descrizione Registro vetrocamera per profili vetro ad infilare	
Materiale Nylon	

Attacchi muratura

ARX.06.01	
Descrizione Registro Universale	
Materiale Nylon	

ARX.07.02	
Descrizione Angolo Universale fermavetro	
Materiale Zama	

ARX.06.02	
Descrizione Piastrina Registro Universale	
Materiale Zama	

ARX.07.08	
Descrizione Clip per fermavetri tondi	
Materiale Nylon	

ACX.06.04	
Descrizione Registro Z/P	
Materiale Nylon	

Anta ribalta

ARX.08.01	
Descrizione Anta Ribalta Kit BASE senza cremonese con anti falsa manovra sulla cremonese	
Materiale Fulcro verticale	

ARX.06.07	
Descrizione Basetta unificata per regolo mobile	
Materiale Zama	

ARX.06.08	
Descrizione Regolo mobile da mm. 15	
Materiale Alluminio	

ARX.08.05	
Descrizione A. R. Braccio Supplementare	
Materiale	

ARX.06.09	
Descrizione Regolo mobile da mm. 20	
Materiale Alluminio	

ARX.08.06	
Descrizione Chiusura Supplementare verticale	
Materiale	

ARX.06.10	
Descrizione Regolo mobile da mm. 30	
Materiale Alluminio	

ARX.08.09	
Descrizione A. R. Cerniere a pettine	
Materiale	

ARX.06.11	
Descrizione Regolo mobile da mm. 45	
Materiale Alluminio	



Anta ribalta

ARX.08.10	
Descrizione	
<p>Anta Ribalta Kit BASE senza cremonese con anti falsa manovra sulla cremonese</p> <p>Fulcro orizzontale</p>	
Materiale	

ARX.08.12	
Descrizione	
<p>Riscontro per anta affiancata</p>	
Materiale	

ARX.08.14	
Descrizione	
<p>Chiusura Supplementare orizzontale</p>	
Materiale	

ARX.08.15	
Descrizione	
<p>A. R. Cerniere a pettine portata Kg. 120</p>	
Materiale	

ARX.08.16	
Descrizione	
<p>Perno chiusura supplementare</p>	
Materiale	

ARX.08.17	
Descrizione	
<p>Kit sostegno anta</p>	
Materiale	

ARX.08.18	
Descrizione	
<p>Chiusura supplementare inferiore orizzontale</p>	
Materiale	

Anta ribalta

ARX.08.19	
Descrizione	
<p>Dispositivo microventilazione</p>	
Materiale	

ARX.08.20	
Descrizione	
<p>Anta Ribalta Kit BASE senza cremonese con anti falsa manovra sulla cremonese</p> <p>Portata 120 Kg.</p>	
Materiale	

ARX.08.22	
Descrizione	
<p>Anta Ribalta Braccio Corto Portata 120 Kg.</p>	
Materiale	

ARX.08.23	
Descrizione	
<p>Anta Ribalta Braccio Medio Portata 120 Kg.</p>	
Materiale	

ARX.08.24	
Descrizione	
<p>Anta Ribalta Braccio Lungo Portata 120 Kg.</p>	
Materiale	

ARX.08.25	
Descrizione	
<p>Kit cerniera a pettine regol. Portata 120 Kg.</p>	
Materiale	



Guarnizioni

Guarnizioni

ARX.10.03	
Descrizione Guarnizione di battuta a scatto	

ARX.10.29	
Descrizione Guarnizione vetro esterna coestrusa spessore 3 mm.	

ARX.10.04	
Descrizione Guarnizione di battuta ad infilo	

ASX.10.35	
Descrizione Guarnizione PVC per porte	

ARX.10.07	
Descrizione Guarnizione di battuta esterna acustica esterna mm.1	

ARX.10.53	
Descrizione Guarnizione di precamera	

ARX.10.10	
Descrizione Spazzola a pavimento	

ARX.10.54	
Descrizione Angolo prestampato guarnizione di precamera	

ARX.10.12	
Descrizione Guarnizione vetro interna spessore 3 - 4 mm.	

ARX.10.55	
Descrizione Guarnizione PVC porta spazzolino	

ARX.10.13	
Descrizione Guarnizione vetro interna spessore 5 - 6 mm.	

ARX.10.56	
Descrizione Guarnizione di tenuta zoccolo	

ARX.10.14	
Descrizione Guarnizione vetro interna spessore 7 - 8 mm.	

ARX.10.57	
Descrizione Guarnizione giunzione profili	

ARX.10.15	
Descrizione Guarnizione vetro interna spessore 9 - 10 mm.	

--	--

ARX.10.28	
Descrizione Guarnizione vetro esterna coestrusa spessore 1.5 mm.	

--	--

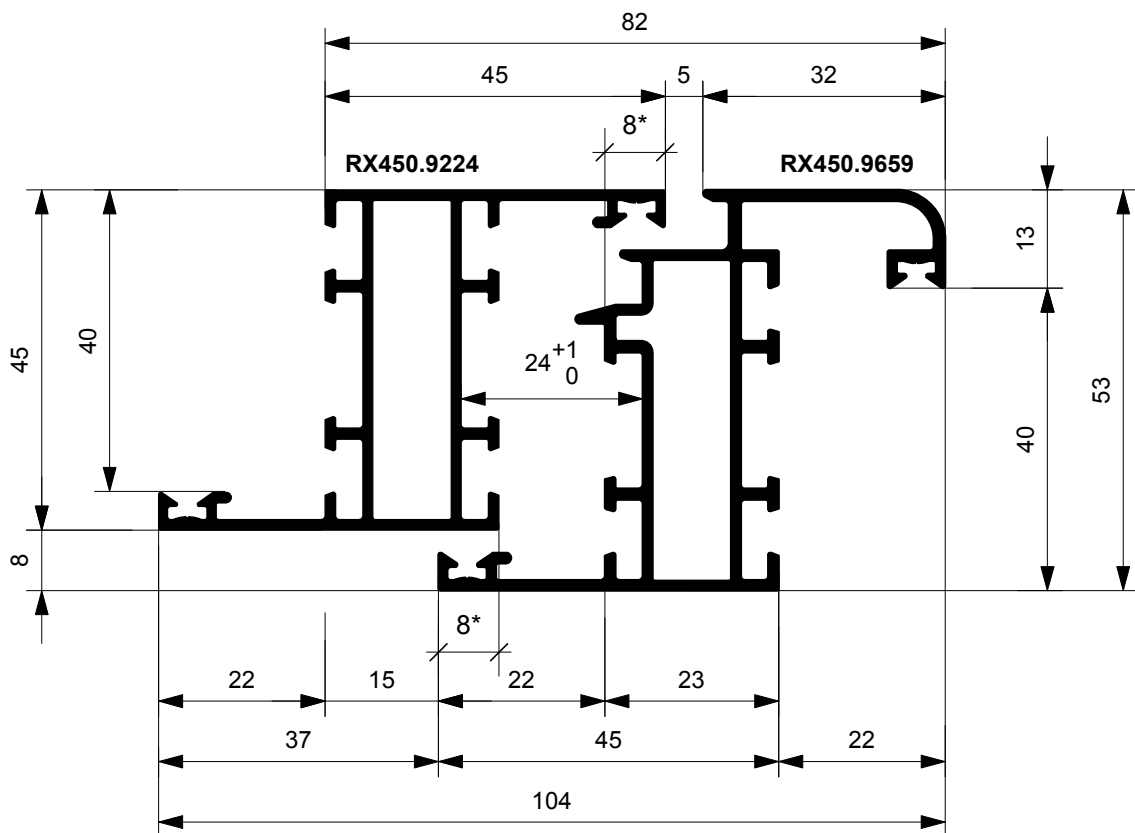

Schema dimensionale valido per distinte di taglio ed inserimento accessori.

* Portare a mm. 7.5 in caso di realizzazione finestra ad anta ribalta .



FINESTRA A DUE ANTE
Giunto Aperto

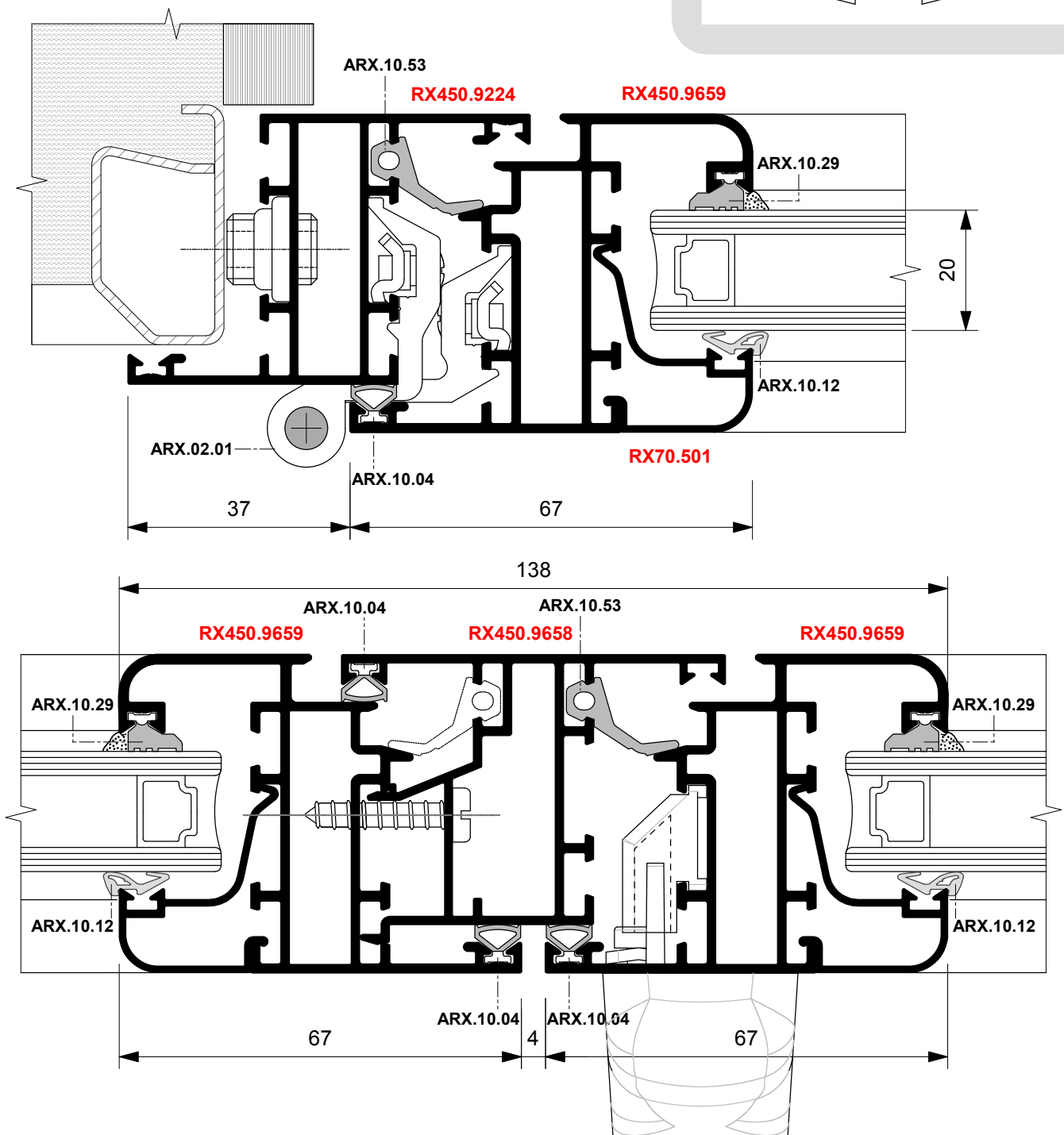
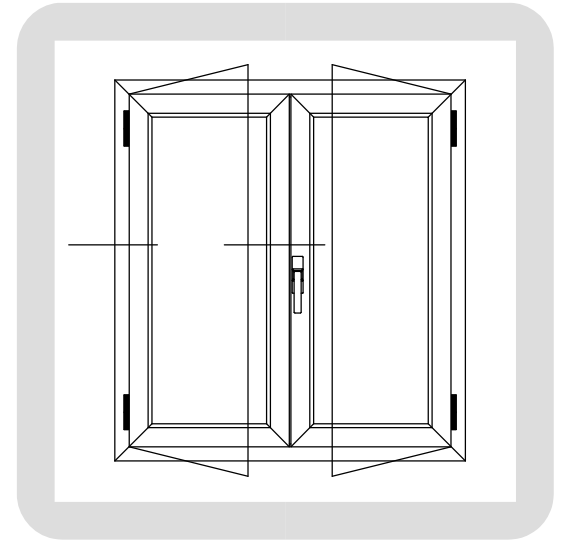

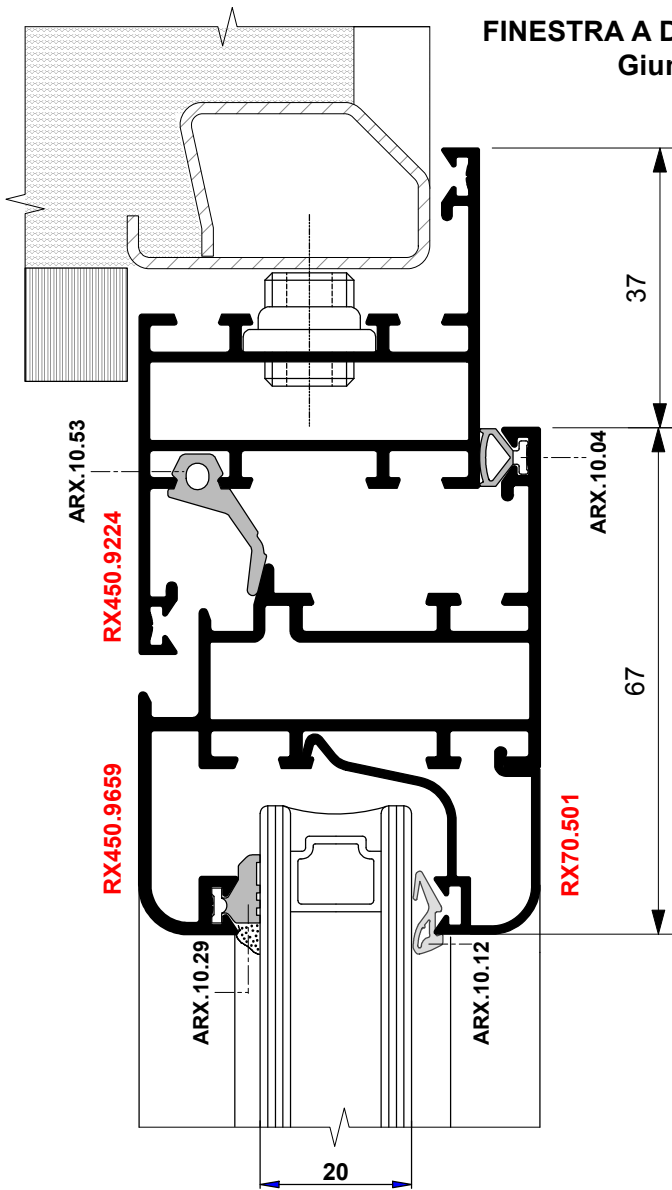

FINESTRA A DUE ANTE
Giunto Aperto

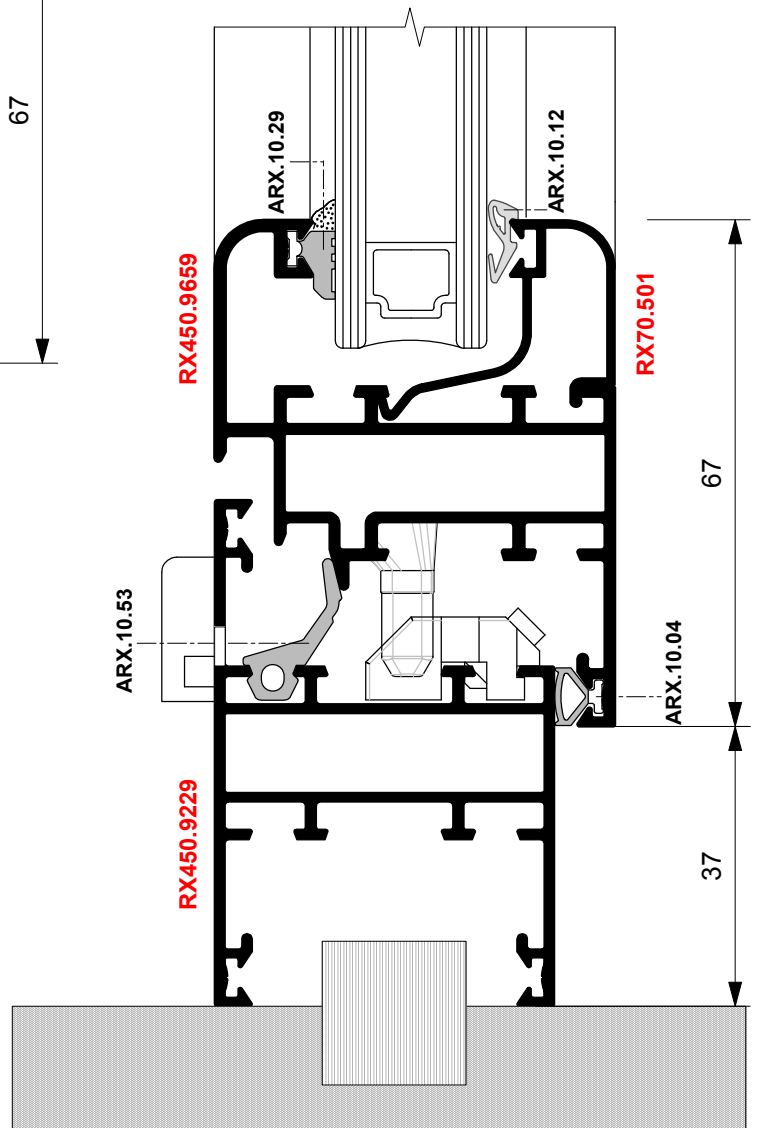
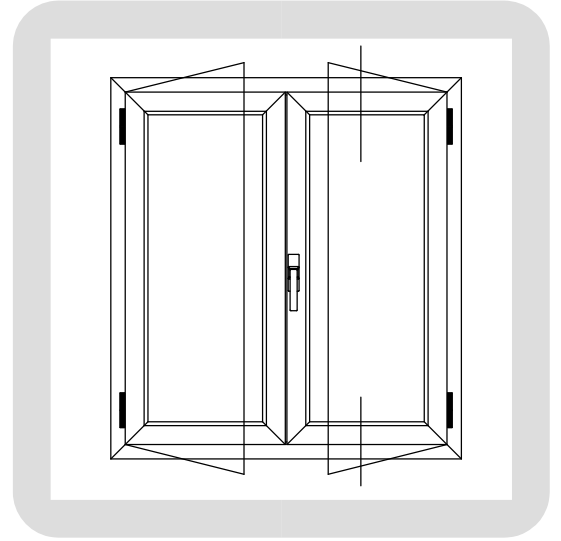

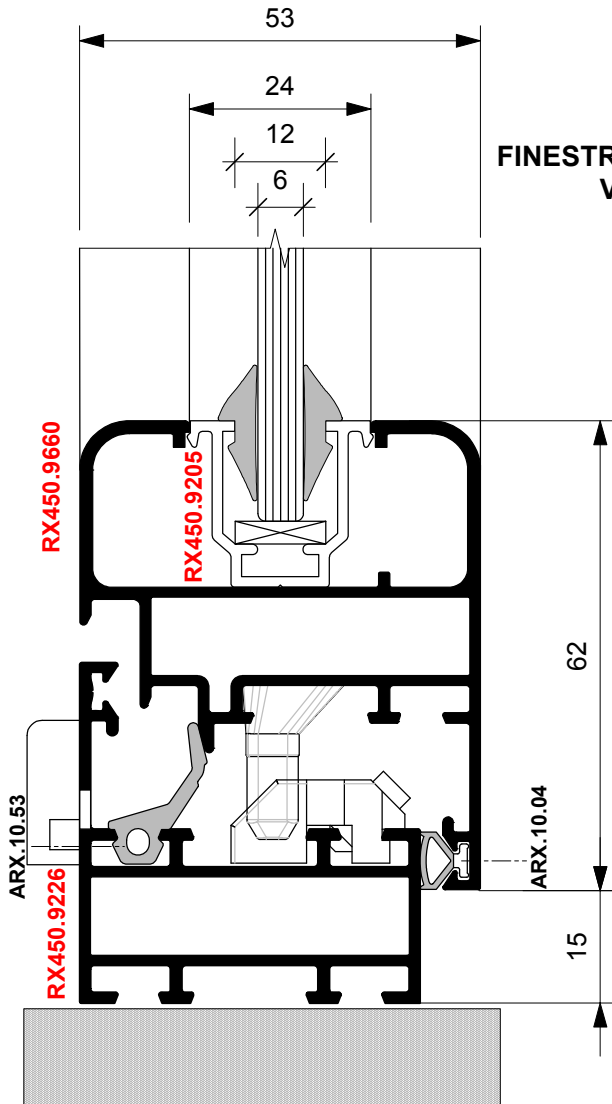

FINESTRA A DUE ANTE
Vetro ad Infilare

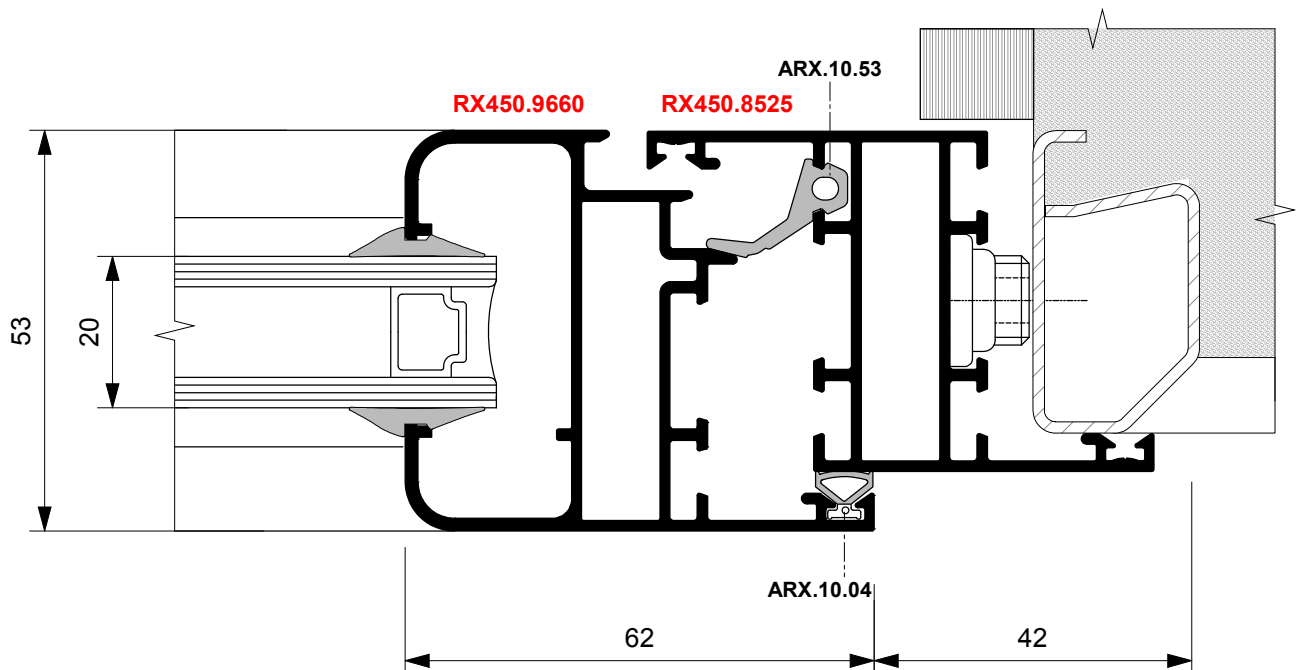
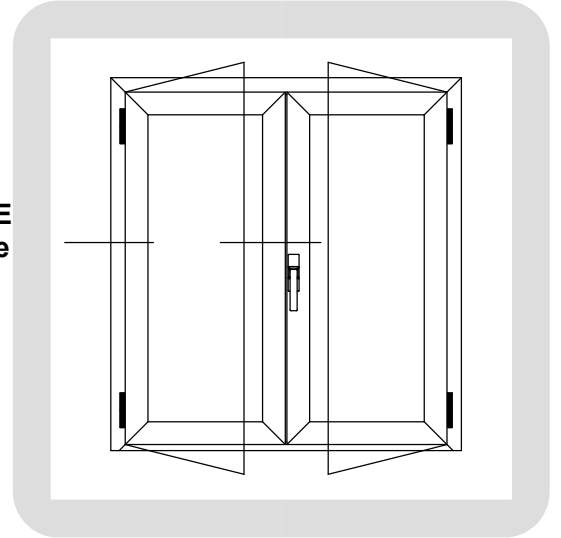



PERSIANA "NACO"

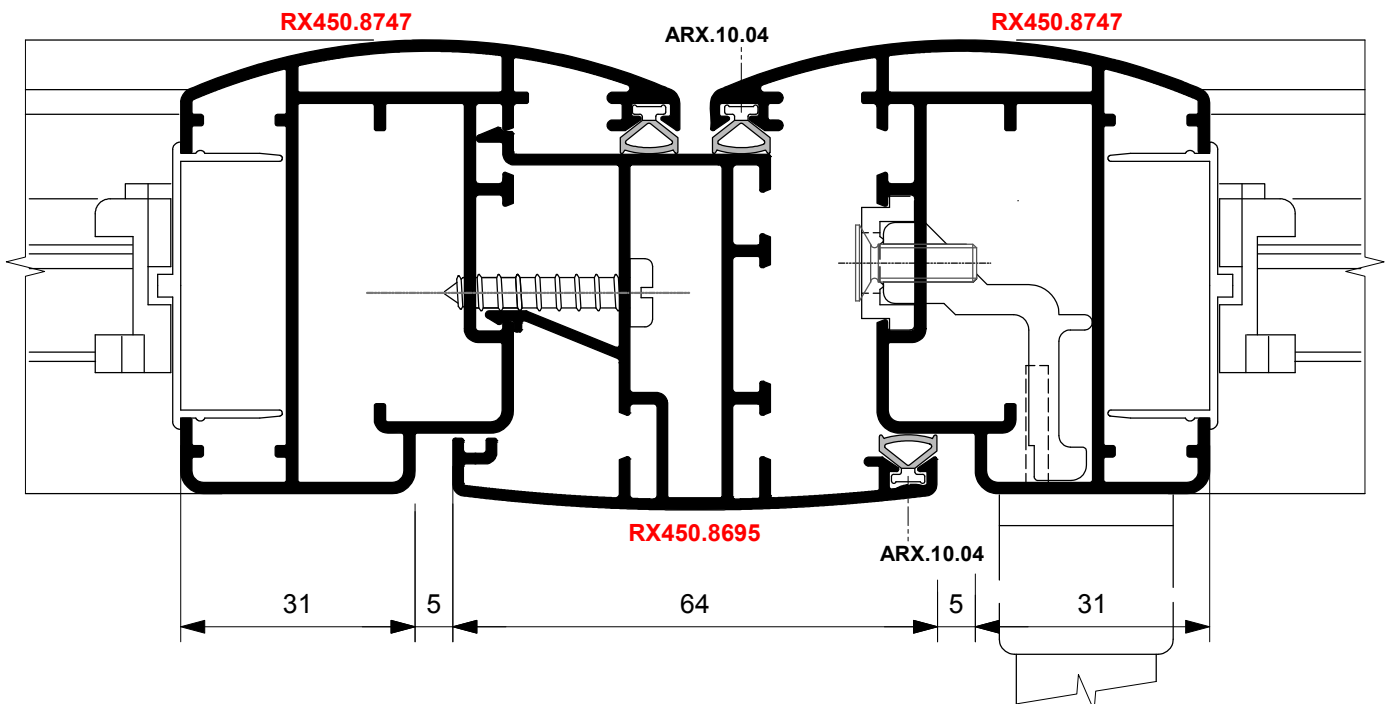
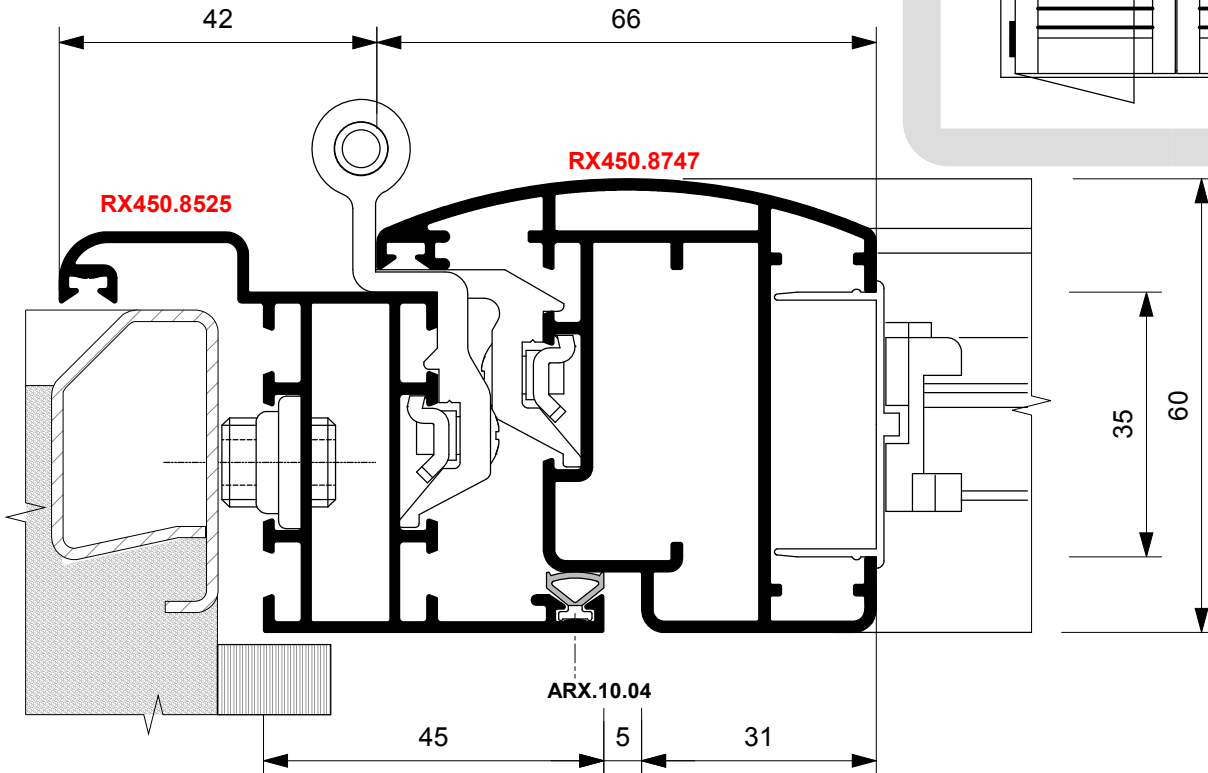
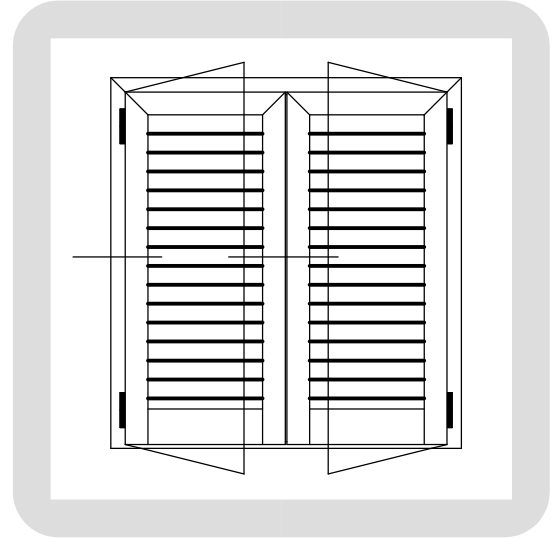

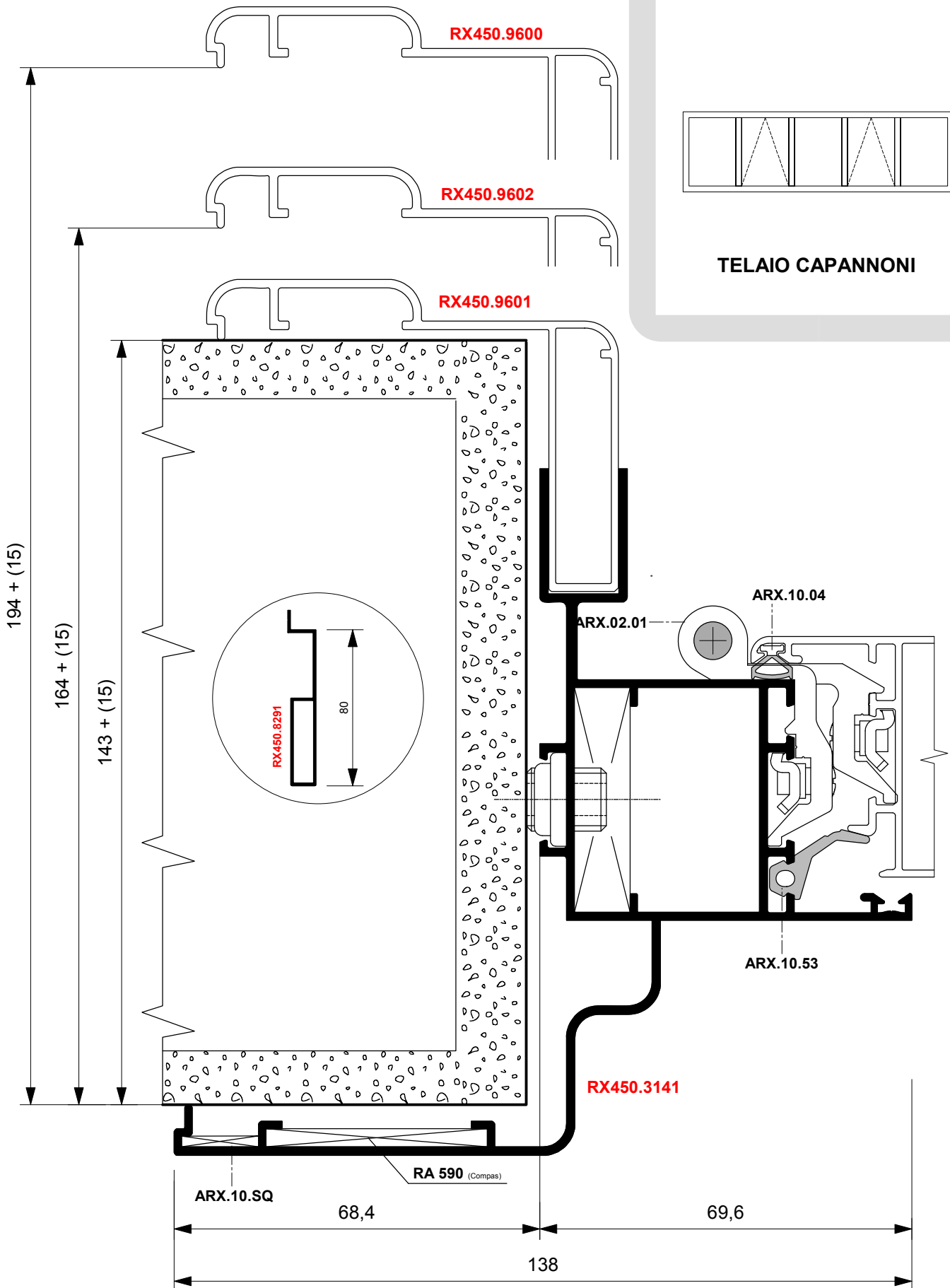



FINESTRA A DUE ANTE
Doppia Battuta

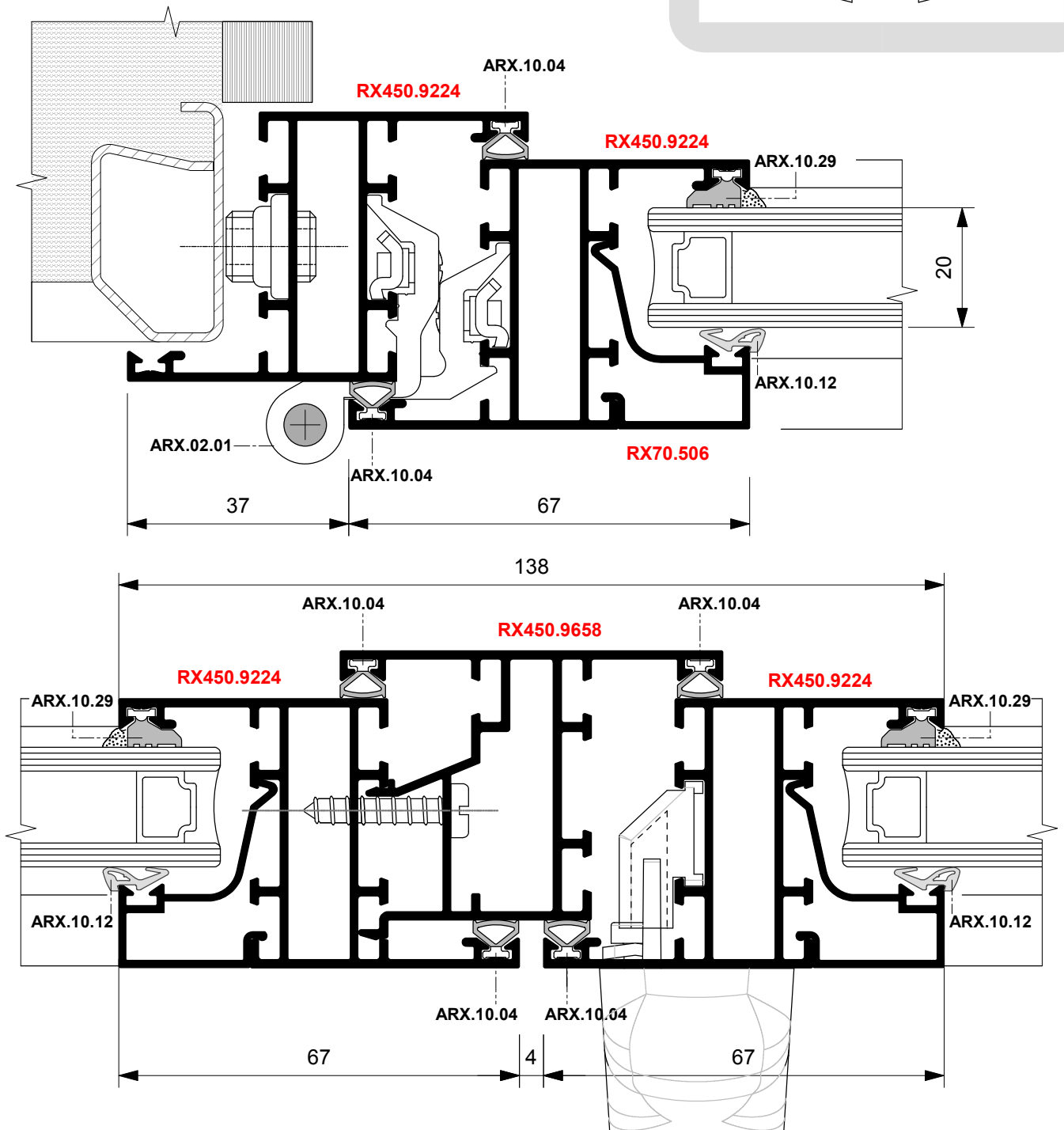
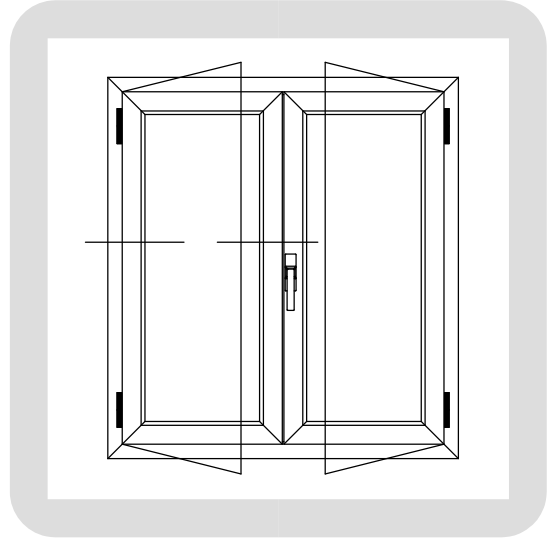



FINESTRA A DUE ANTE
Doppia Battuta

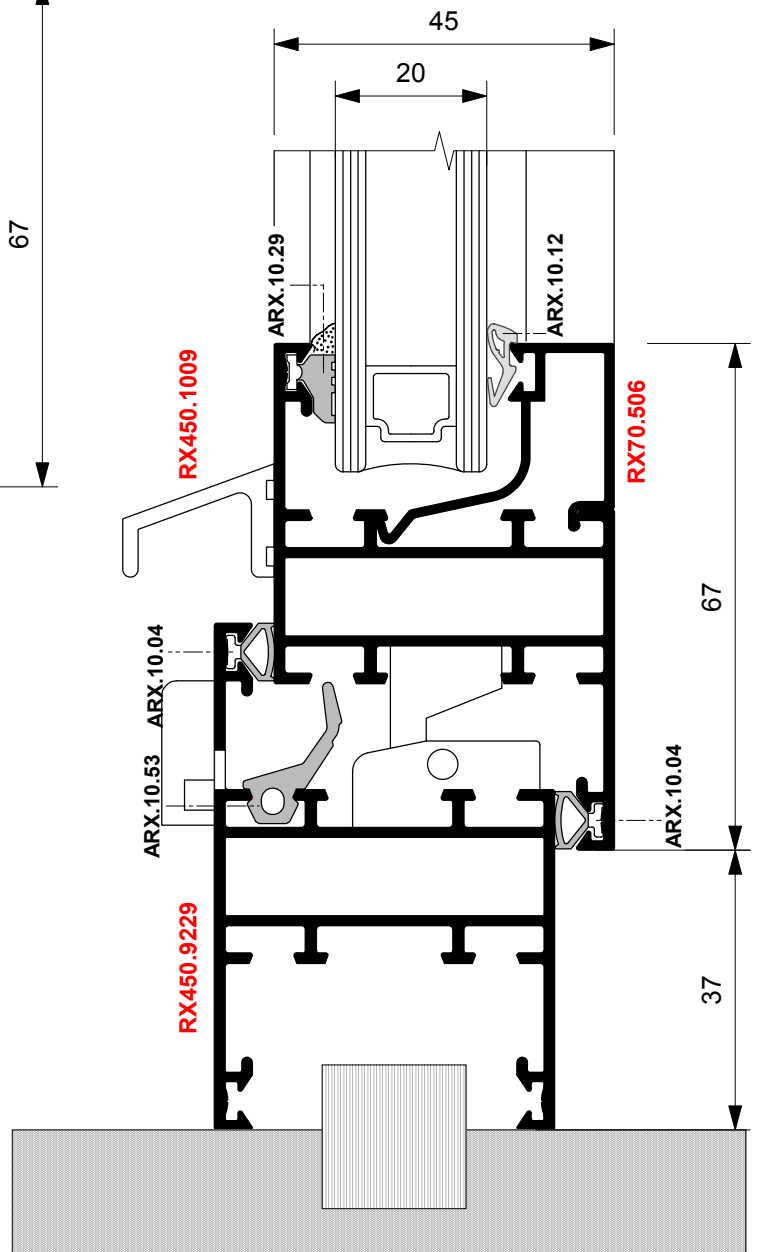
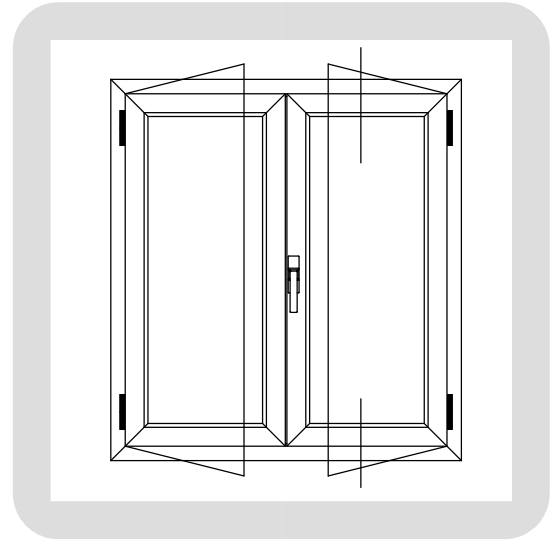
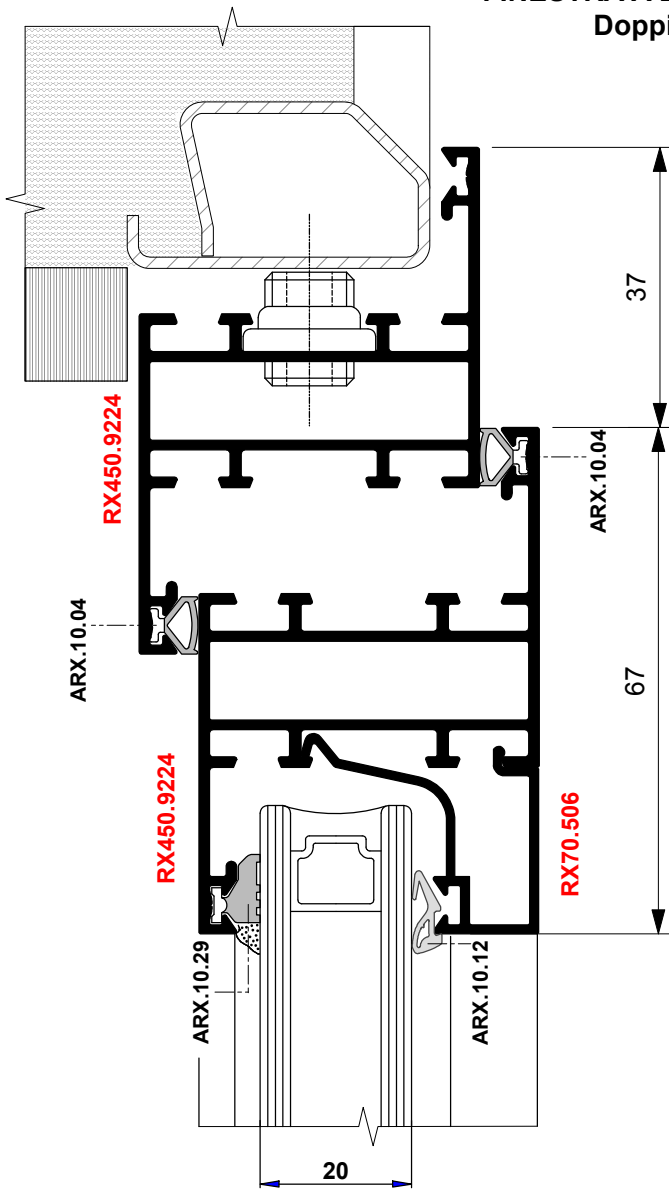



PORTA BALCONE A DUE ANTE
Giunto Aperto Vetro ad Infilare

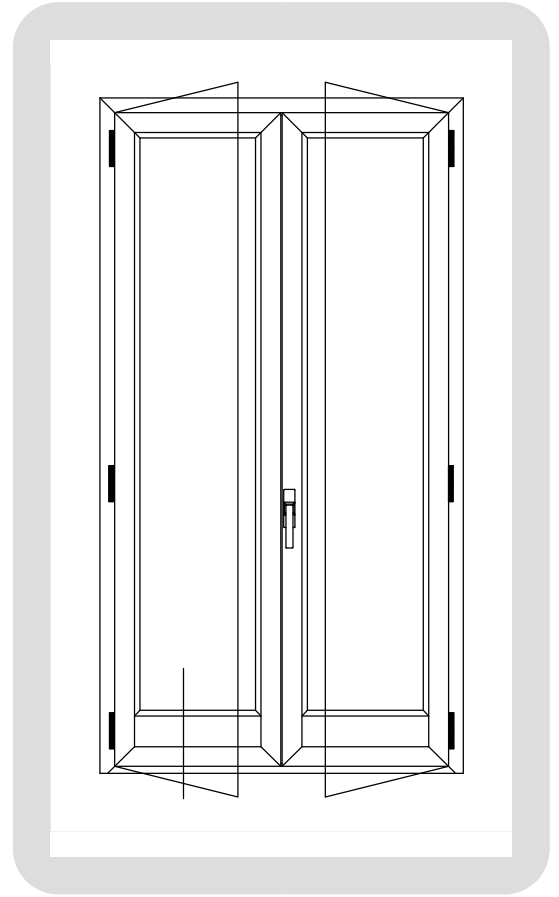
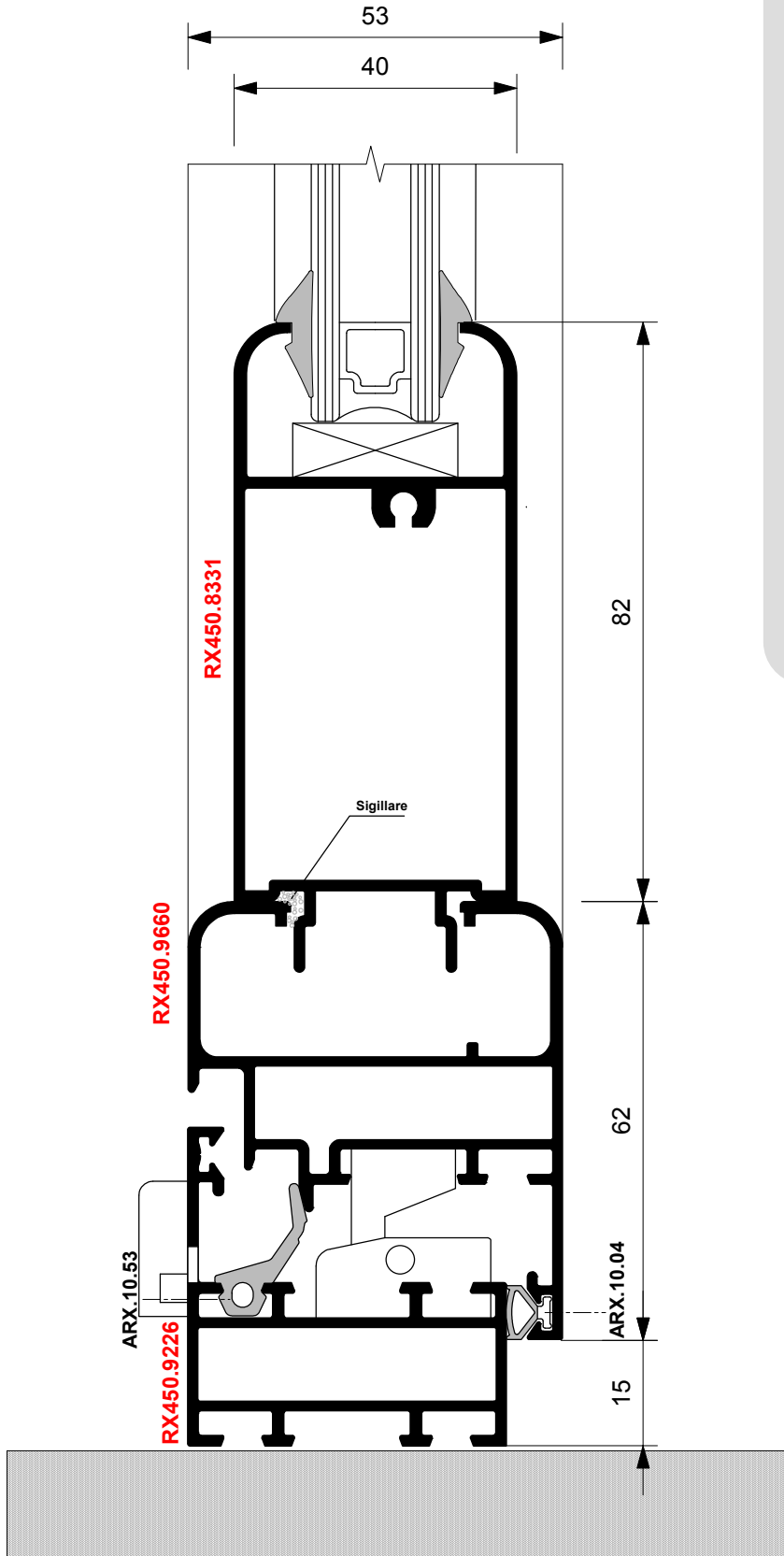



PORTA BALCONE A DUE ANTE
Giunto Aperto

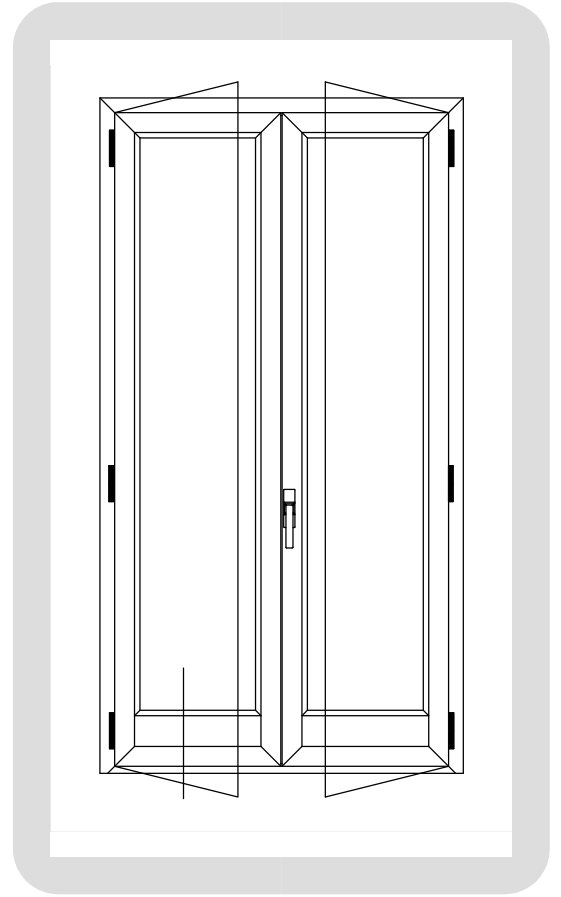
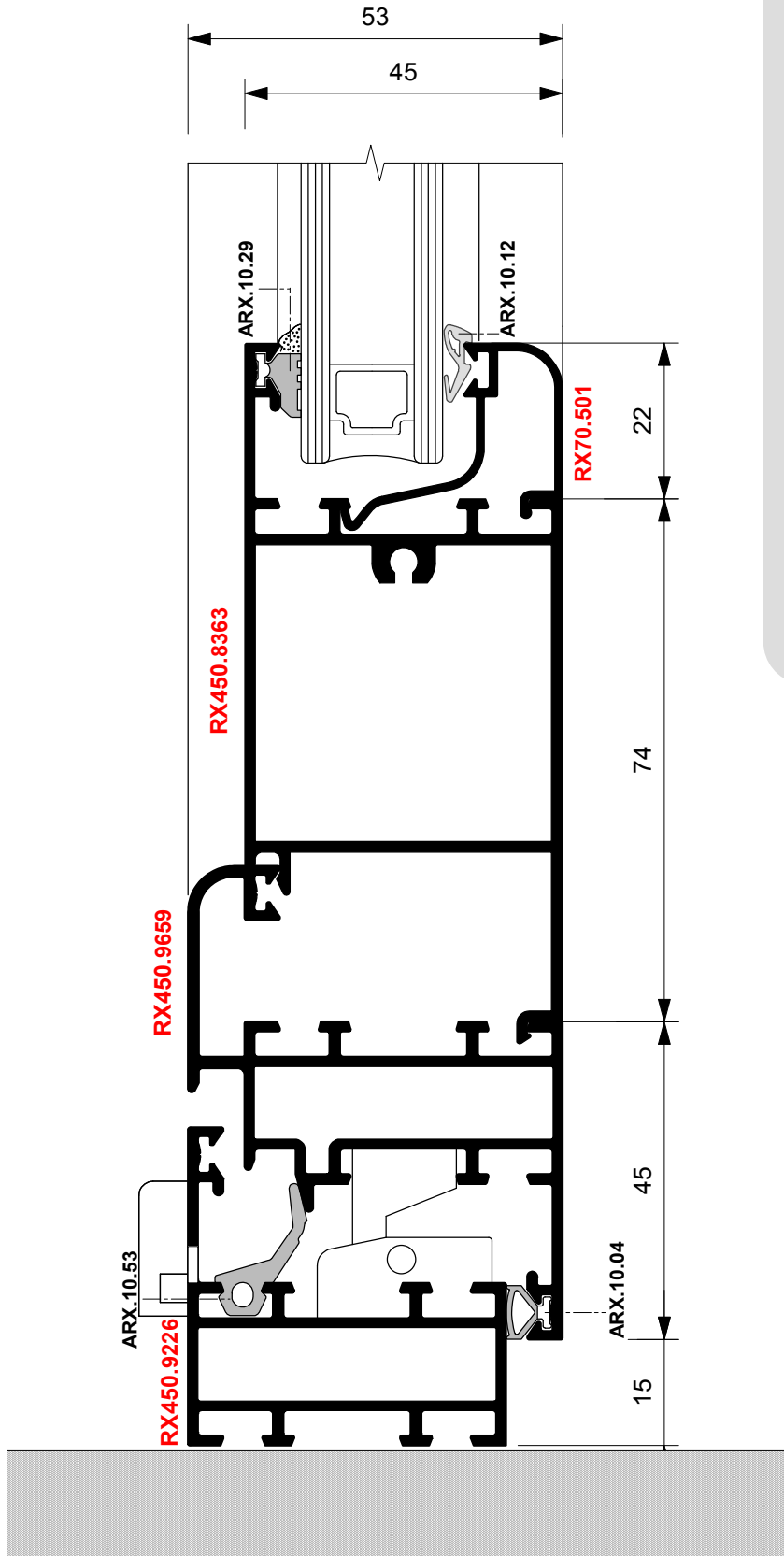



PORTA BALCONE A DUE ANTE
Doppio Sormonto

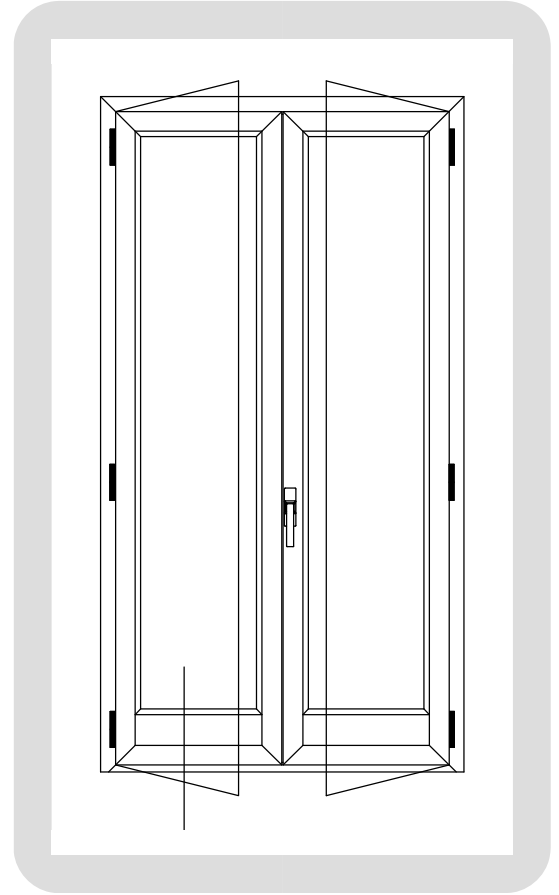
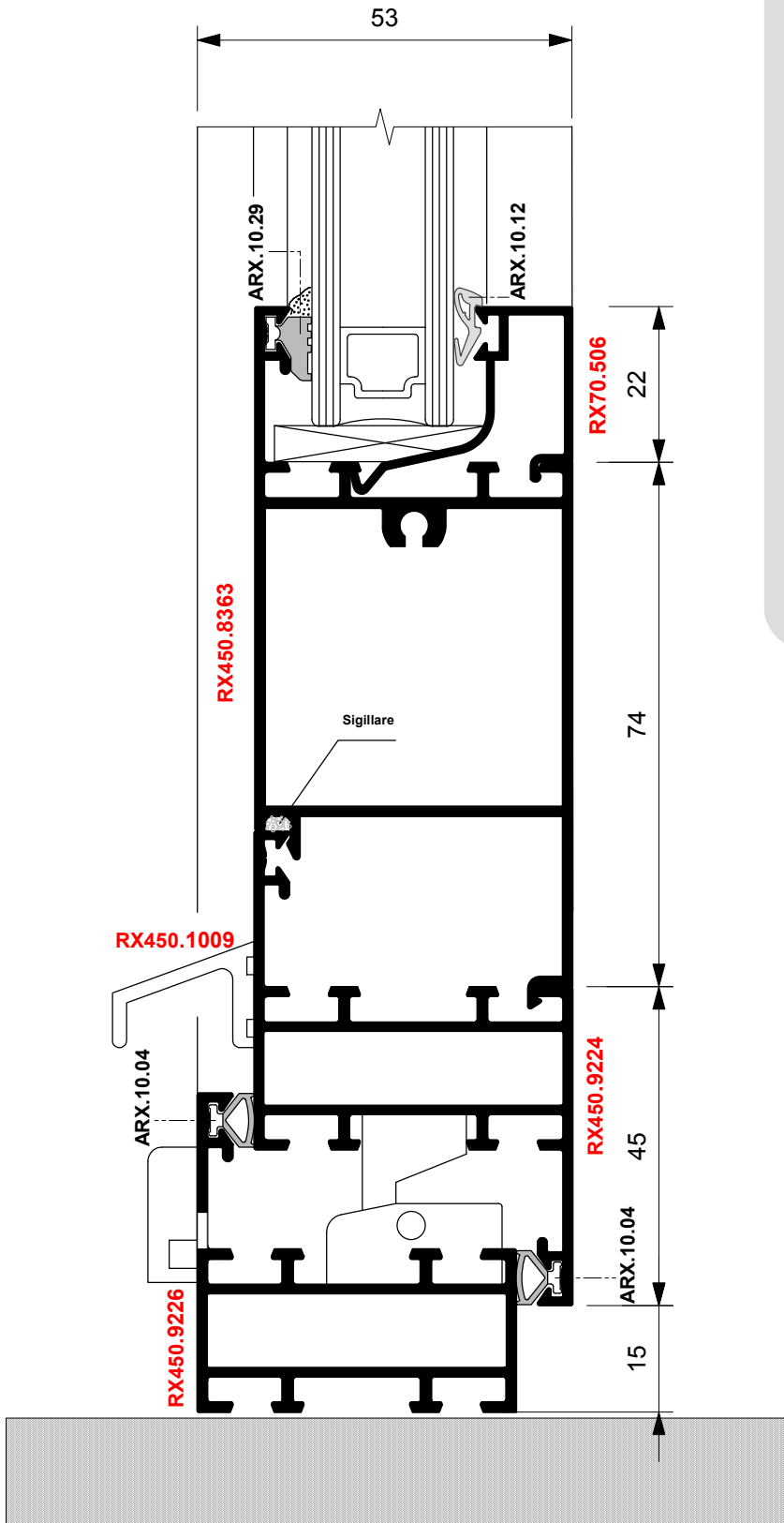



**APERTURA ESTERNA
CON SOPRALUCE**

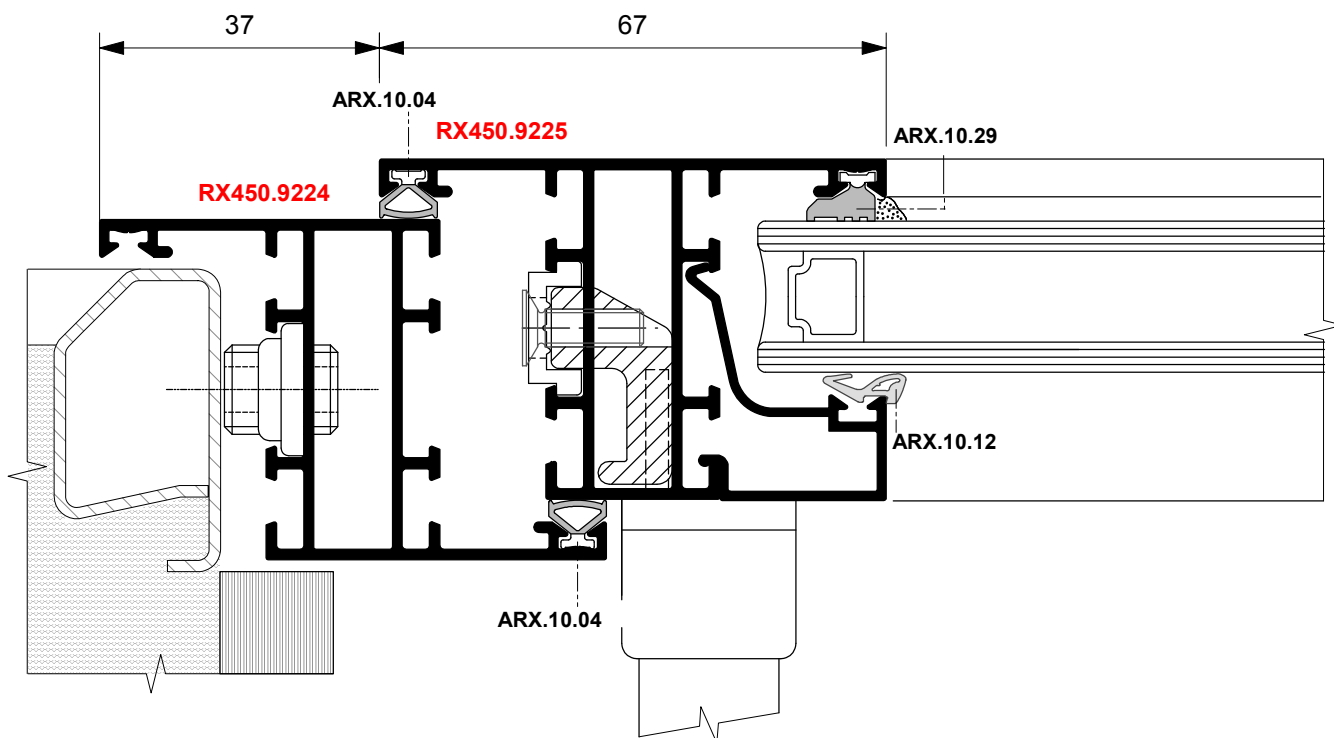
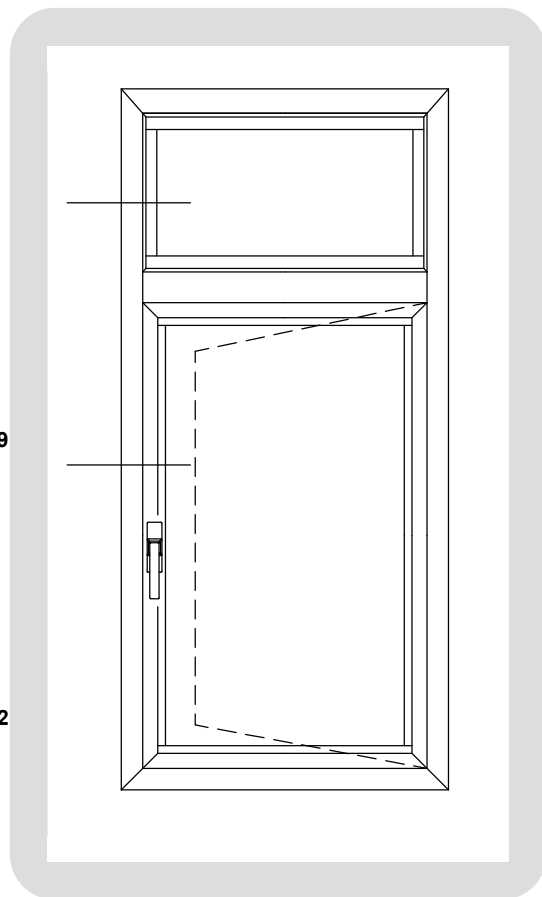
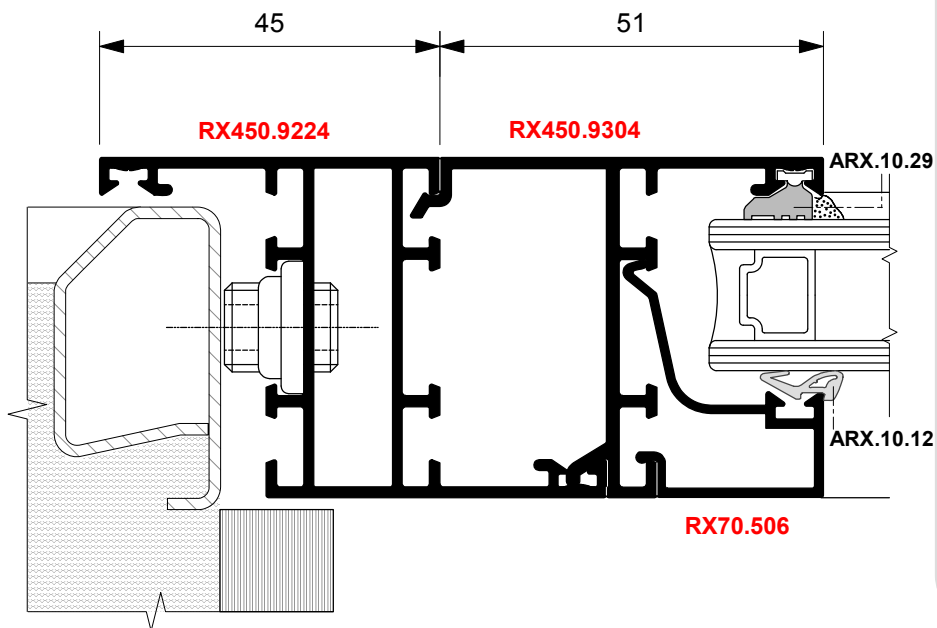



**APERTURA ESTERNA
CON SOPRALUCE**

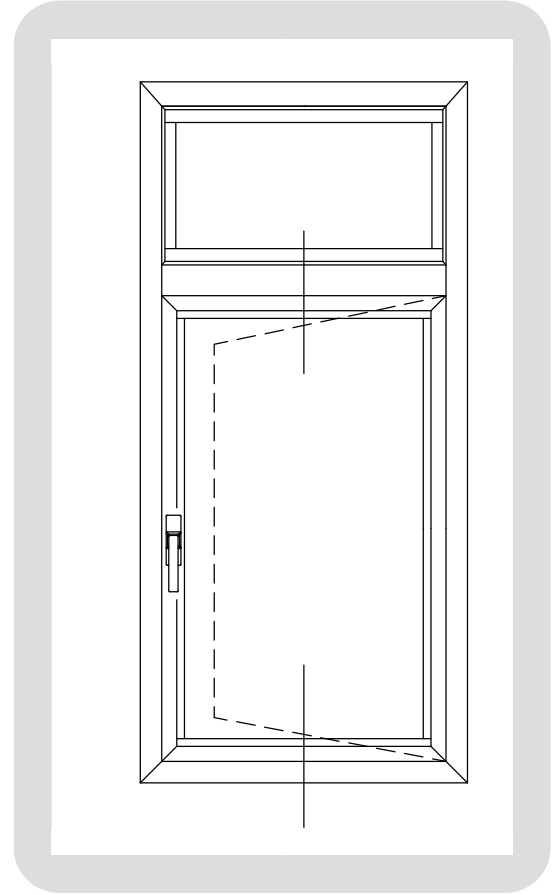
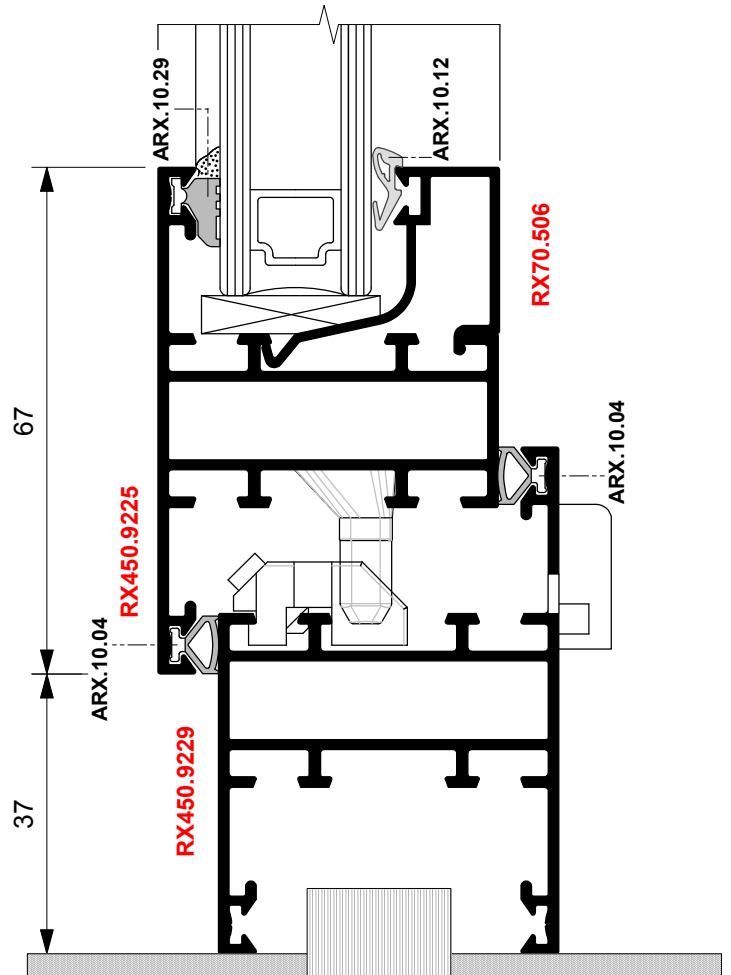
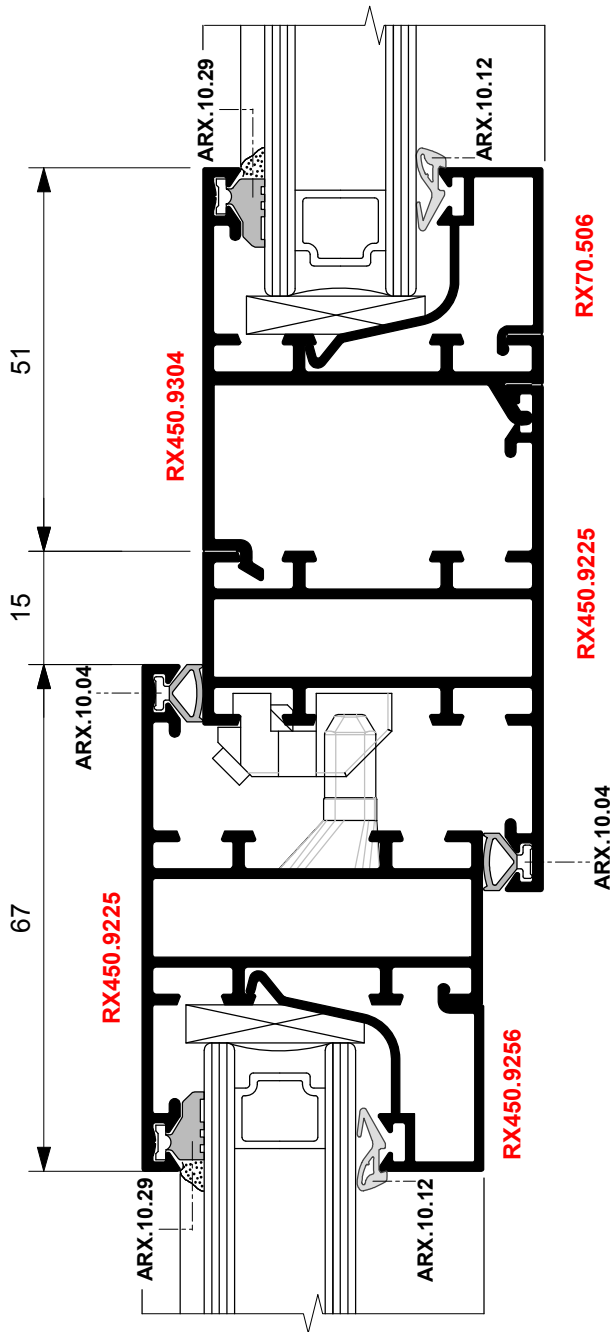



PORTE A VENTO

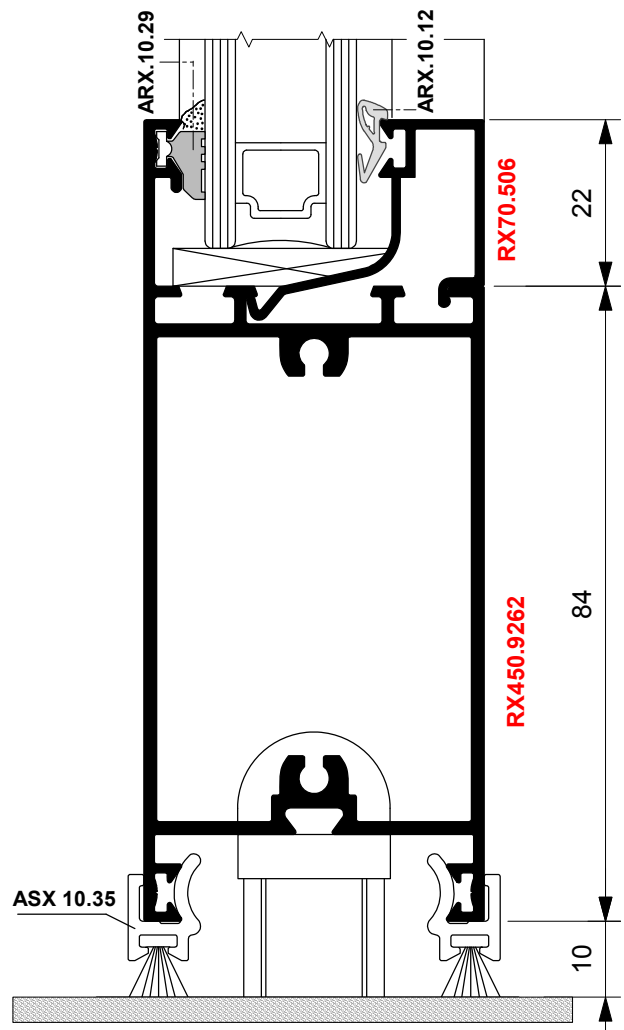
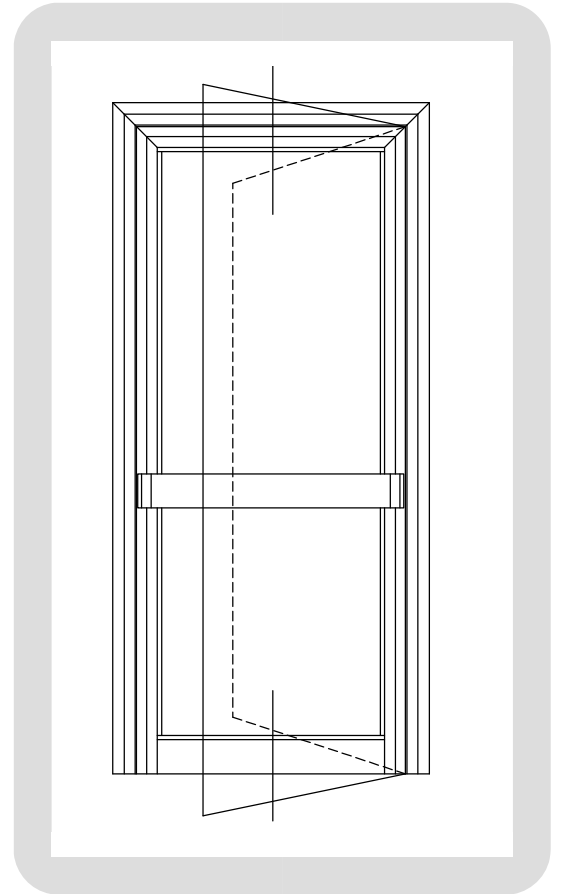
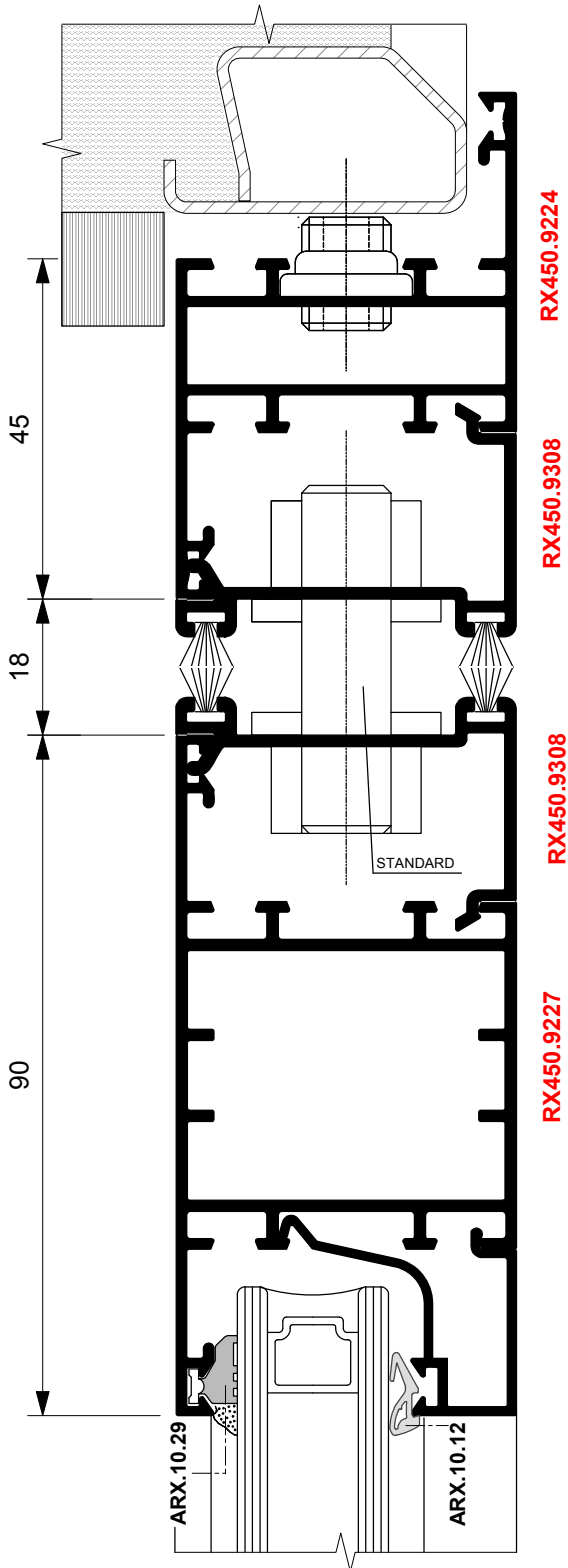

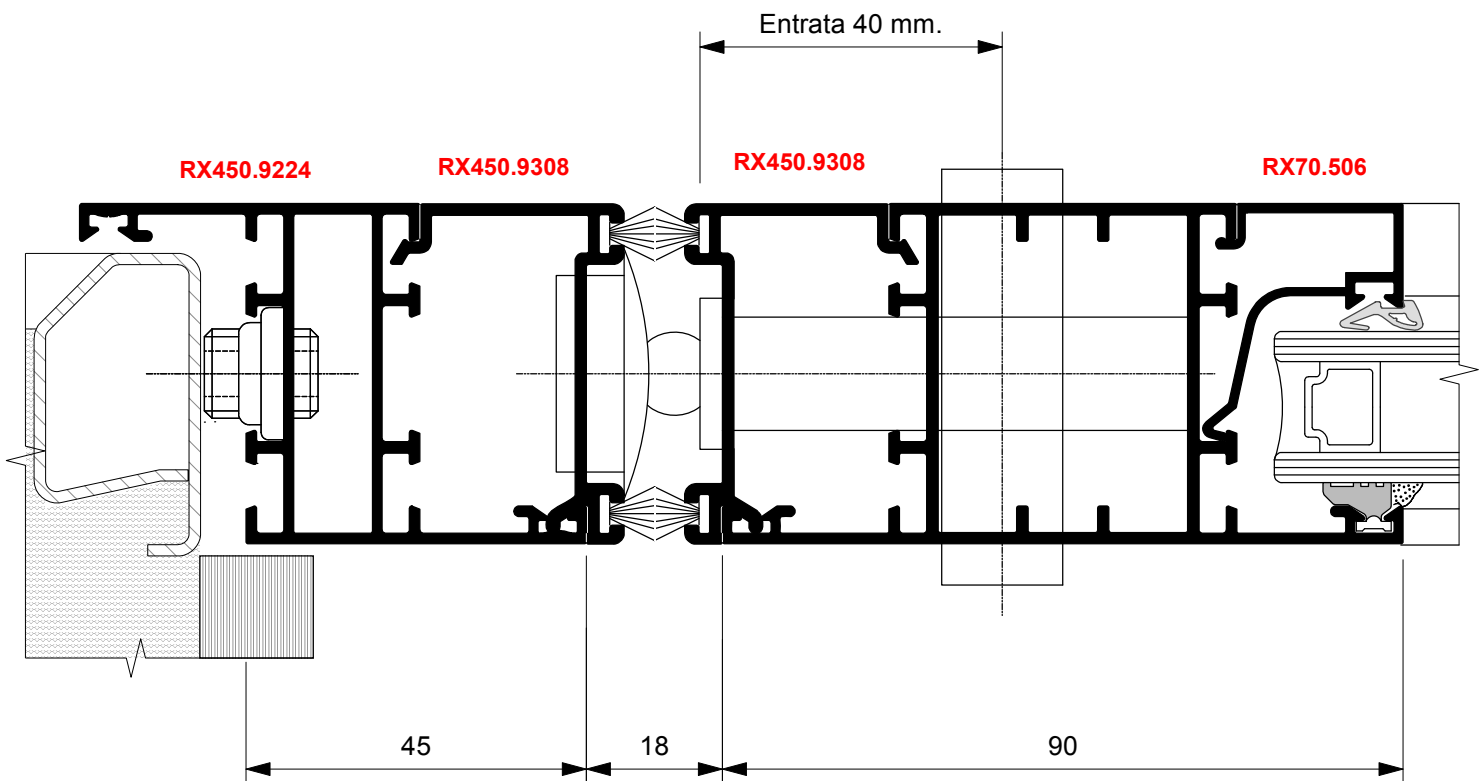
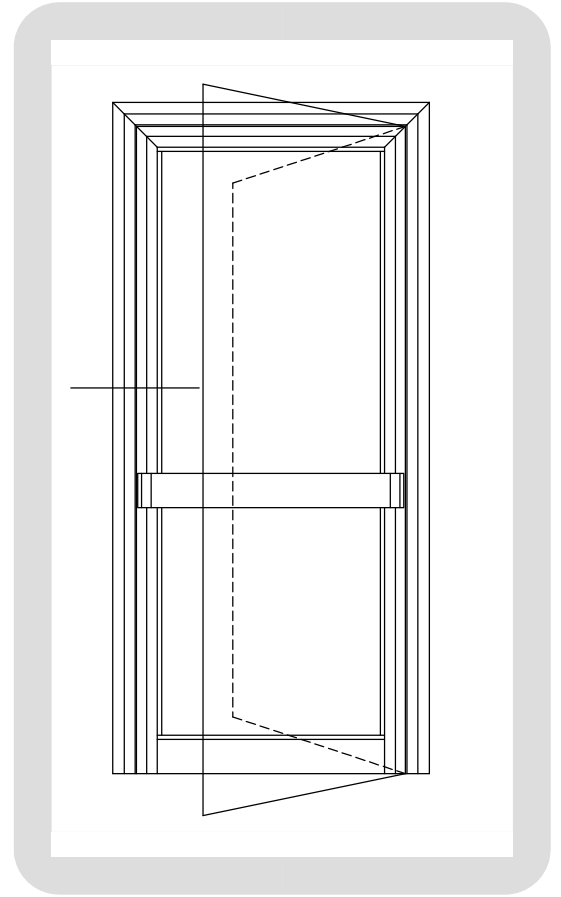



PORTA
Soglia e Battuta Ripotata

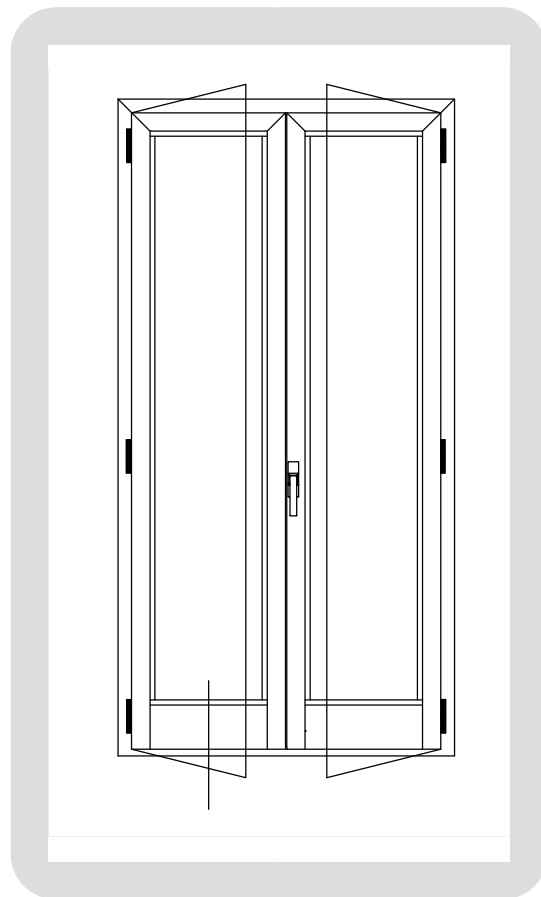
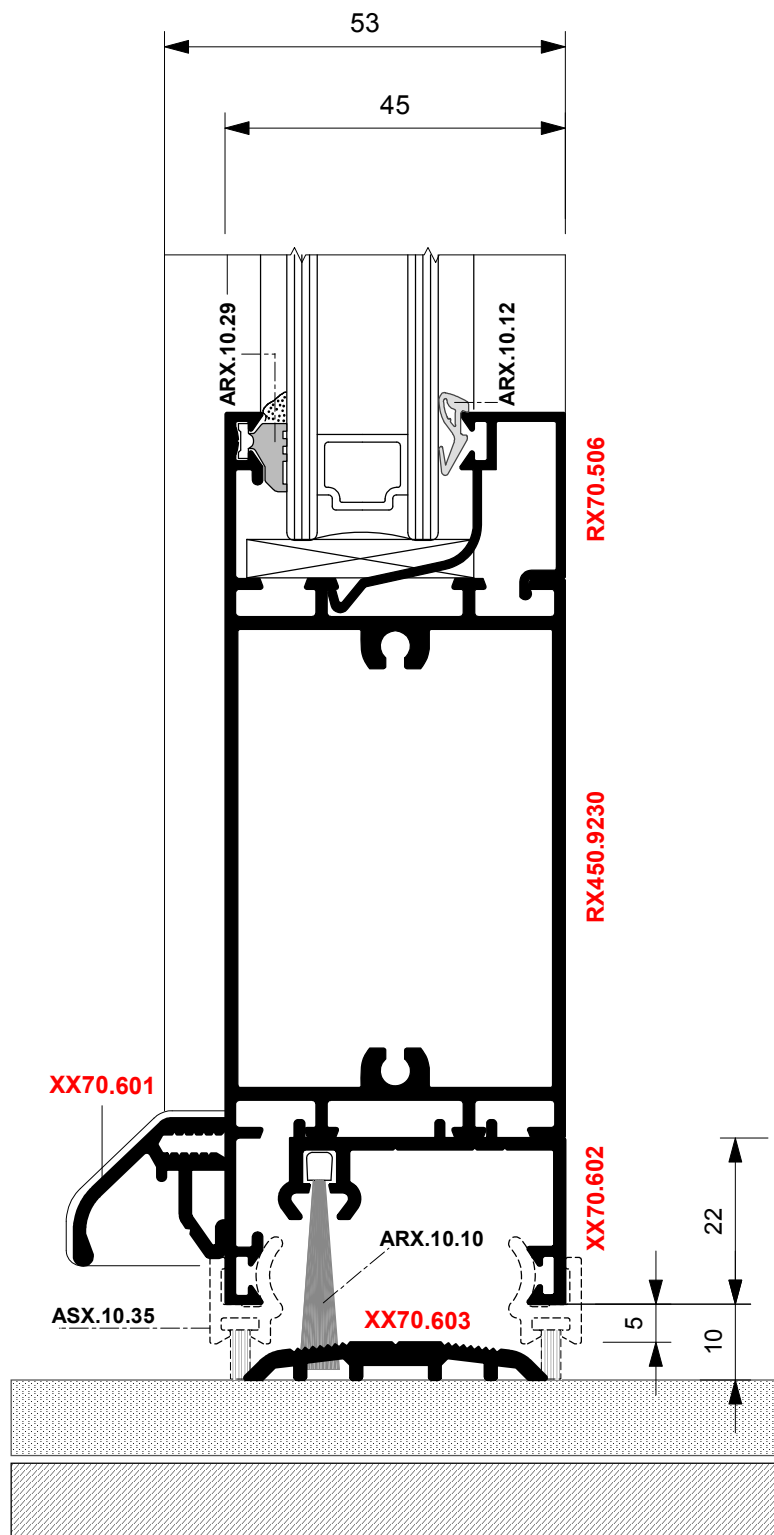

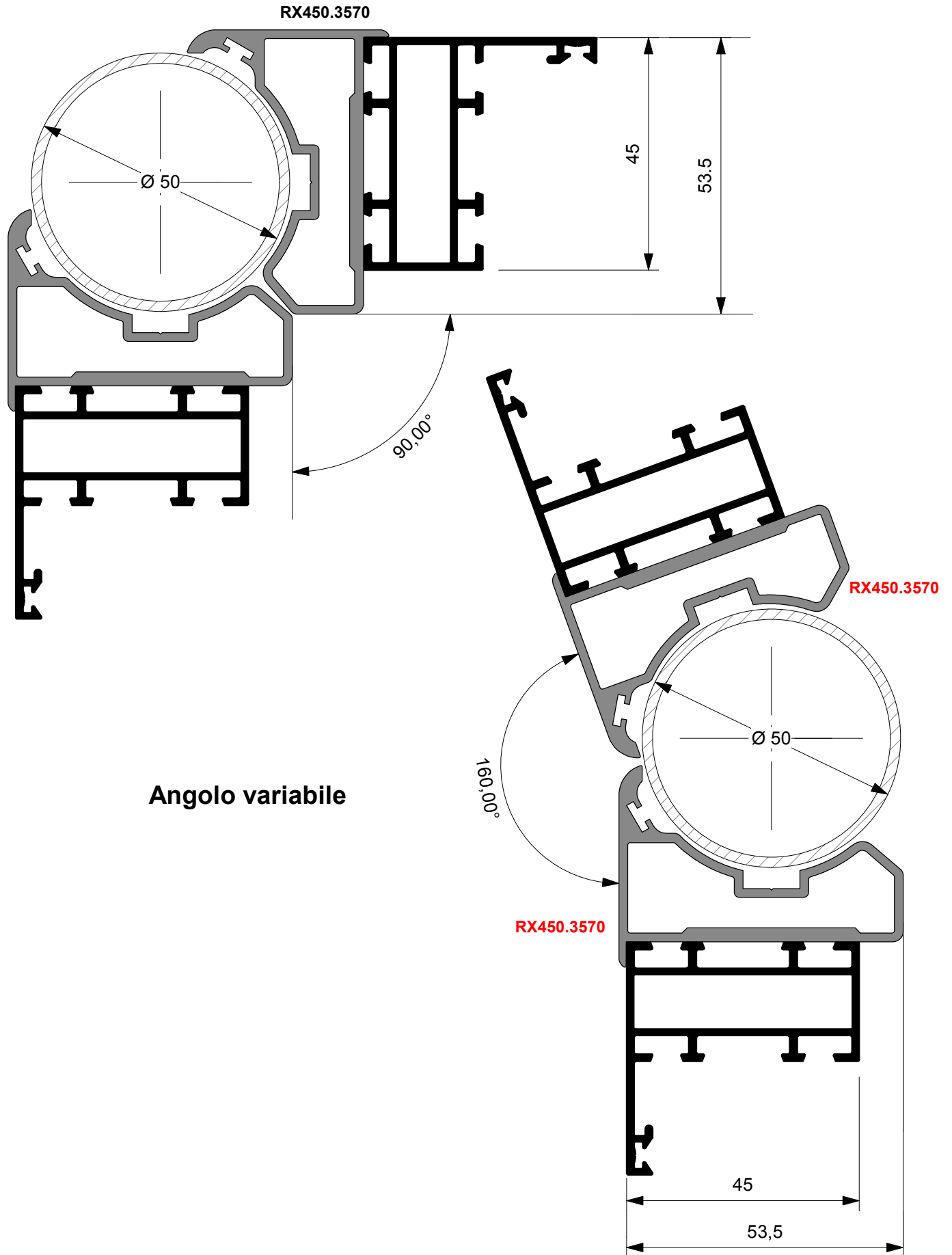



PORTA APERTUTA ESTERNA

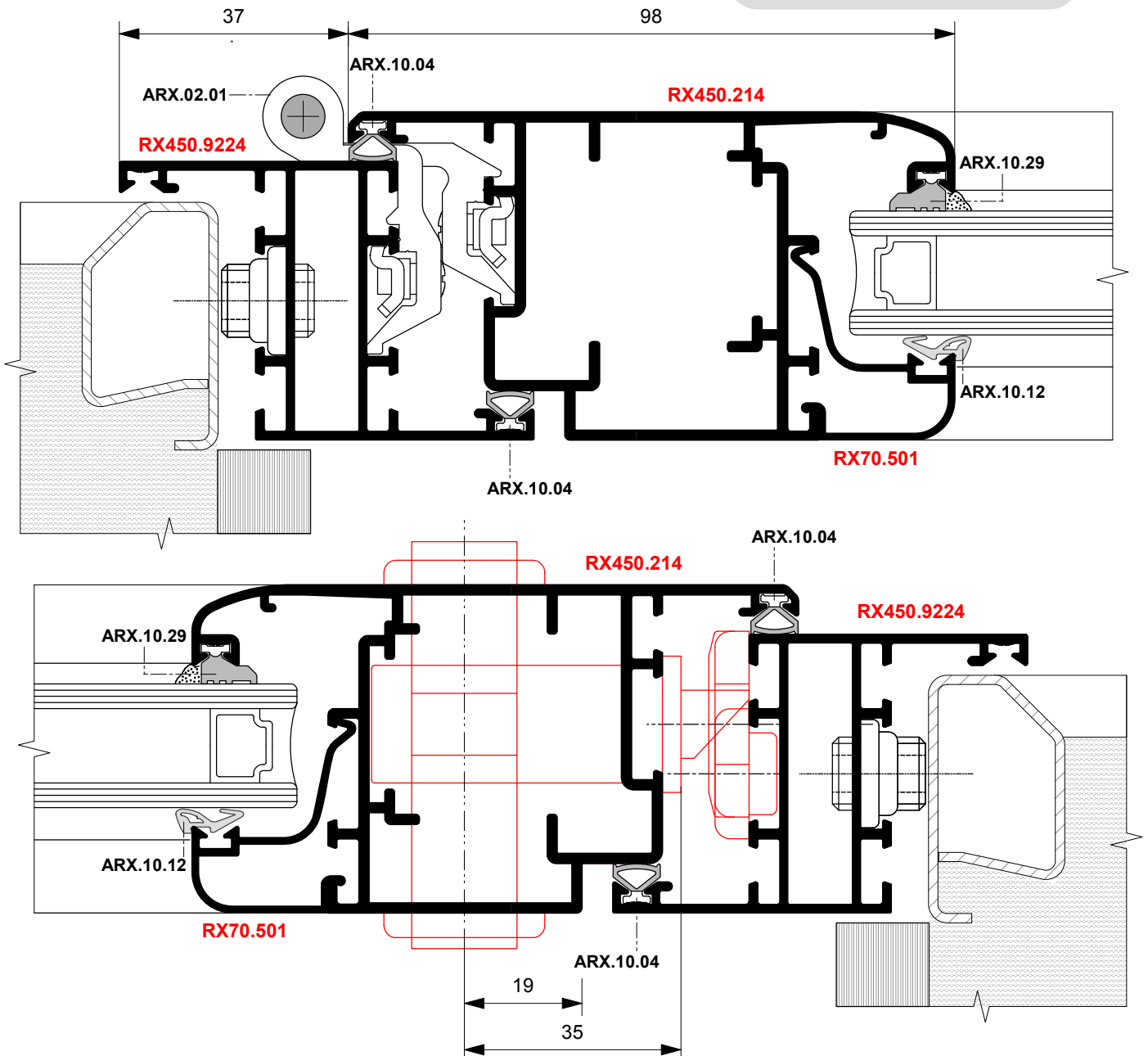
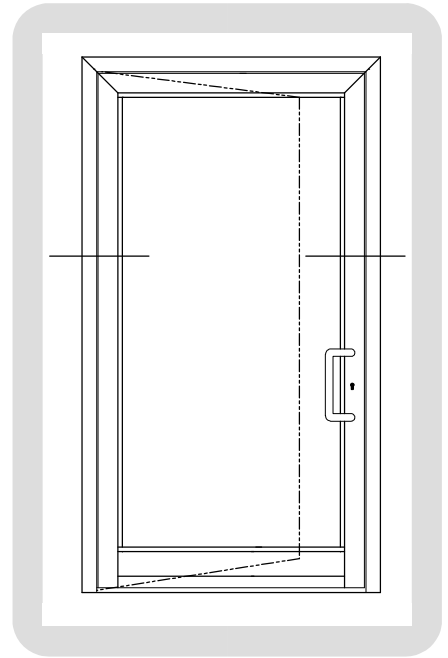

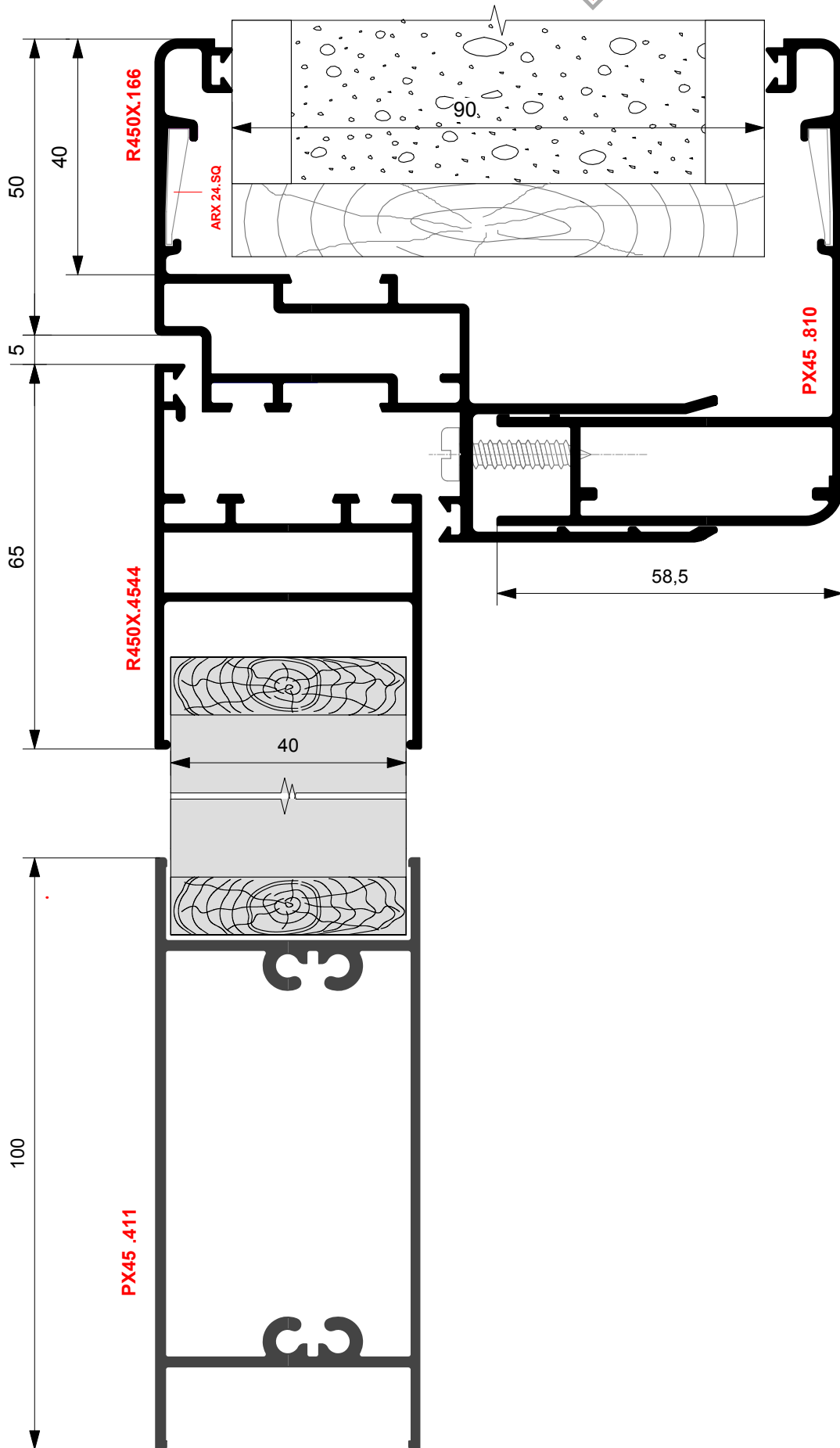

PORTA INTERNA

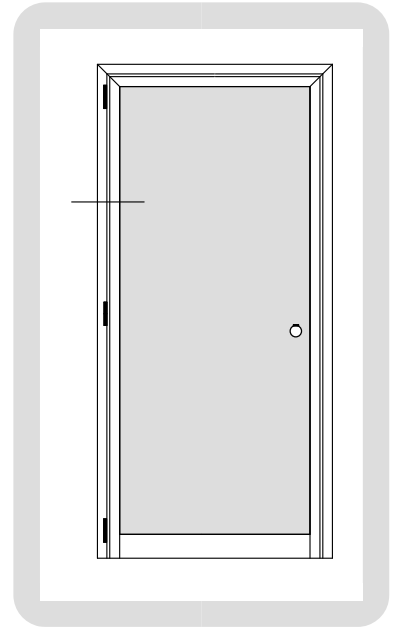



SEZ. B-B

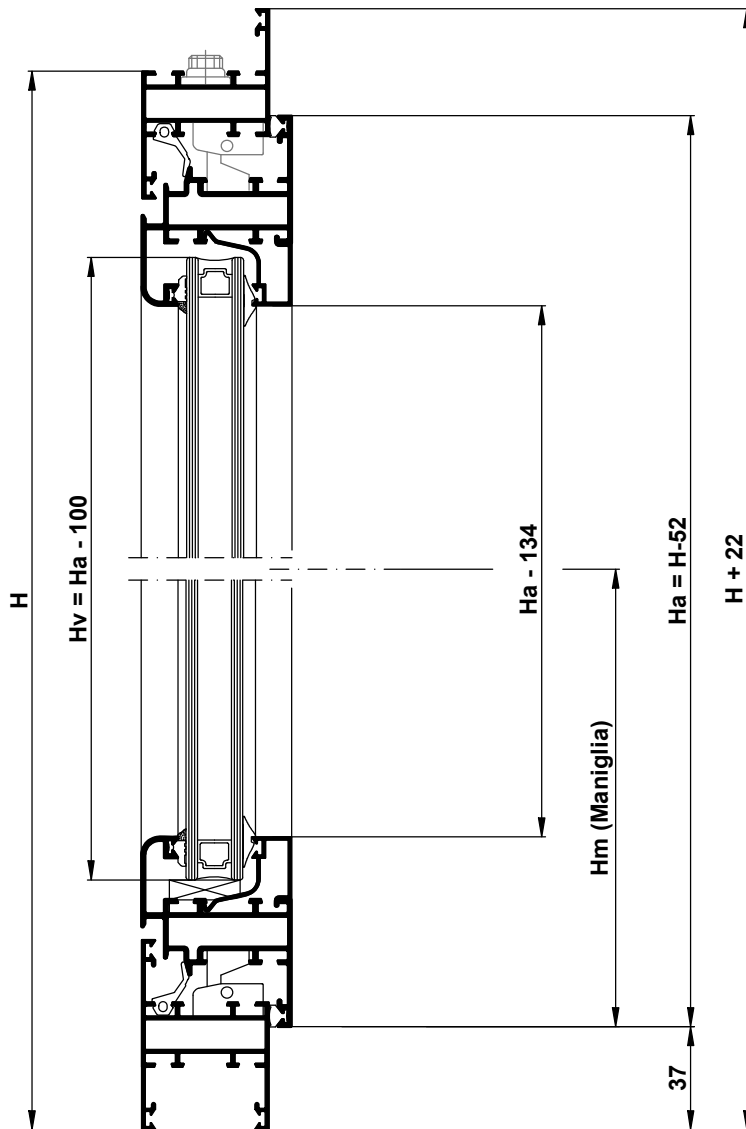

FINESTRA AD 1 ANTA

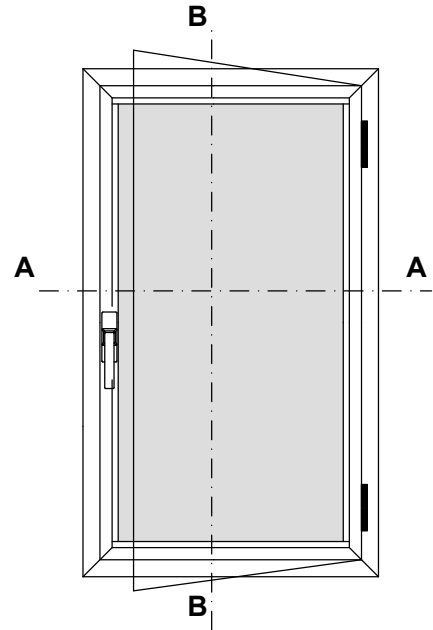

N.B.



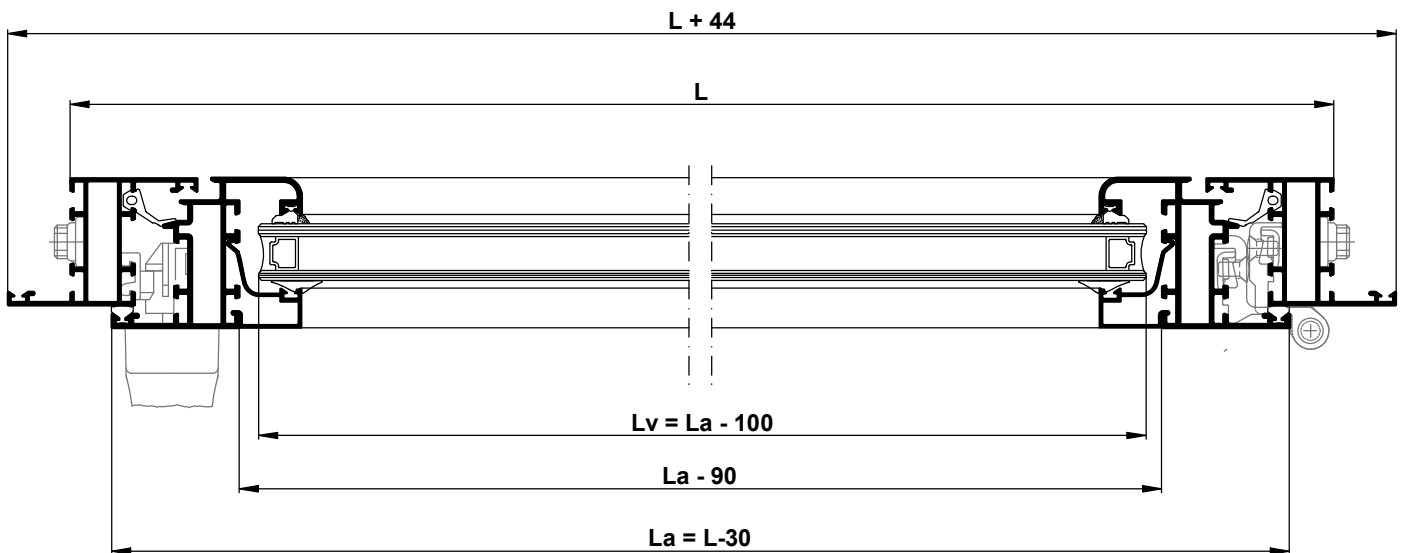

Spessore vetro considerato 20mm

Gioco perimetrale tra profilato in alluminio e vetro 5 mm

SEZ. A-A

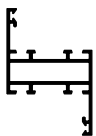
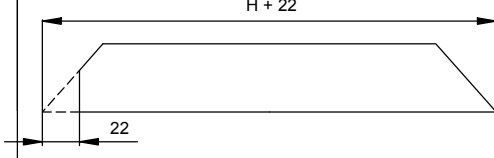
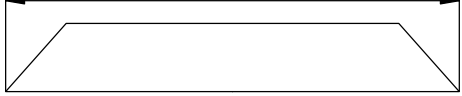
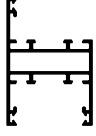
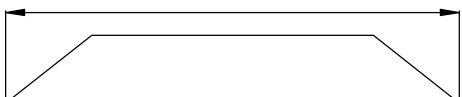
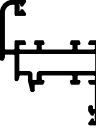
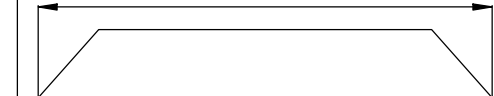
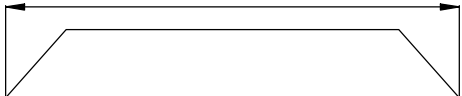

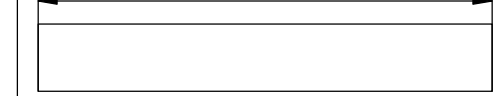
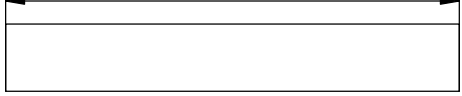

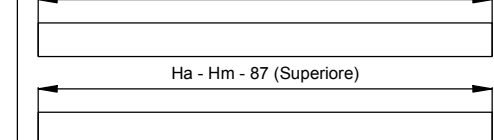
PROFILATO	N.Pz	TAGLIO	N.Pz	TAGLIO
RX450.9224 	2		1	
RX450.9225 			1	
RX450.9659 	2		2	
RX70.506 	2		2	
RX450.9221 	2			

ACCESSORI

ARTICOLO	DESCRIZIONE	N.	ARTICOLO	DESCRIZIONE	N.	ARTICOLO	DESCRIZIONE	N.
ARX 39.SQ	Squadretta in alluminio estruso inserto unificato	8	ARX 03.06	Cremonese reversibile apertura interna	1	Comm.le	Tasselli spessoramento vetro	4
ARX 10.16	Coppia innesti cremonese apertura interna	1	ARX 03.13	Riscontro in nylon con rullino per puntali	2			
ARX 03.12	Terminale asta	2	509.261.55	Paratempesta in nylon	2			
ARX 06.07	Basetta regolo mobile	8	ARX 06.09	Regolo mobile L = 20 mm	8			
ARX 10.54	Angolo stampato per guarnizione ARX 10.53	4	ARX 03.15	Riscontro terza chiusura su innesti	1			
ARX 02.01	Cerniera sfilabile	2						
ARX 10.SQ	Squadretta d' allineamento in nylon su aletta	10						
ARX 37.SQ	Squadretta d' allineamento lato esterno anta	4						

GUARNIZIONI

ARTICOLO	DESCRIZIONE	N.	ARTICOLO	DESCRIZIONE	N.	ARTICOLO	DESCRIZIONE	N.
ARX 10.29	Guarnizione appoggio vetri da 3 mm	2H - 2L	ARX 10.53	Guarnizione per precamera	2H - 2L			
ARX 10.12	Guarnizione su fermavetro spessore 3 mm	2H - 2L	ARX 10.04	Guarnizione di battuta	2H - 2L			



SEZ. B-B

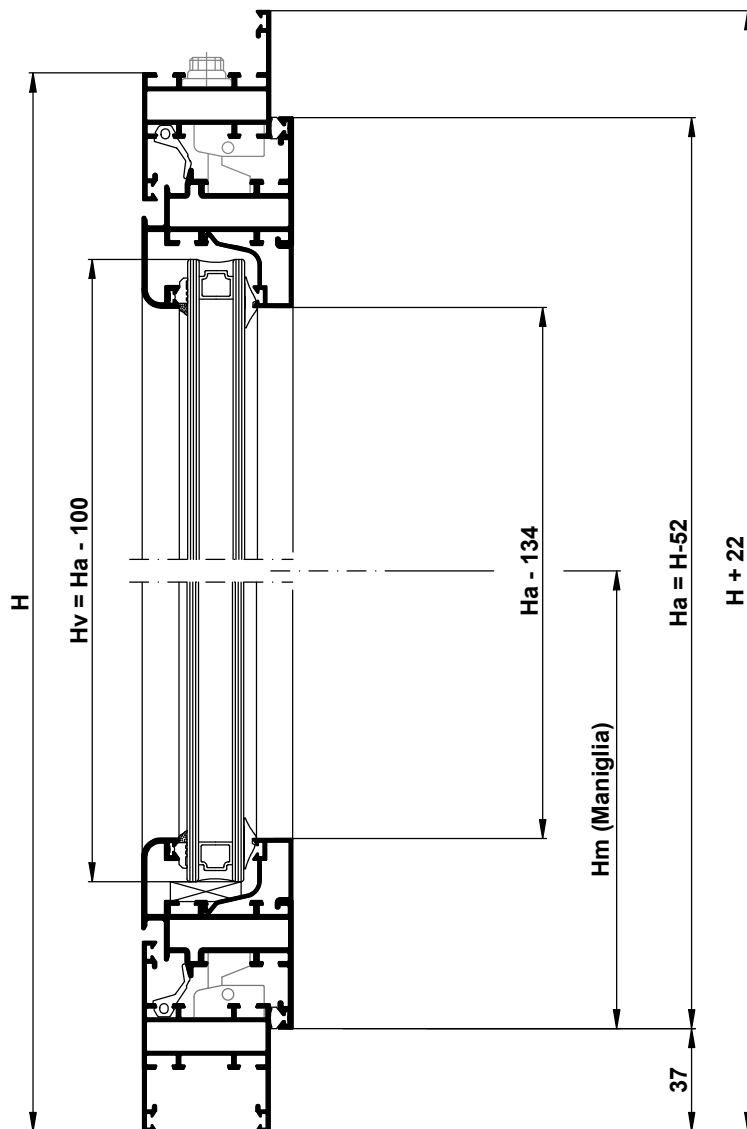

FINESTRA A 2 ANTE

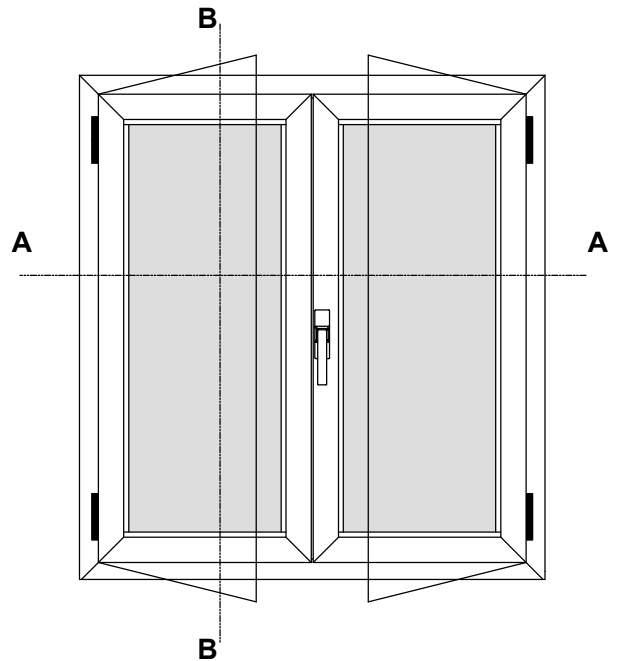

N.B.



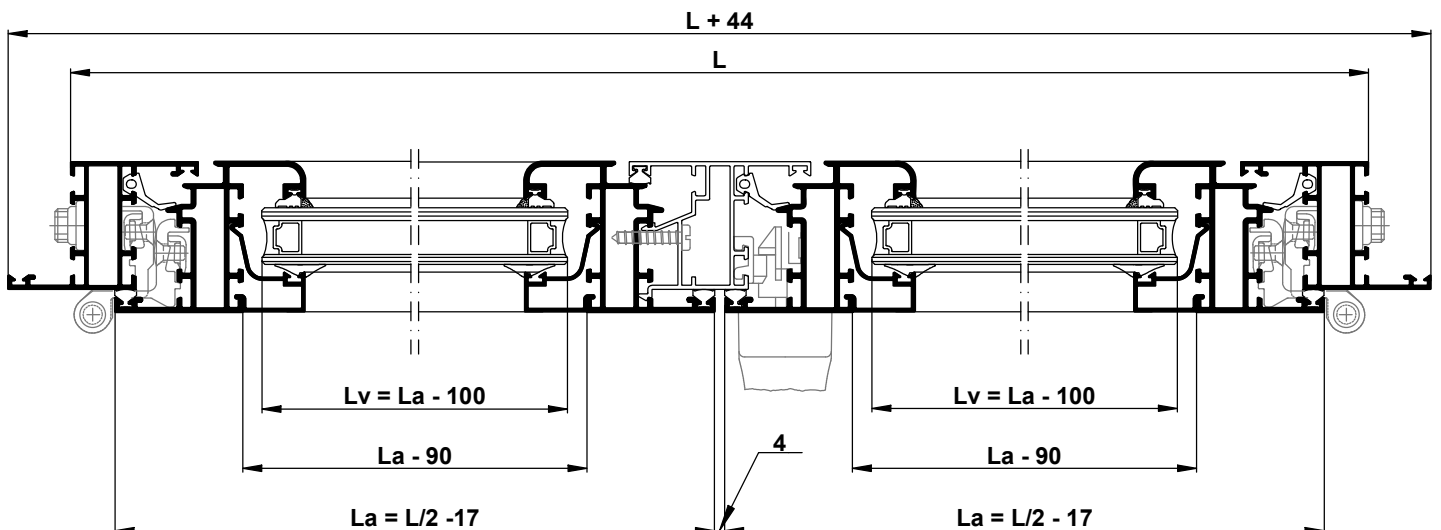

Spessore vetro considerato 20mm

Gioco perimetrale tra profilato in alluminio e vetro 5 mm

SEZ. A-A

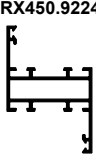
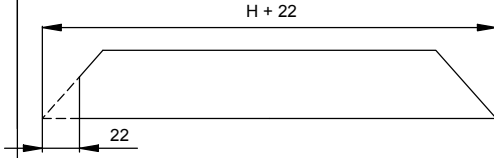
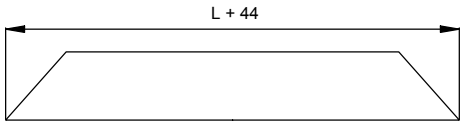
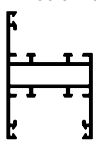
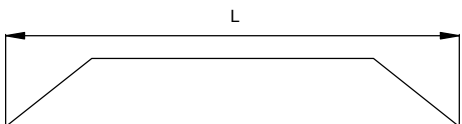
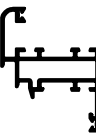
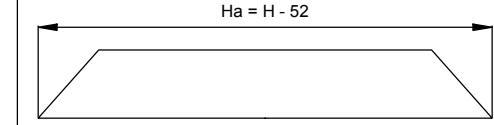
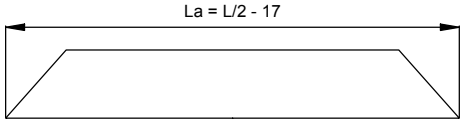
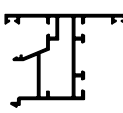
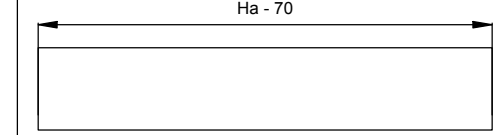

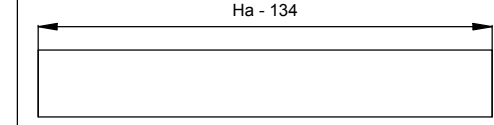
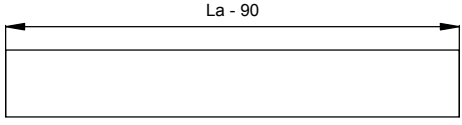

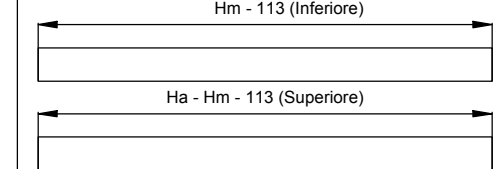
PROFILATO	N.Pz	TAGLIO	N.Pz	TAGLIO
RX450.9224 	2		1	
RX450.9225 			1	
RX450.9659 	2		4	
RX450.9658 				
RX70.506 	2		4	
RX450.9221 	2			

ACCESSORI

ARTICOLO	DESCRIZIONE	N.	ARTICOLO	DESCRIZIONE	N.	ARTICOLO	DESCRIZIONE	N.
ARX 39.SQ	Squadretta in alluminio estruso inserto unificato	12	ARX 10.SQ	Squadretta d' allineamento in nylon su aletta	14			
ARX 03.35	Manovra per puntali	2	ARX 37.SQ	Squadretta d' allineamento lato esterno anta	8			
ARX 10.16	Coppia innesti cremonese apertura interna	1	ARX 03.06	Cremonese reversibile apertura interna	1			
ARX 10.12	Terminale asta	2	ARX 03.13	Riscontro in nylon con rullino per puntali	2			
ARX 04.35	Coppia tappi in nylon battuta centrale	1	509.261.55	Paratempesta in nylon	3			
ARX 06.07	Basetta regolo mobile	8	ARX 06.09	Regolo mobile L = 20 mm	8			
ARX 10.54	Angolo stampato per guarnizione ARX 10.53	4	ARX 03.15	Riscontro terza chiusura su innesti	1			
ARX 02.01	Cerniera sfilabile	4						

GUARNIZIONI

ARTICOLO	DESCRIZIONE	N.	ARTICOLO	DESCRIZIONE	N.	ARTICOLO	DESCRIZIONE	N.
ARX 10.29	Guarnizione appoggio vetri da 3 mm	4H - 2L	ARX 10.53	Guarnizione per precamera	3H - 2L			
ARX 10.12	Guarnizione su fermavetro spessore 3 mm	4H - 2L	ARX 10.04	Guarnizione di battuta	5H - 2L			

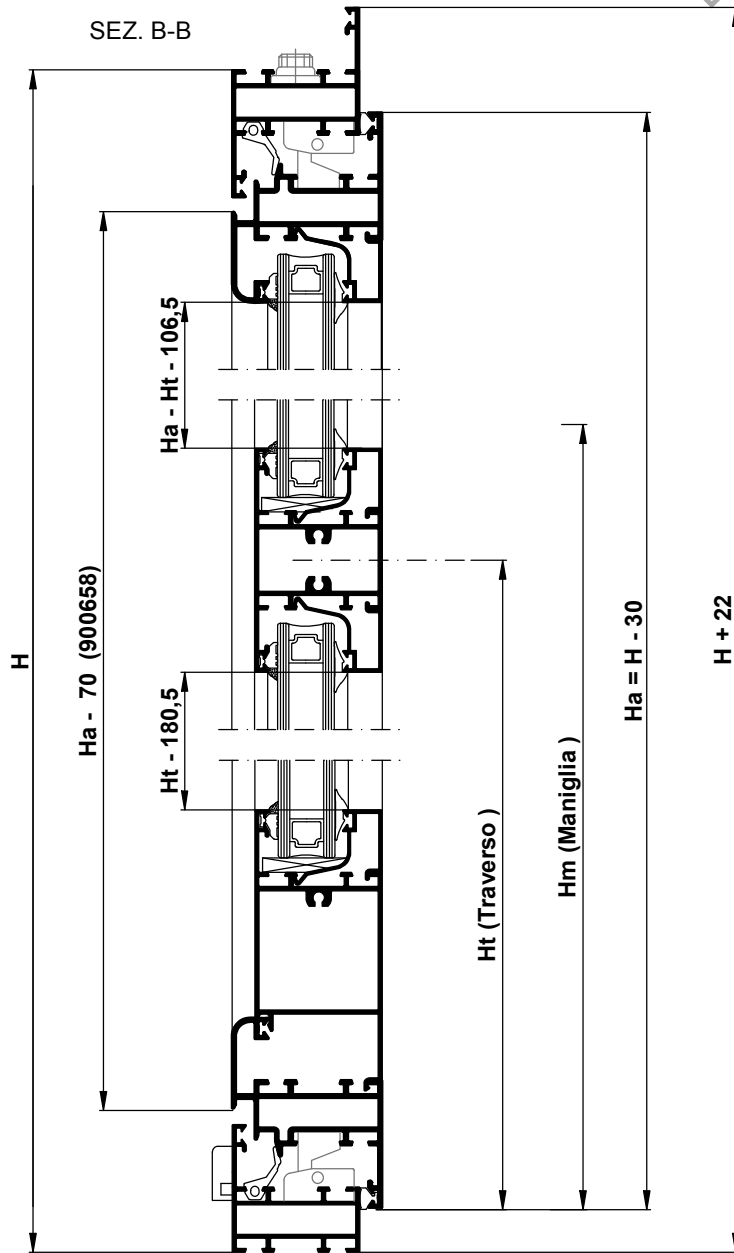



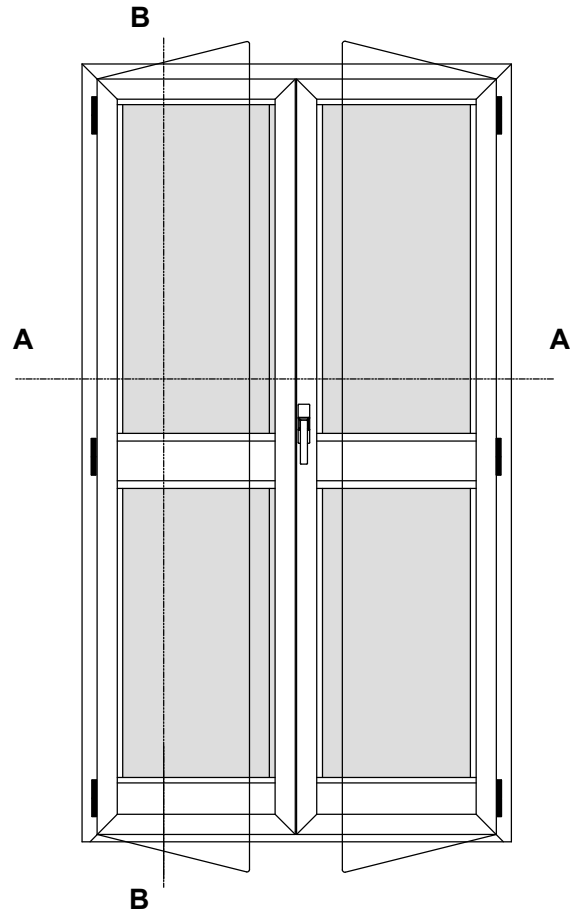

PORTA BALCONE A 2 ANTE

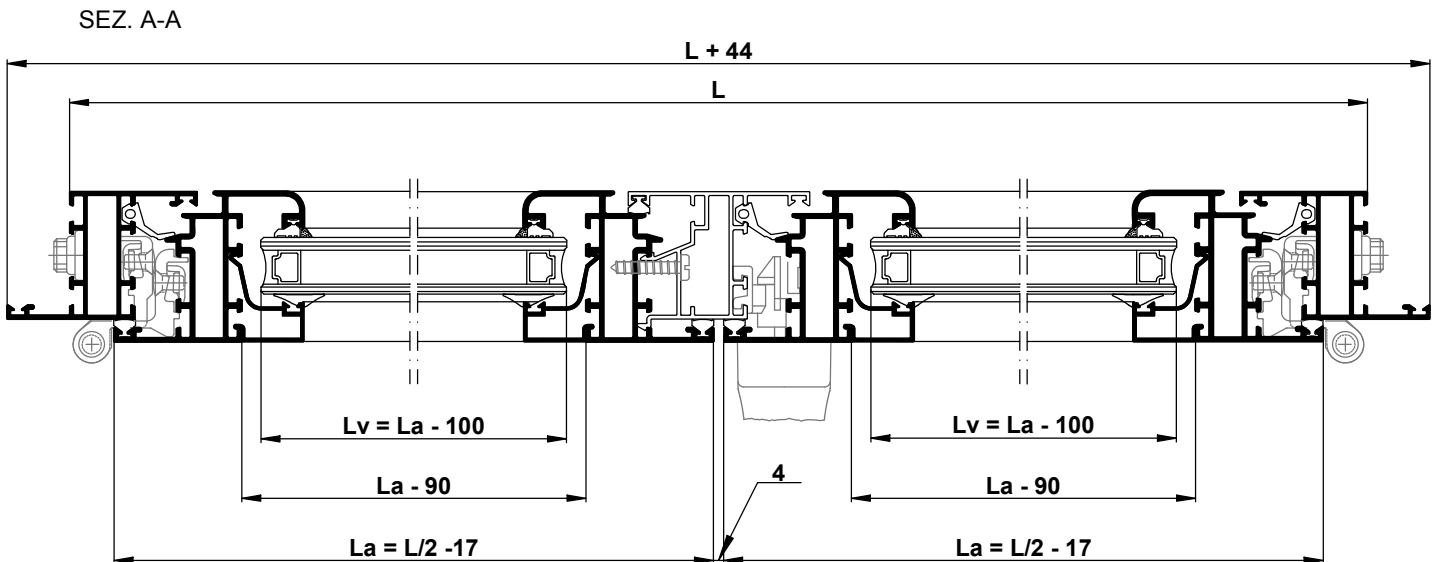

N.B.
Spessore vetro considerato 20mm
Gioco perimetrale tra profilato in alluminio e vetro 5 mm

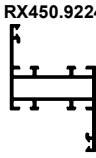
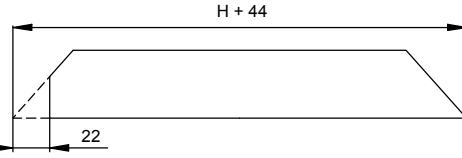
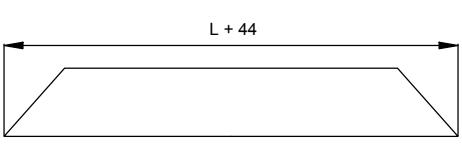
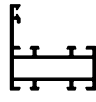
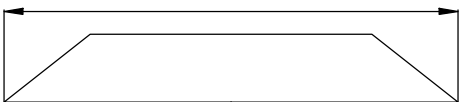
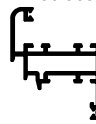
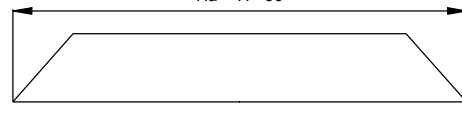
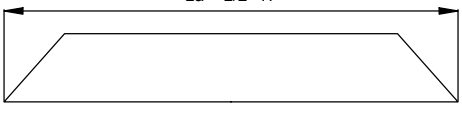
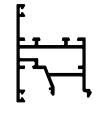
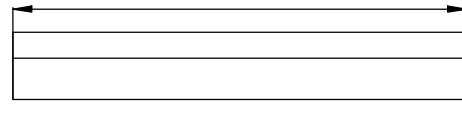

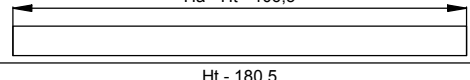
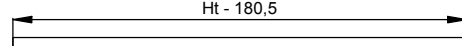
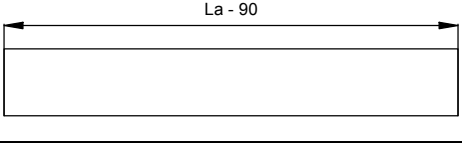

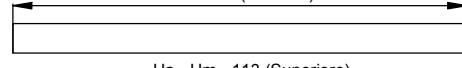
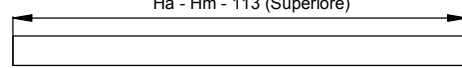
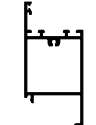
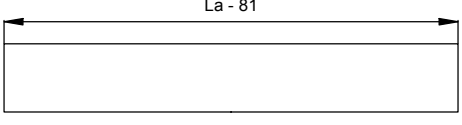
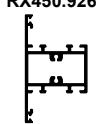
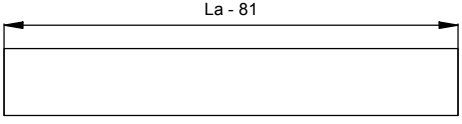
PROFILATO	N.Pz	TAGLIO	N.Pz	TAGLIO
RX450.9224 	2		1	
RX450.9226 			1	
RX450.9659 	4		4	
RX450.9658 	1			
RX70.506 	4 4	 	8	
RX450.9221 	2	 		
RX450.8363 			2	
RX450.9263 			2	

ARTICOLO	DESCRIZIONE	N.	ARTICOLO	DESCRIZIONE	N.	ARTICOLO	DESCRIZIONE	N.
ARX 39.SQ	Squadretta in alluminio estruso inserto unificato	12	ARX 10.SQ	Squadretta d' allineamento in nylon su aletta	14			
ARX 03.35	Manovra per puntali	2	ARX 37.SQ	Squadretta d' allineamento lato esterno anta	8			
ARX 10.16	Coppia innesti cremonese apertura interna	1	ARX 03.6	Cremonese reversibile apertura interna	1			
ARX 10.12	Terminale asta	2	ARX 03.13	Riscontro in nylon con rullino per puntali	2			
ARX 04.35	Coppia tappi in nylon battuta centrale	1	509.261.55	Paratempesta in nylon	3			
ARX 06.07	Basetta regolo mobile	10	ARX 06.09	Regolo mobile L = 20 mm	10			
ARX 10.54	Angolo stampato per guarnizione ARX 10.53	4	ARX 03.15	Riscontro terza chiusura su innesti	1			
ARX 02.01	Cerniera sfilabile	4						

GUARNIZIONI

ARTICOLO	DESCRIZIONE	N.	ARTICOLO	DESCRIZIONE	N.	ARTICOLO	DESCRIZIONE	N.
ARX 10.29	Guarnizione appoggio vetri da 3 mm	4H - 2L	ARX 10.53	Guarnizione per precamera	3H - 2L			
ARX 10.12	Guarnizione su fermavetro spessore 3 mm	4H - 2L	ARX 10.04	Guarnizione di battuta	5H - 2L			



CENTRO MAZZETTA
con controtelaio

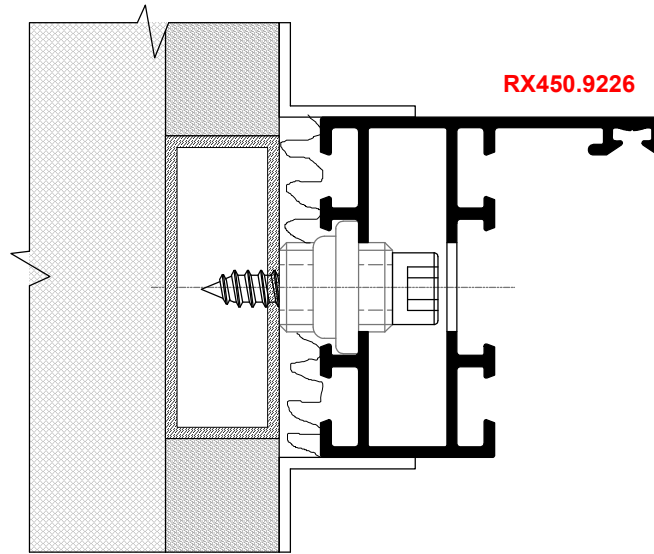

INTERNO
con controtelaio

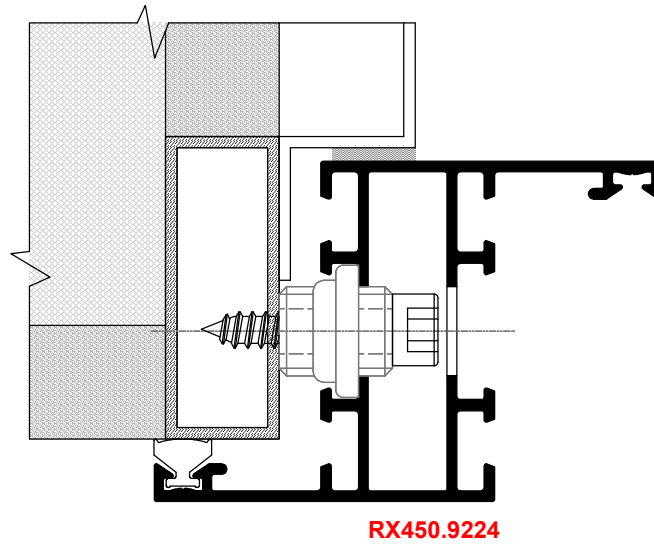

CENTRO MAZZETTA
senza controtelaio

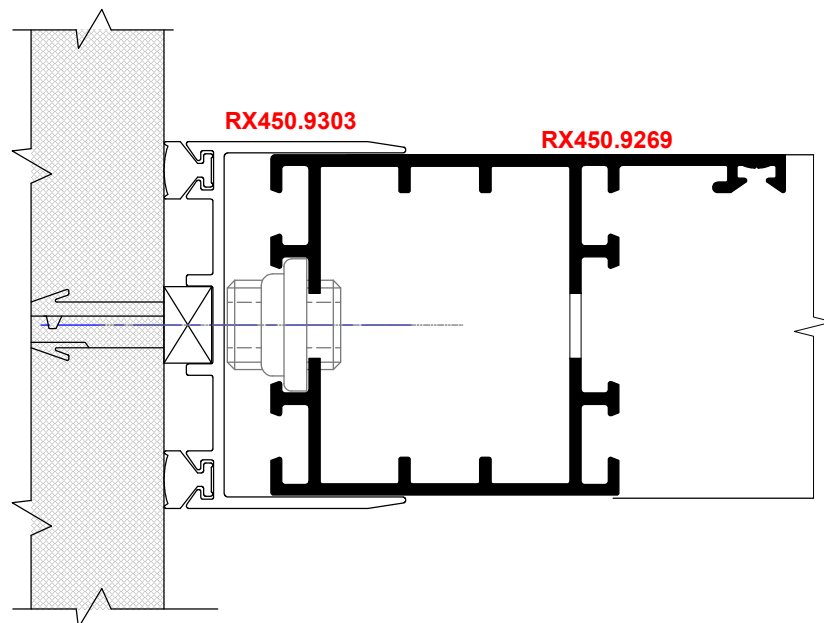



SQUADRETTA ARX 26.SQ

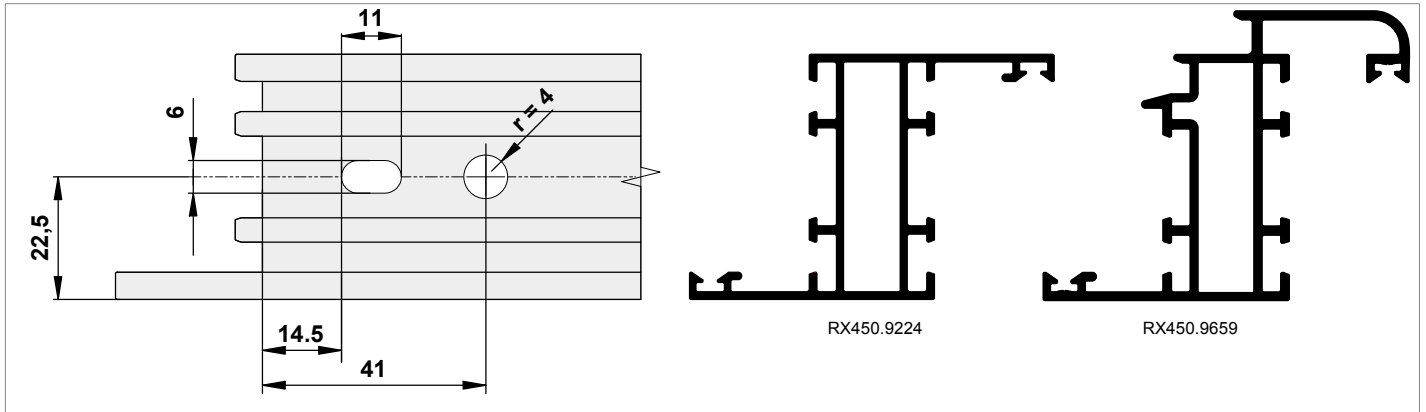

SQUADRETTA ARX 39.SQ

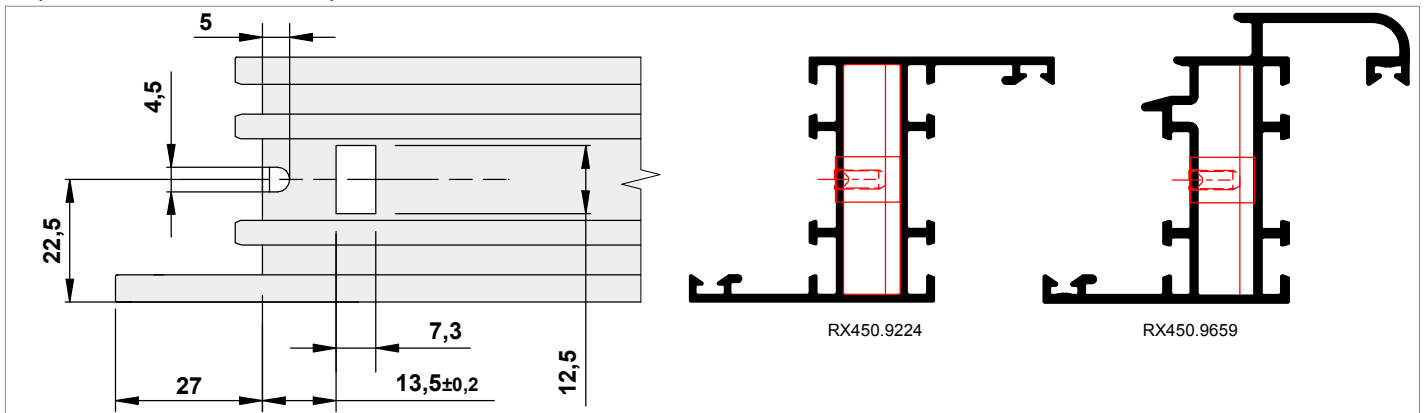

APPLICAZIONE SQUADRETTES DI ALLINEAMENTO ALETTE

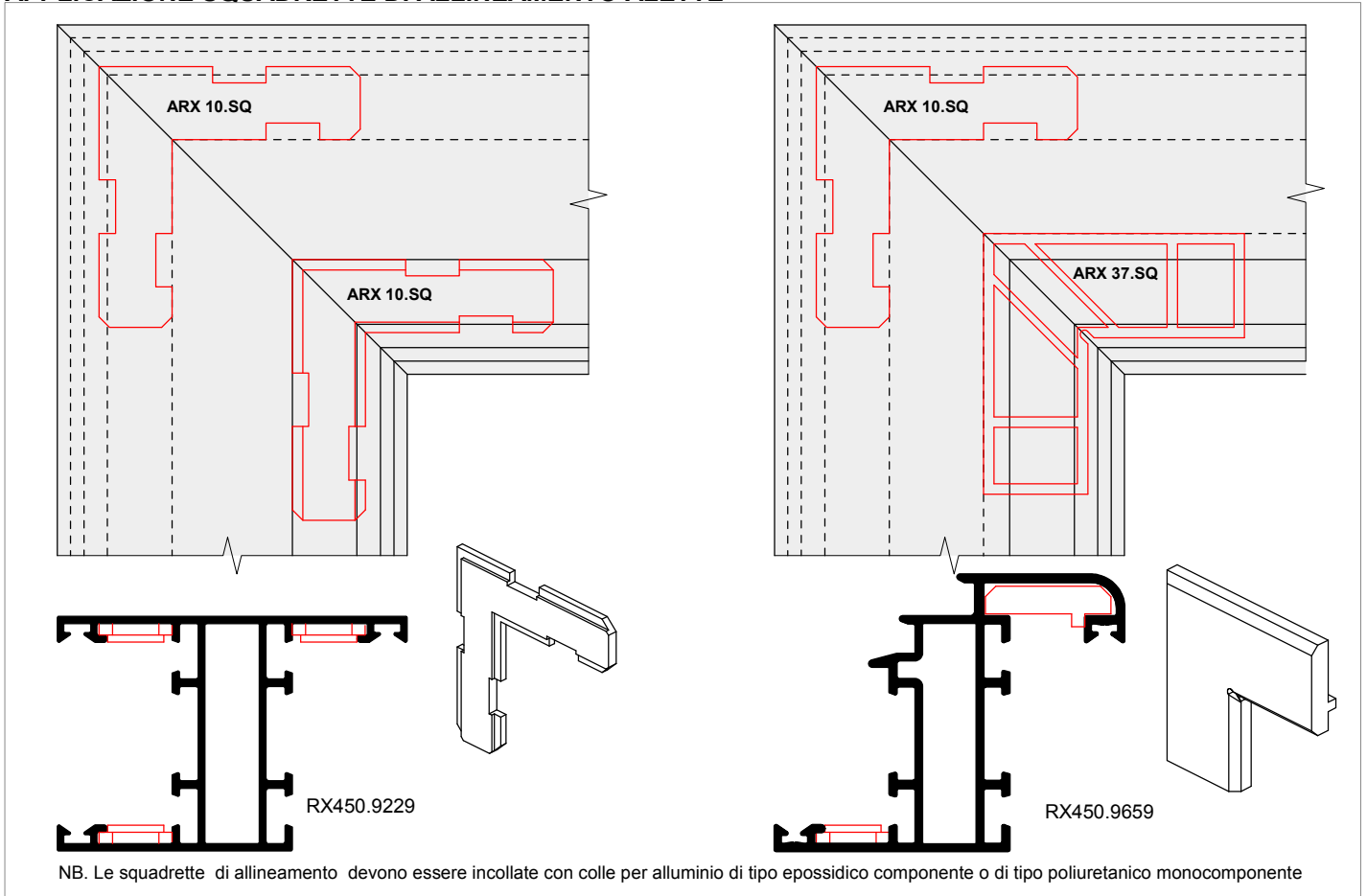

NB. Le squadrette di allineamento devono essere incollate con colle per alluminio di tipo epossidico componente o di tipo poliuretano monocomponente



INTESTATURA FASCE - ZOCCOLI

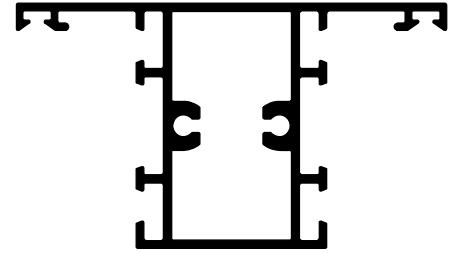
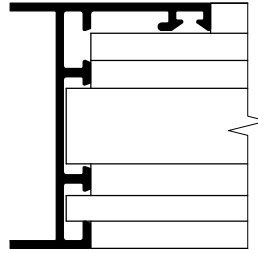
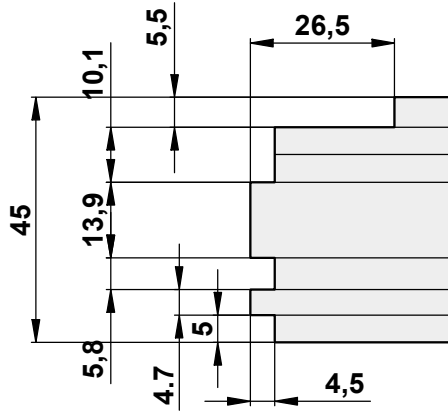

RX450.9263 e Similari

INTESTATURA FASCE - ZOCCOLI

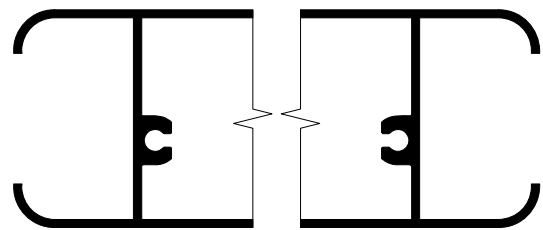
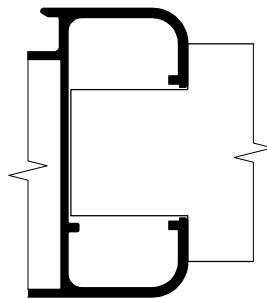
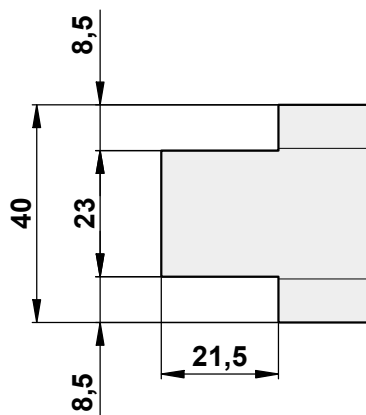

RX450.8326 e Similari



SQUADRETTA ARX 42.SQ

FORATURA PER GIUNTO A "T"

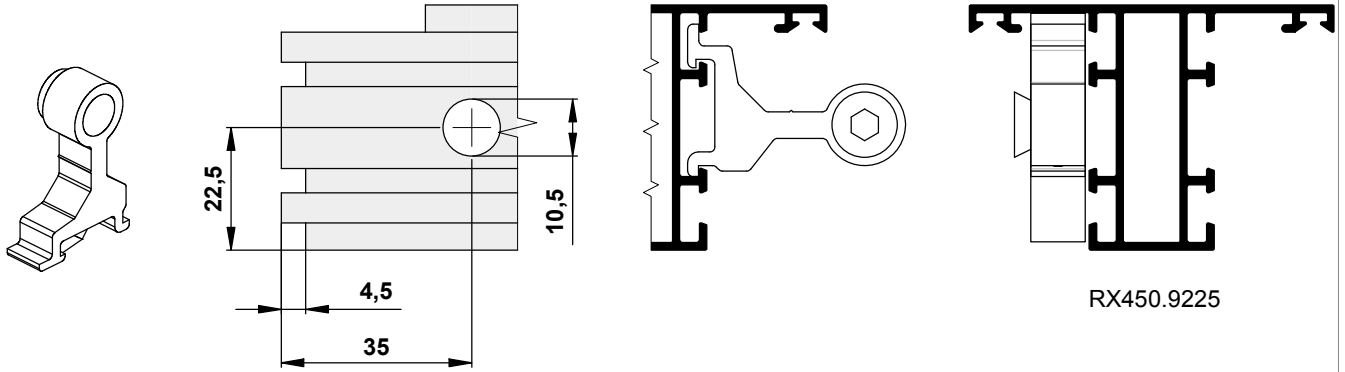

FORATURA SOPRAZOCCOLO E FASCIA (Vetro ad infilare)

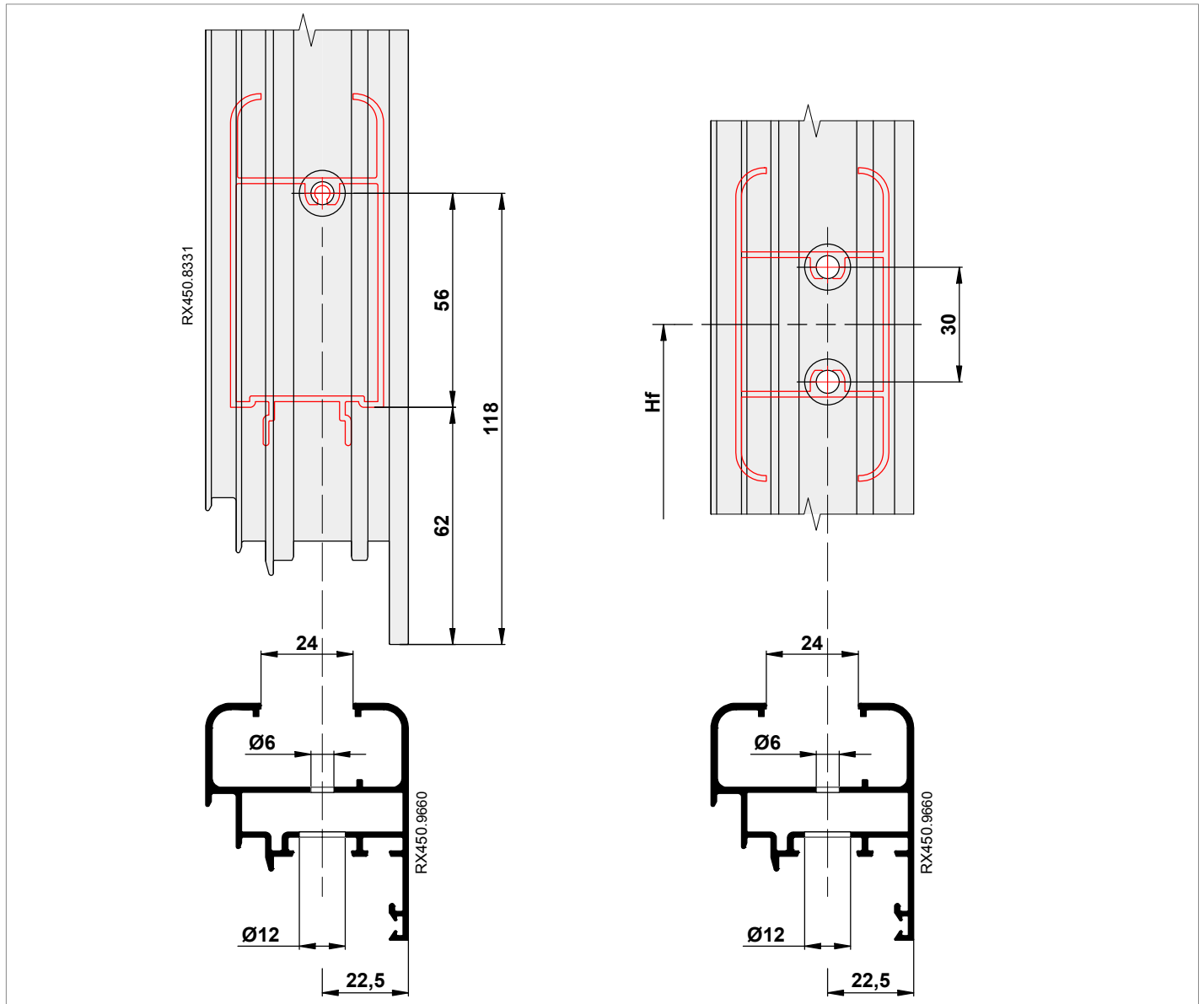



FORATURA SOPRAZOCCOLO E ZOCCOLO PER ANTA

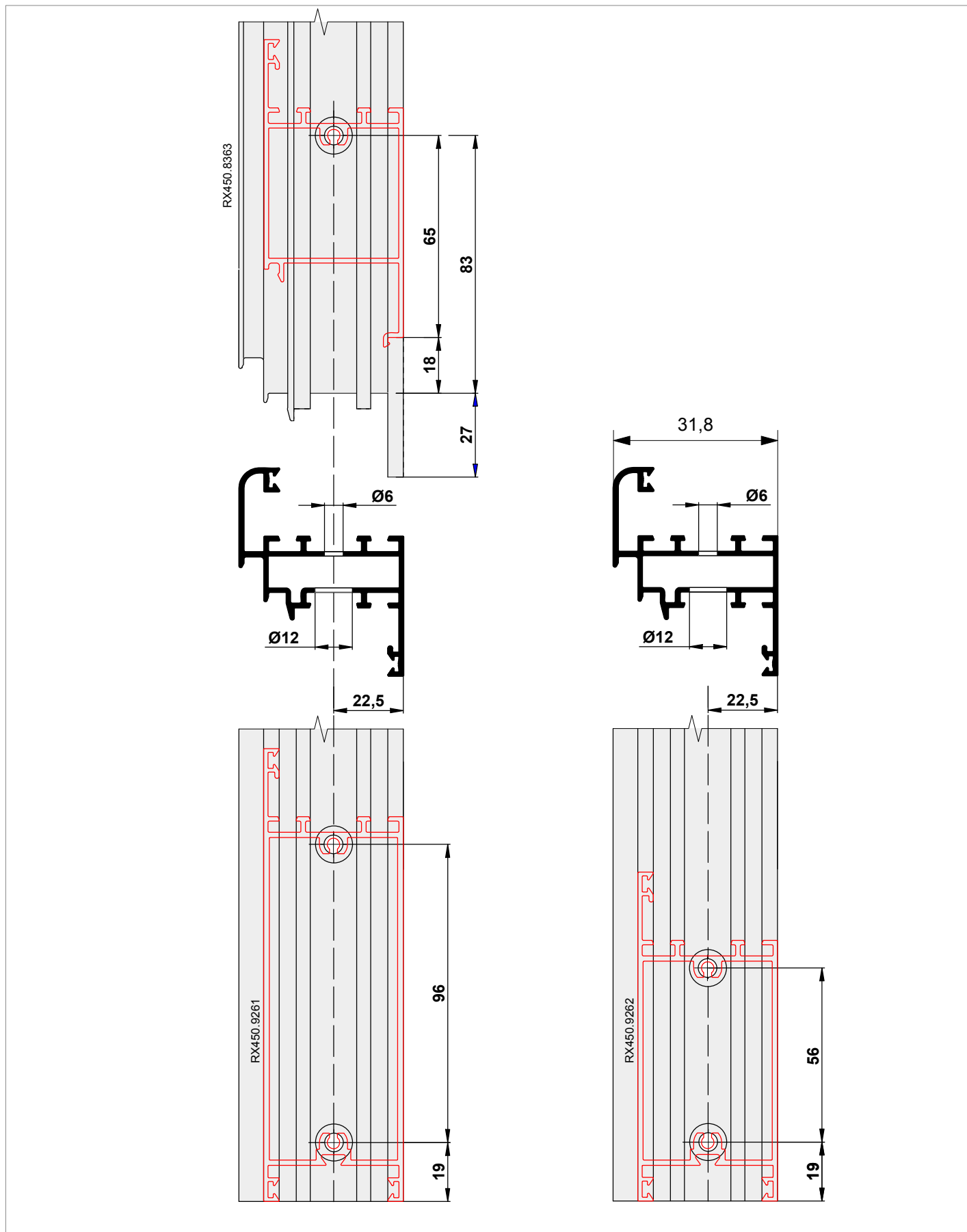



FORATURA FASCIA

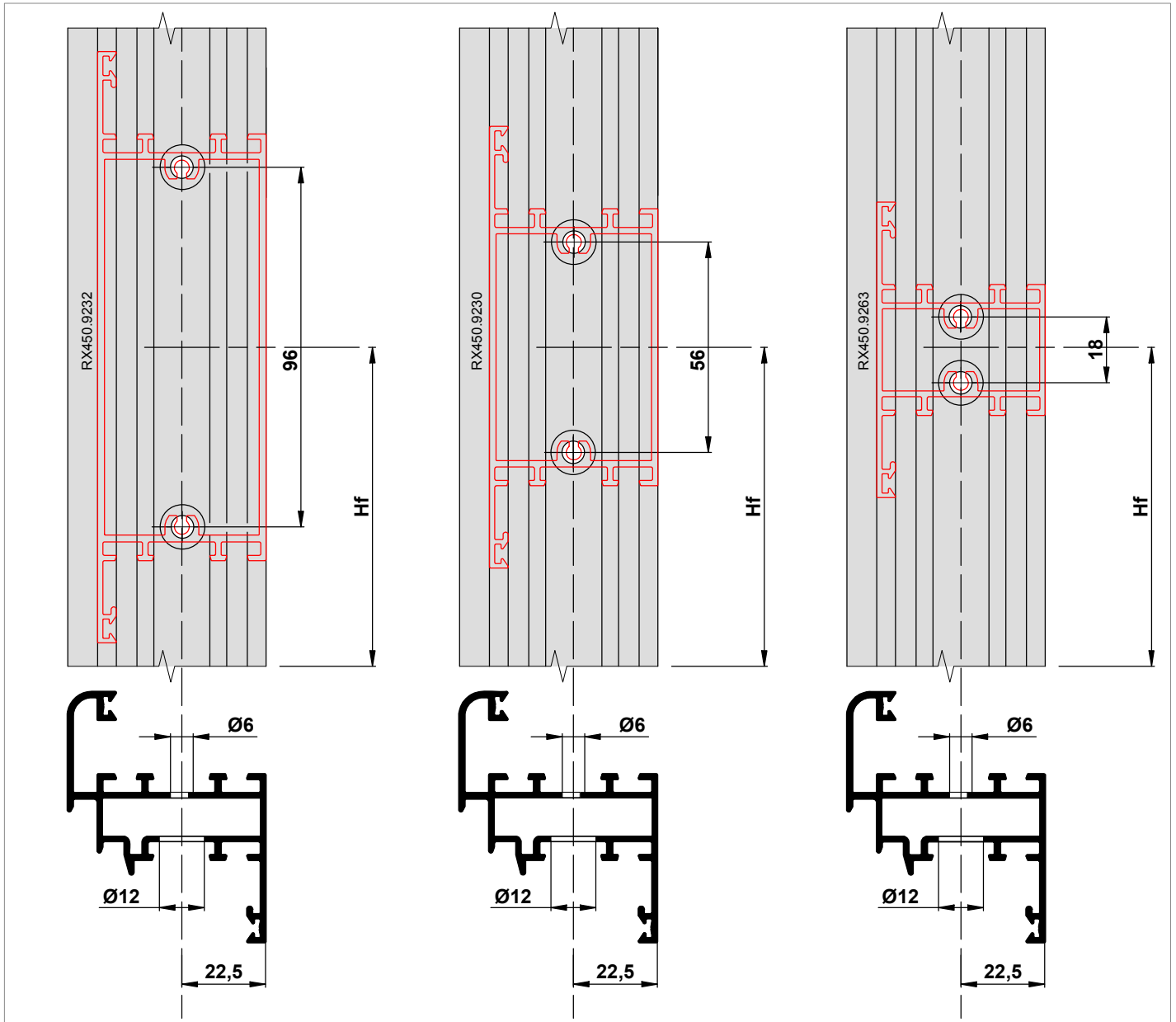

ASPORTAZIONE DENTINI PER INSERIMENTO ASTA

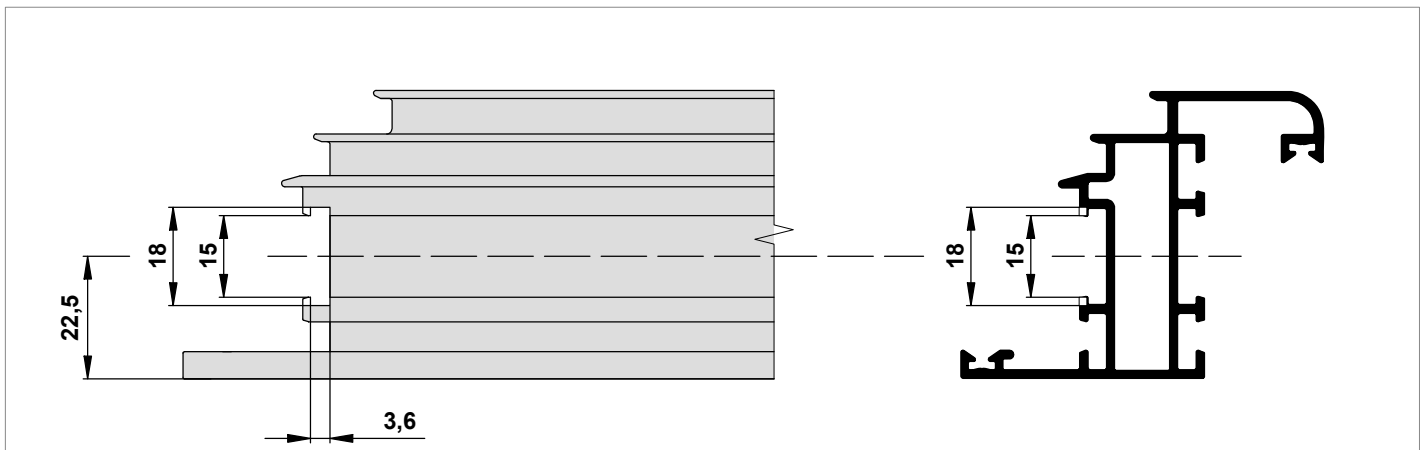



LAVORAZIONE ASTINA

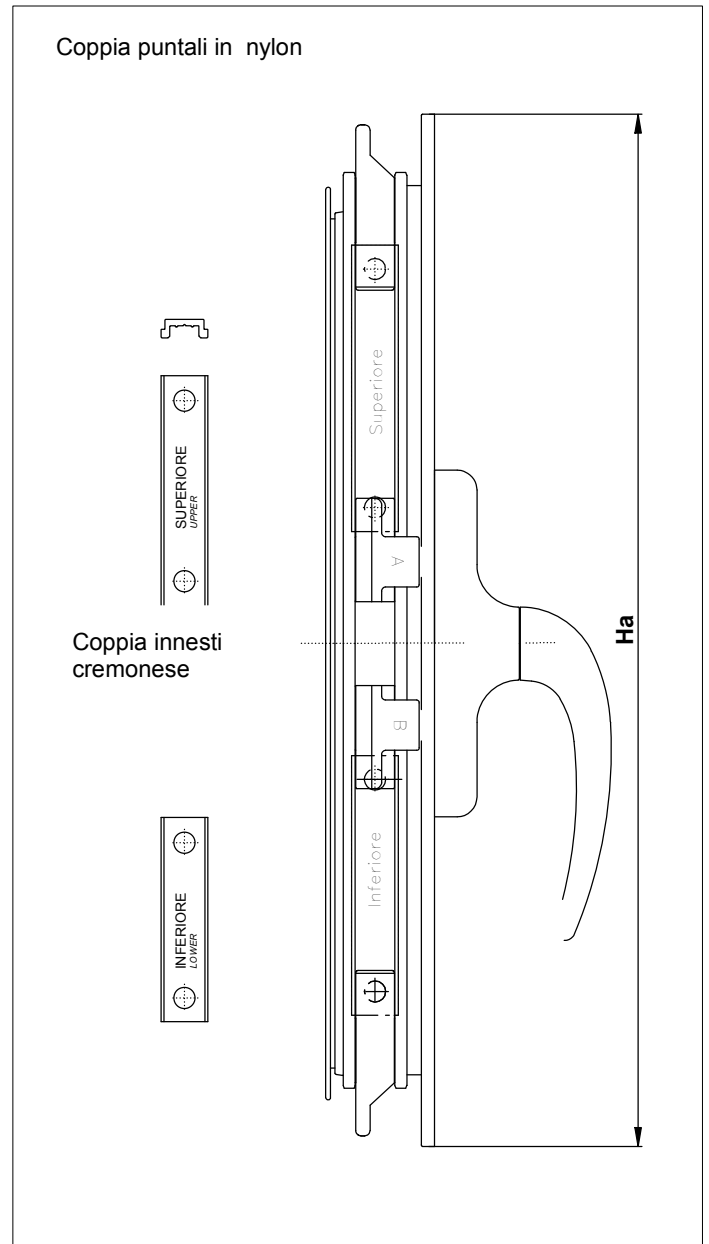
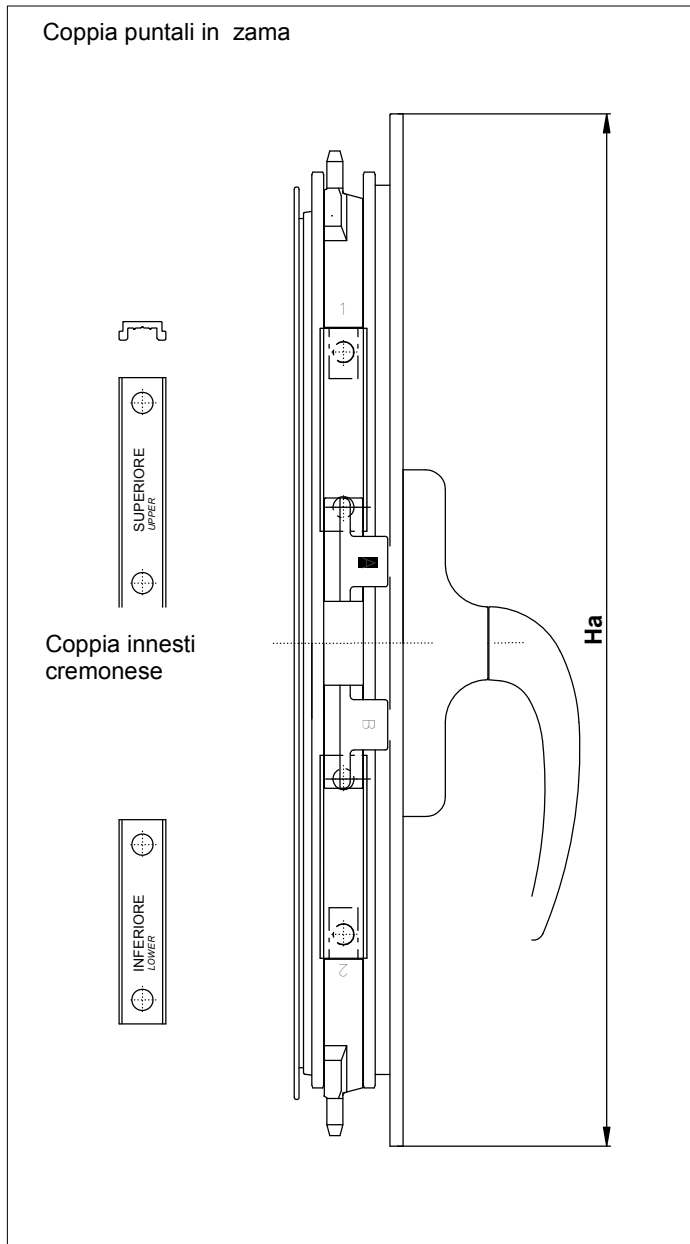

LAVORAZIONE PER CREMONESI

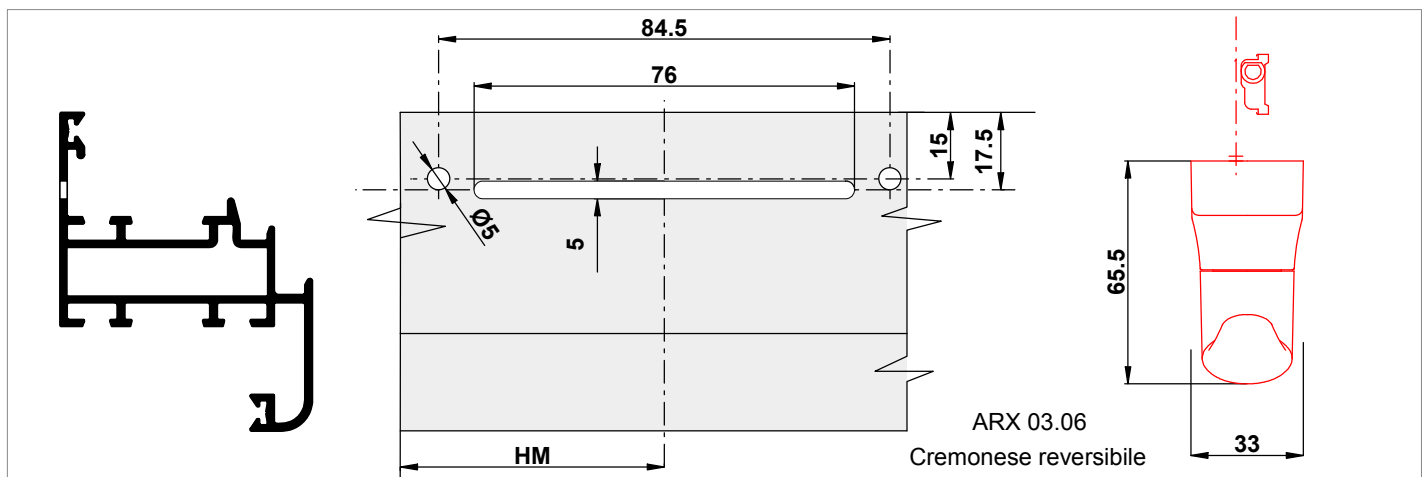



CREMONESE APERTURA ESTERNA

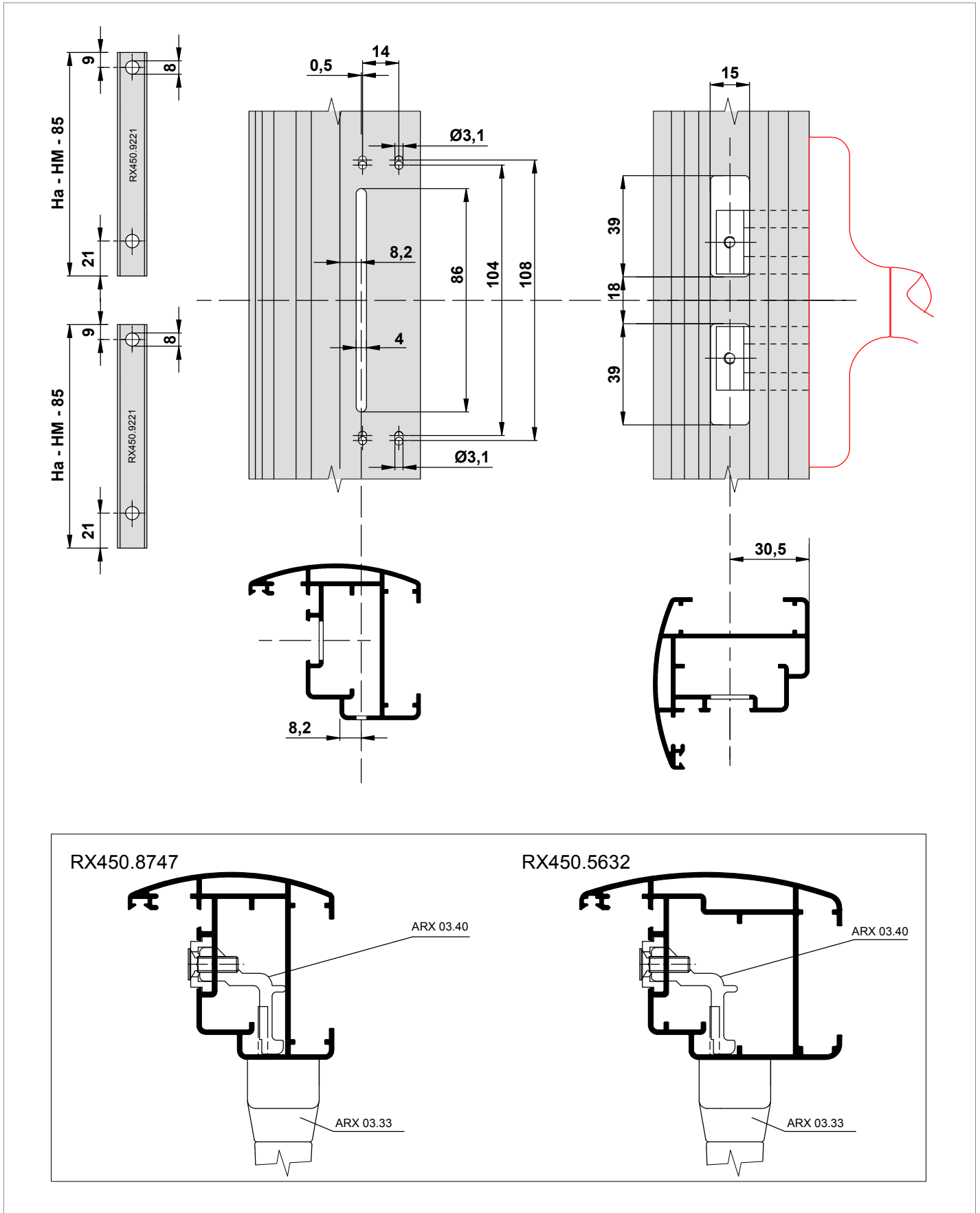



CREMONESE APERTURA ESTERNA

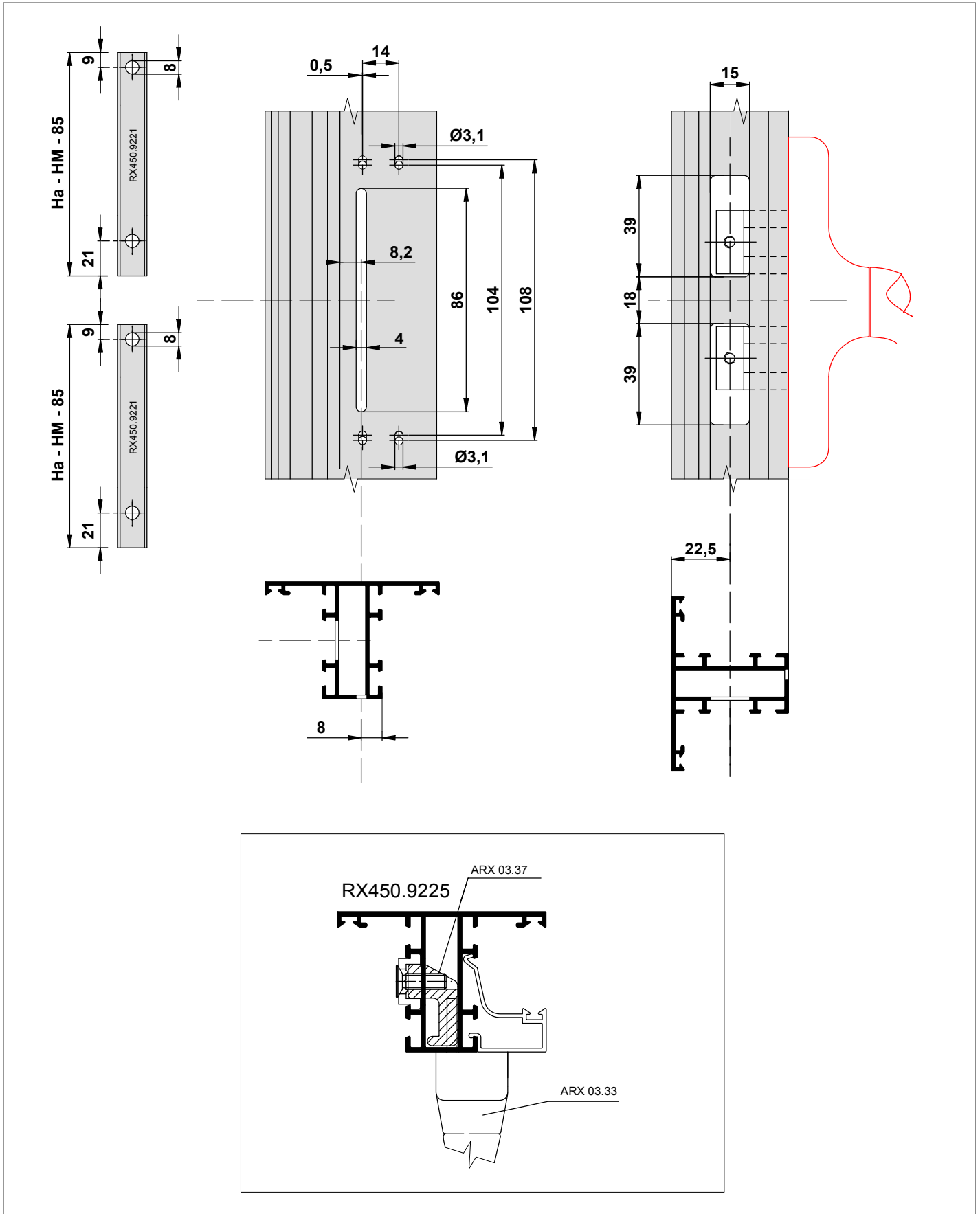

LAVORAZIONE PER SCARICO ACQUA - Articoli 509.260.55 e 509.261.55

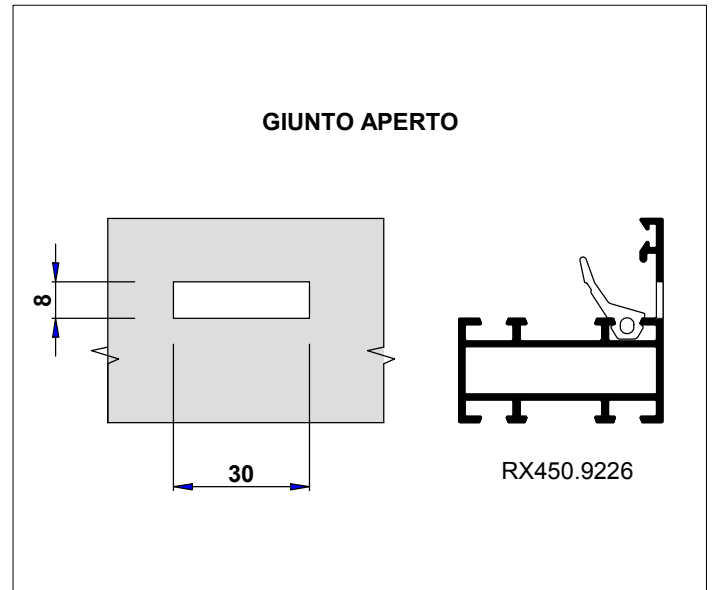
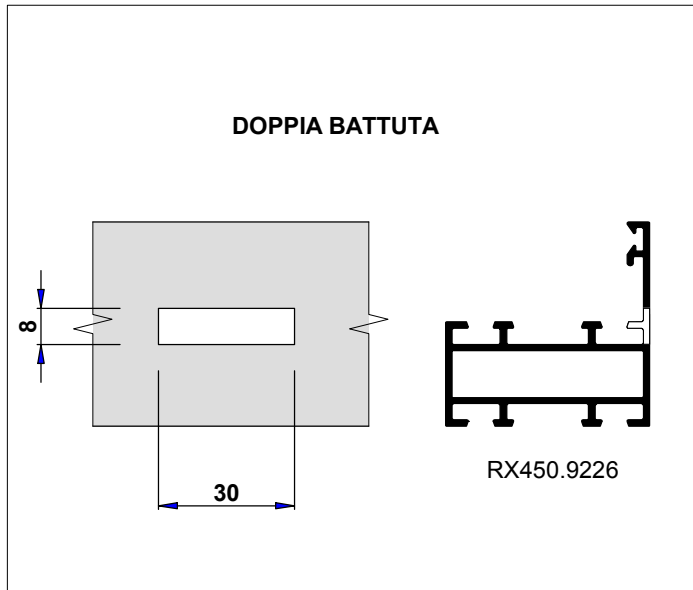

LAVORAZIONE PER SCARICO ACQUA - Articoli 509.265.55

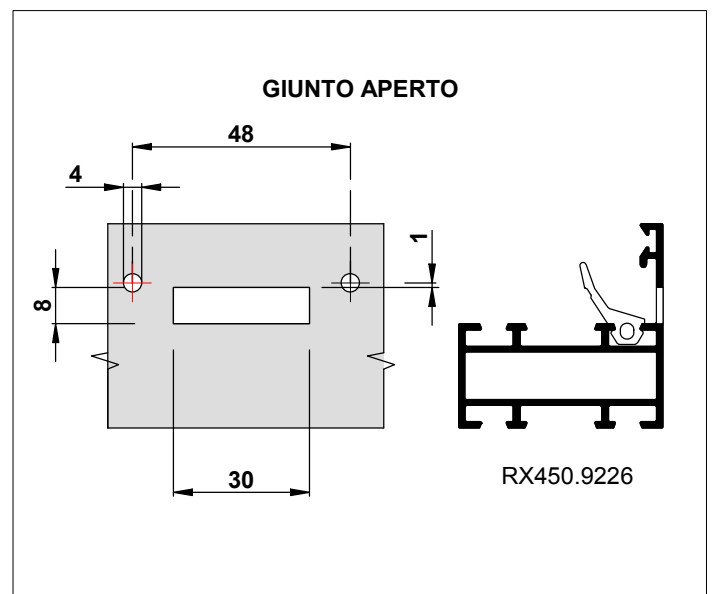
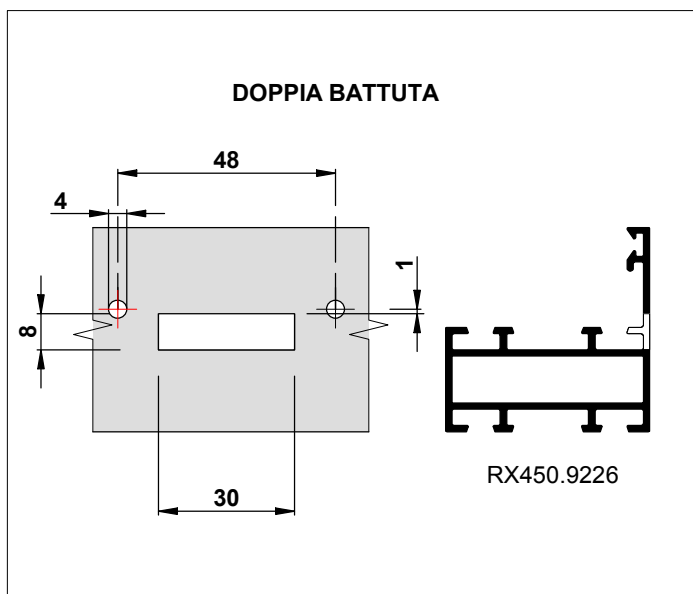

SCHEMA DI MONTAGGIO SPORGERE

GRUPPO ARTICOLAZIONE RINFORZATO PER SPORGERE PORTATA 90 Kg ARX 03.20

I sistemi a sporgere RP40, sono basati sul bilanciamento dell'anta che deve rimanere in equilibrio indipendentemente dalla sua posizione in apertura. Per ottenere le prestazioni ottimali e garantite, il peso dell'anta deve scaricarsi sempre sui bracci e mai sullo scivolo.

Per verificare l'equilibratura dell'anta si può procedere nella seguente maniera: se i bracci sono stati montati troppo in basso l'anta tenderà ad aprirsi autonomamente, viceversa se sono stati montati troppo in alto l'anta tenderà a chiudersi

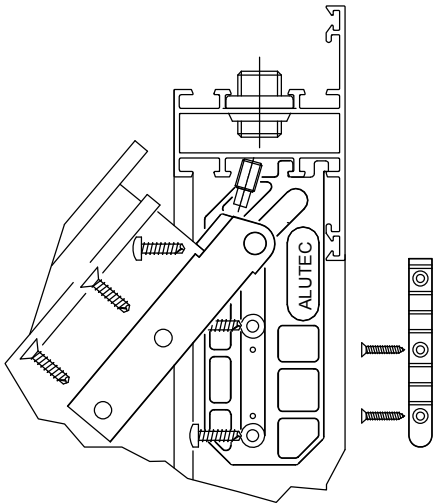

Posizione P	
H anta	P
500	NON FATTIBILE
600	183
700	223
800	265
900	285
1000	300
1100	318
1200	332
1300	342
1400	352
1500	362
1600	370
1700	377
1800	384
1900	392
2000	400

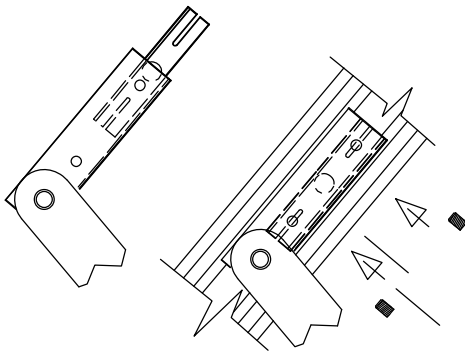

A = Da stabilire in funzione dell'autobilanciamento

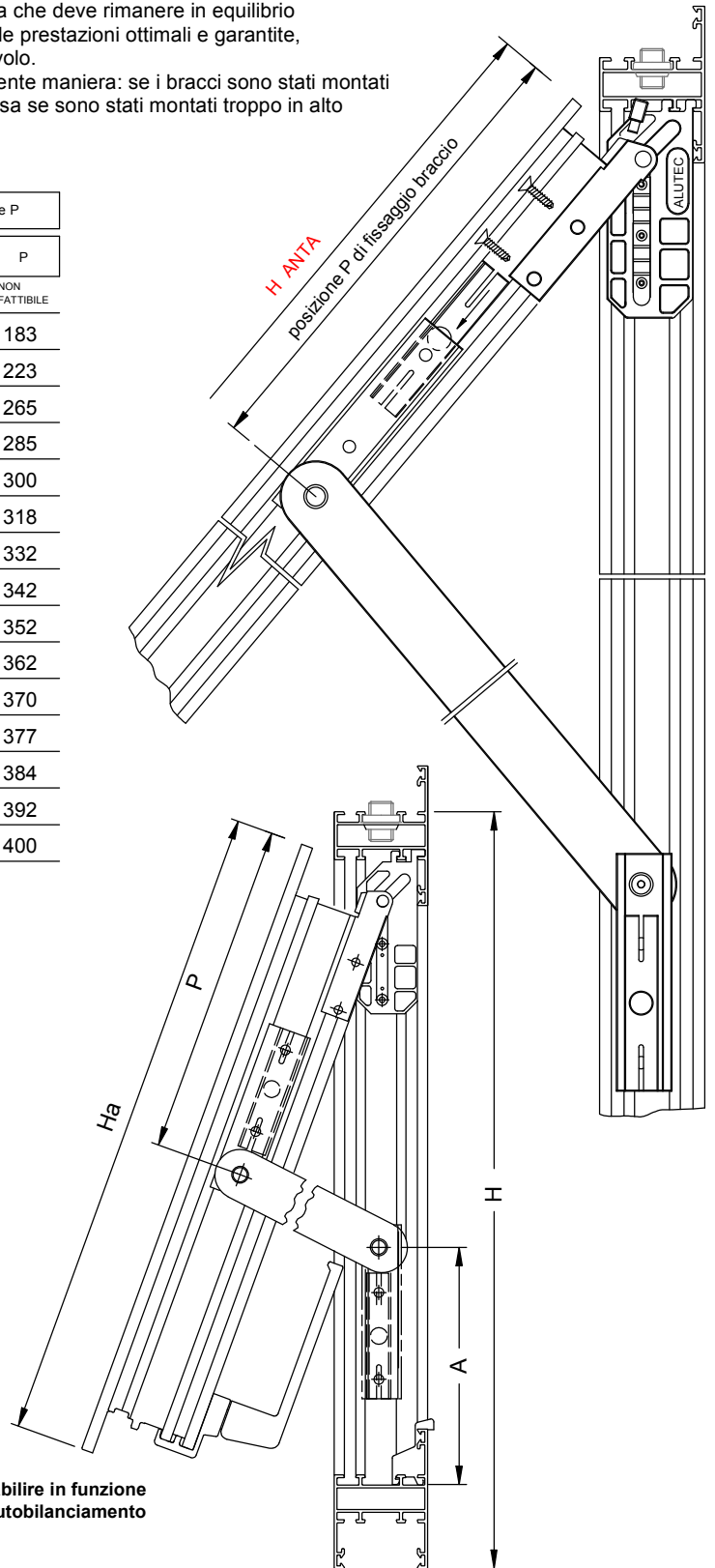

NOTA

Per dimensioni superiori ad L=900 mm applicare n°2 chiusure

Per ulteriori informazioni chiedi lo schema di montaggio 80100057 (Alutec)



APPLICAZIONE ACCESSORI

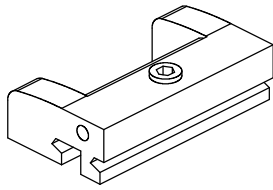

ARX.03.13
Incontro asta doppio

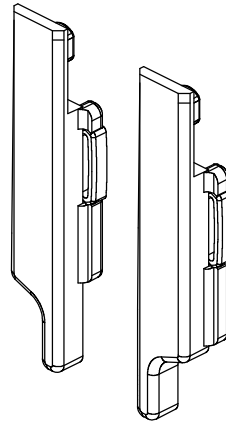
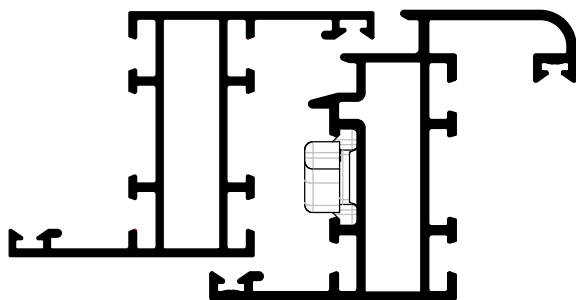

ARX.03.17
Terminali astina

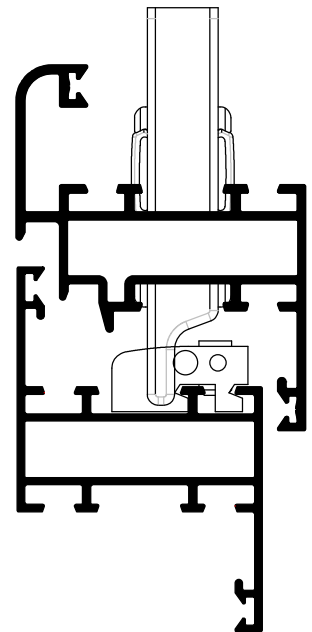

APPLICAZIONE ACCESSORI

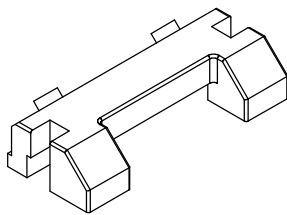

ARX.08.12
Riscontro per anta affiancata

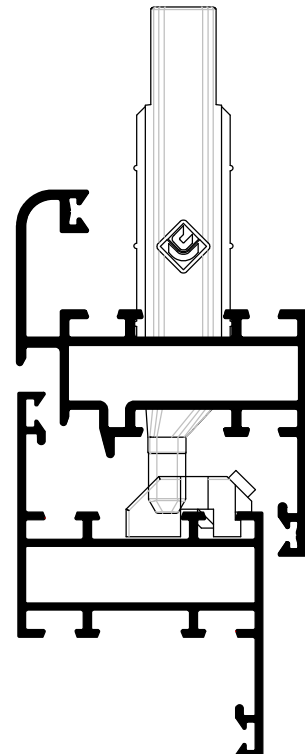
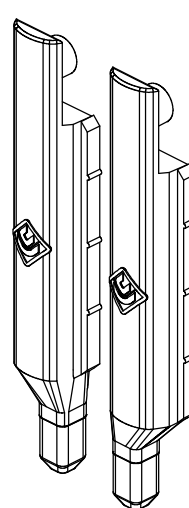
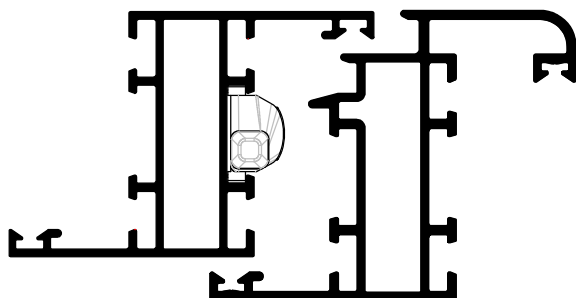

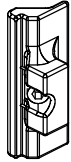
**APPLICAZIONE ACCESSORI**

ARX.03.15
Perno di chiusura
supplementare regolabile

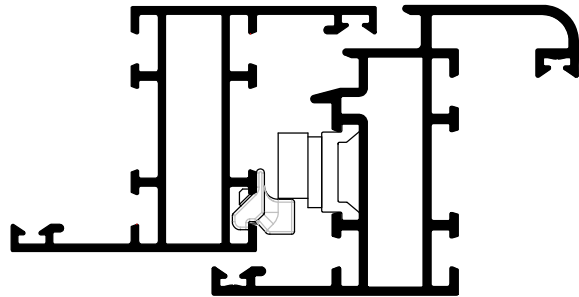
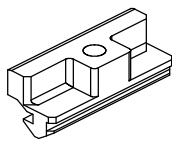
**APPLICAZIONE ACCESSORI**

ARX.03.21
Incontro 3° chiusura su
innesti cremonese

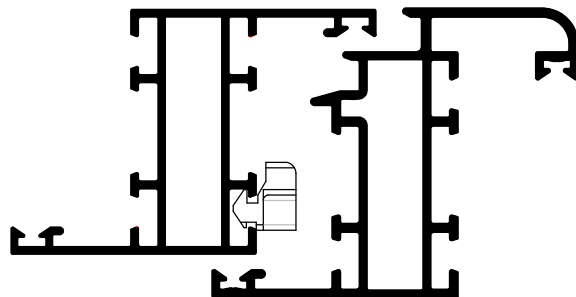

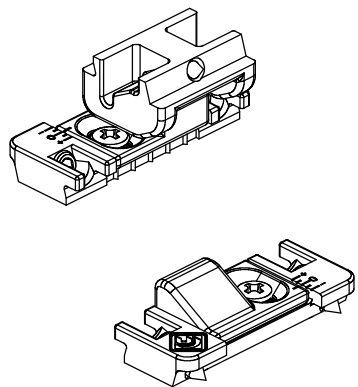
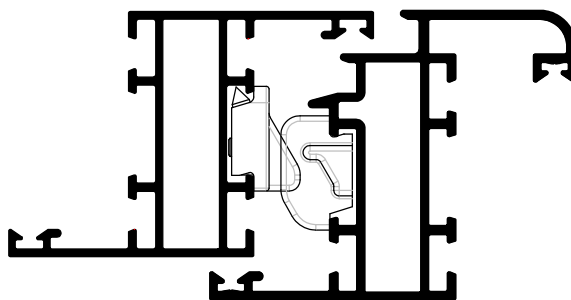
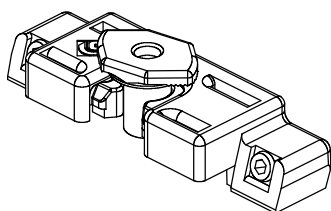
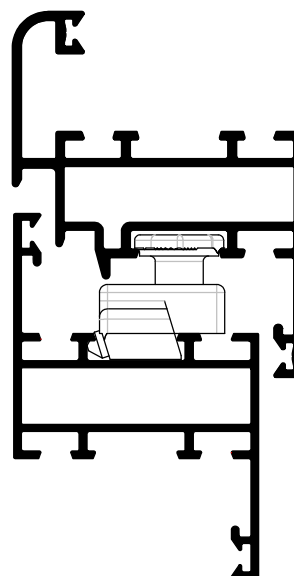
**APPLICAZIONE ACCESSORI****ARX.03.29****Rostro chiusura
supplementare****APPLICAZIONE ACCESSORI****ARX.03.14****Ferma anta**



APPLICAZIONE ACCESSORI

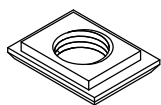

ARX.06.07
Basetta unificata per
regolo mobile



ARX.06.08
Regolo mobile da
mm.15

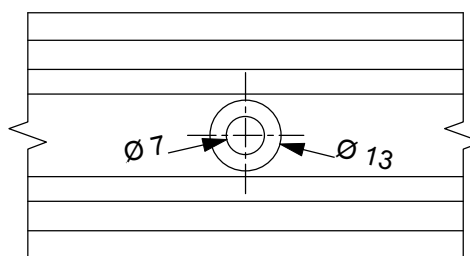
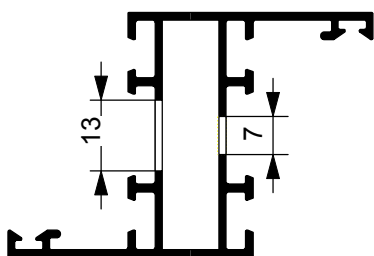
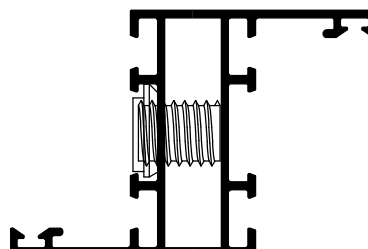

APPLICAZIONE ACCESSORI

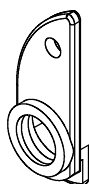

ARX.06.02
Piastrina Registro Universale



ARX.06.08
Regolo mobile da
mm.15

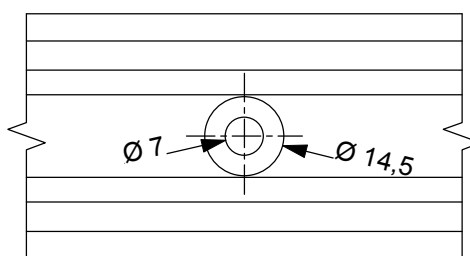
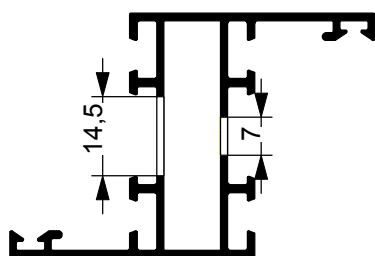
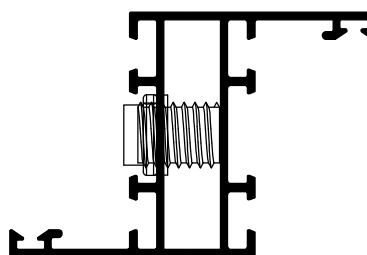



APPLICAZIONE ACCESSORI

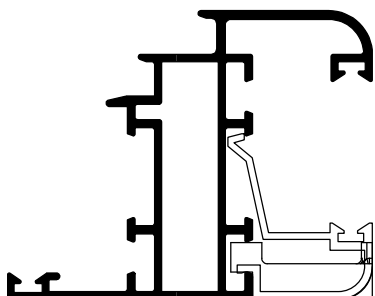
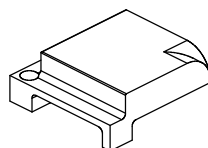
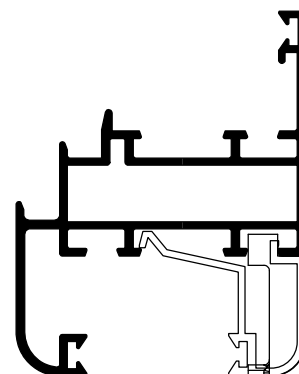
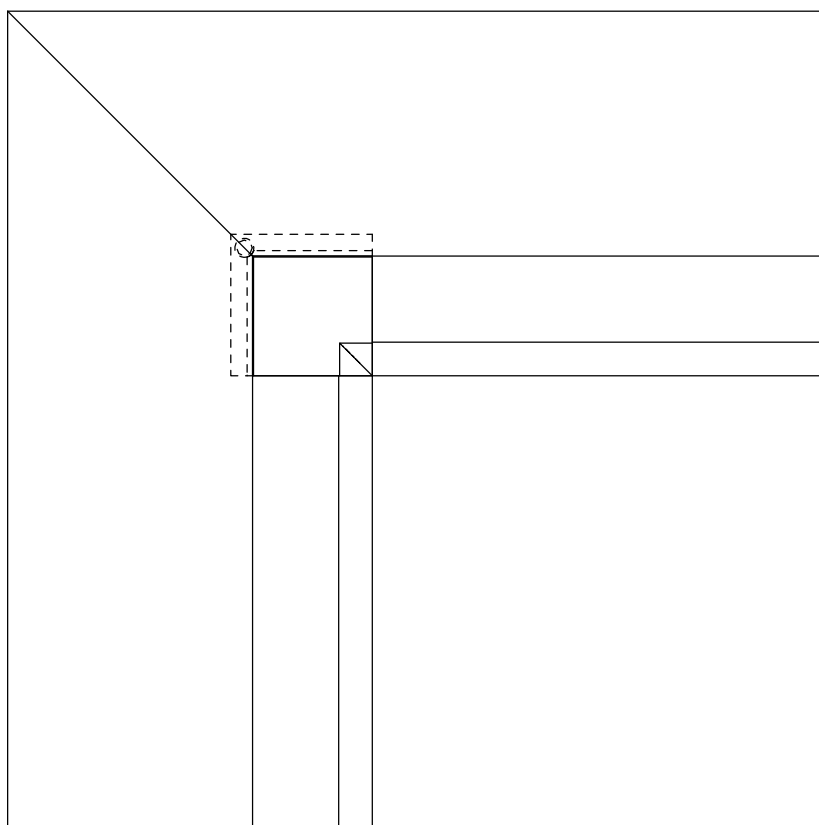

ARX.07.02

Angolo Universale fermavetro

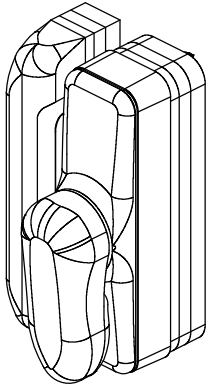
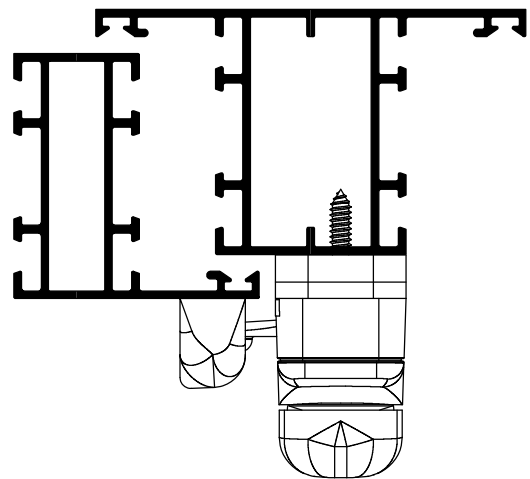
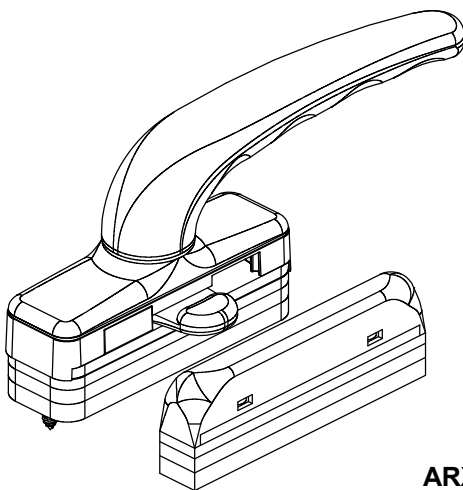
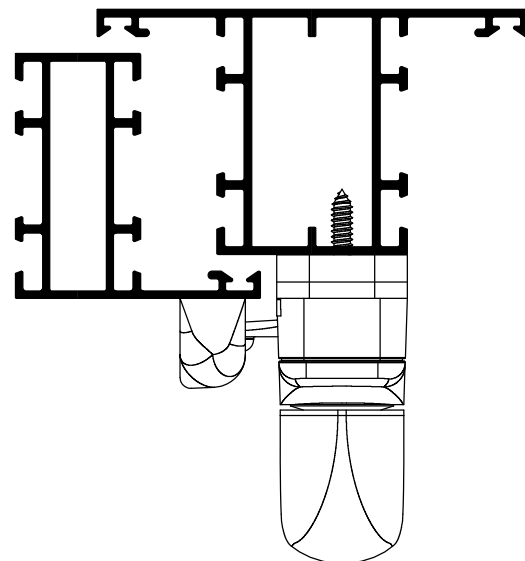
**APPLICAZIONE ACCESSORI****ARX.03.32****Maniglia a tavellino
manico piccolo****APPLICAZIONE ACCESSORI****ARX.03.02****Maniglia a tavellino**



APPLICAZIONE ACCESSORI

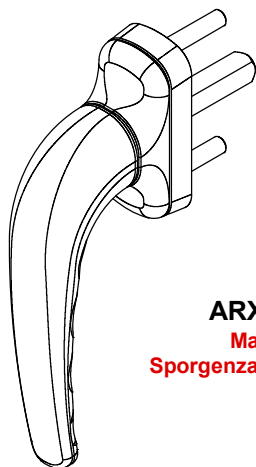

ARX.03.04
Martellina
Sporgenza quadro mm.24

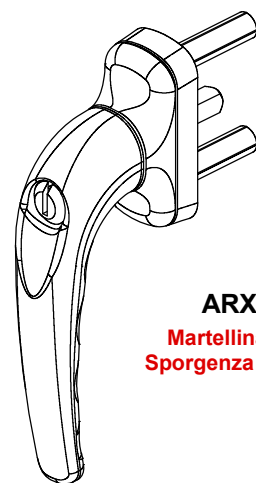
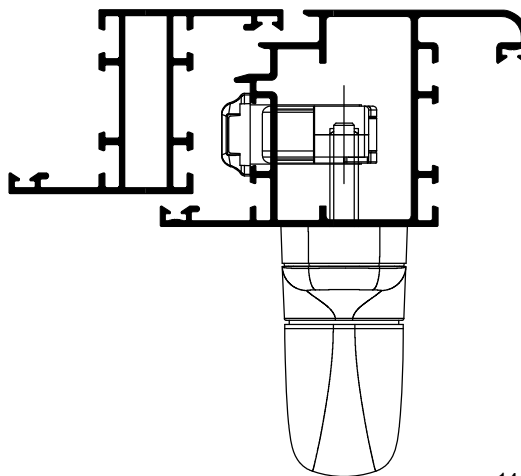

ARX.03.05
Martellina con chiave
Sporgenza quadro mm.24

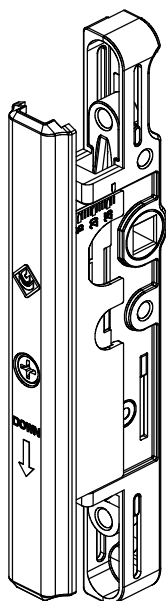
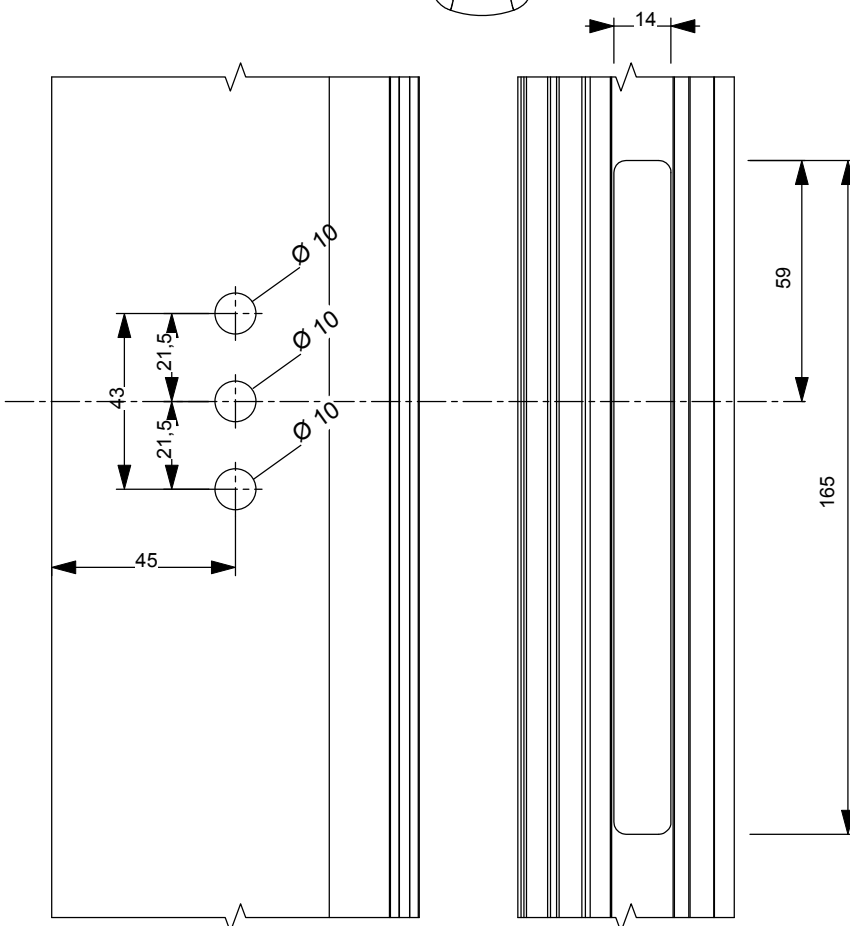

ARX.03.09
Movimentazione Bidirezionale

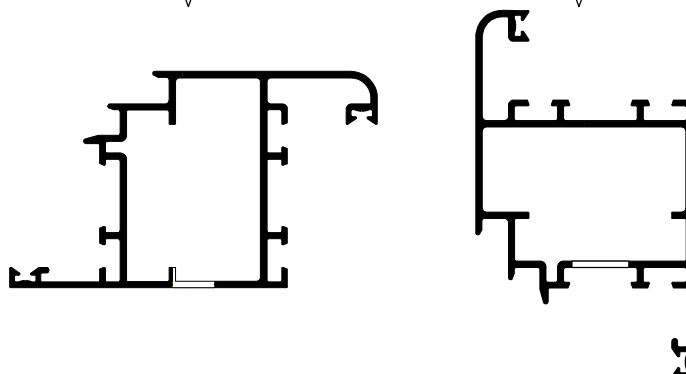



APPLICAZIONE ACCESSORI

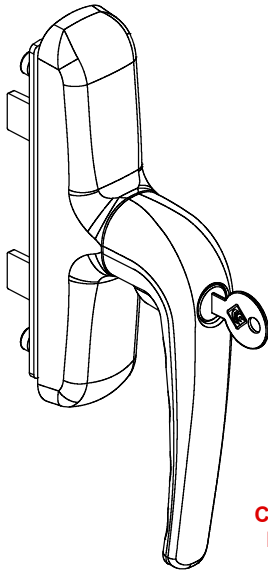

ARX.03.07

Cremonese con chiave
Interasse 84 - 92 - 104

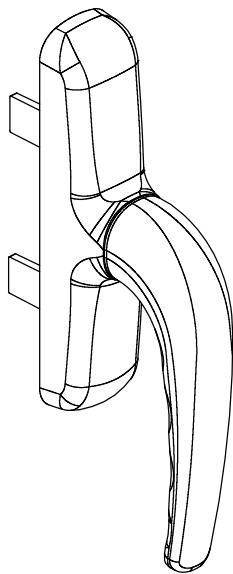
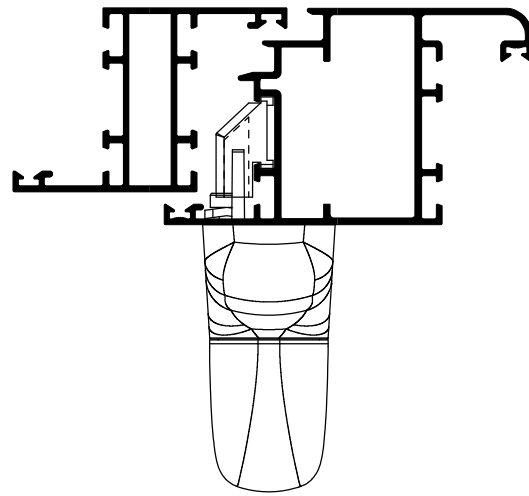

ARX.03.06

Cremonese
Interasse 84 - 92 - 104

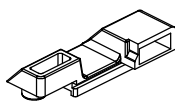
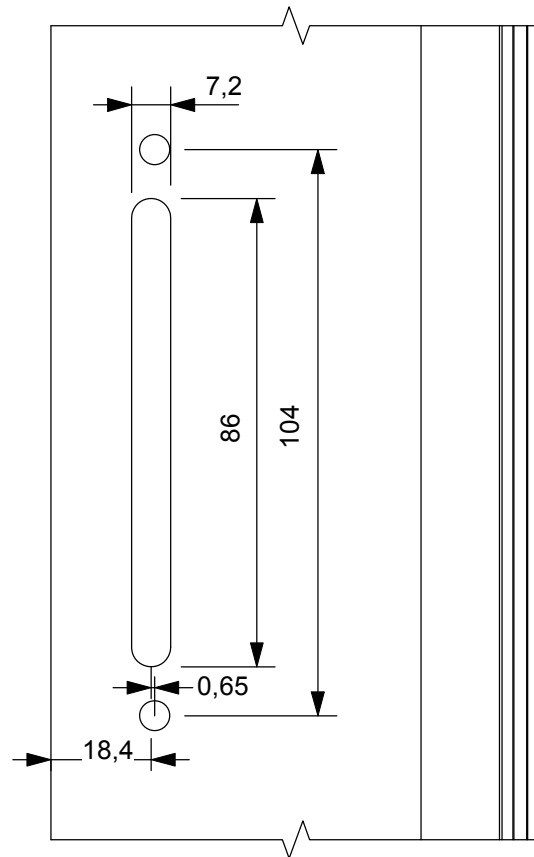

ARX.03.16

Innesti cremonese

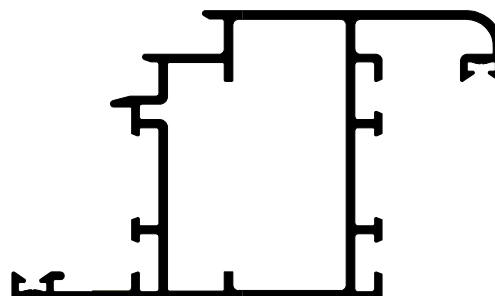



APPLICAZIONE ACCESSORI

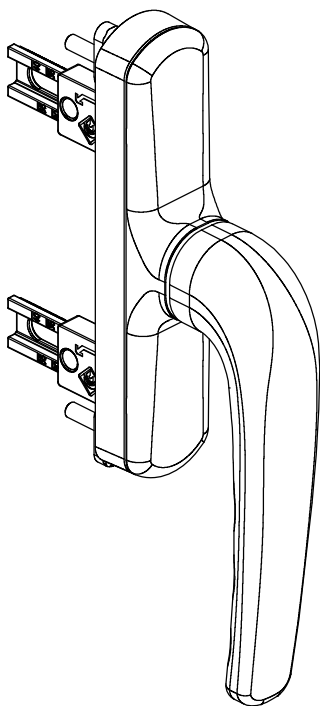
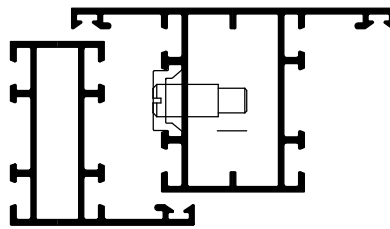

ARX.03.18
Maniglia aperture esterne
(maniglia + cursore)

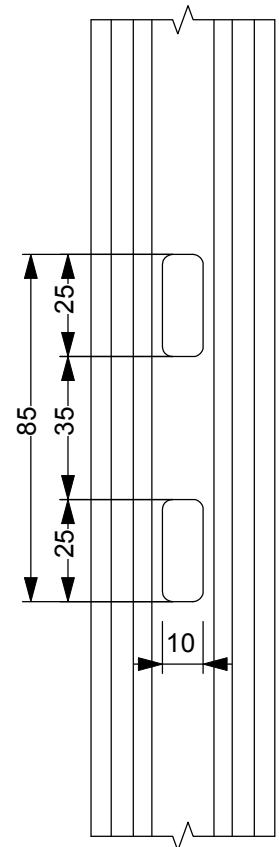
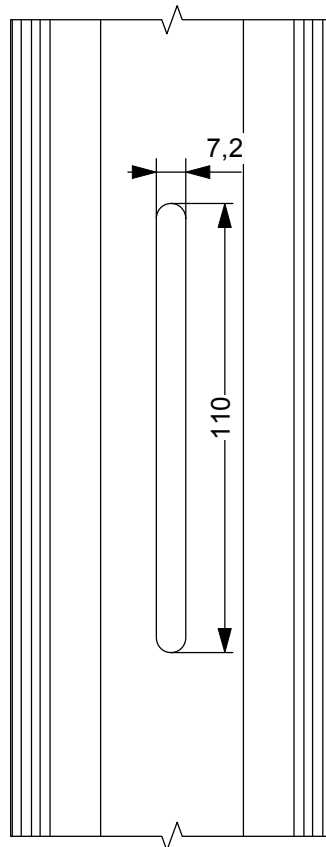

ARX.03.44
Perno di trascinamento L=16mm

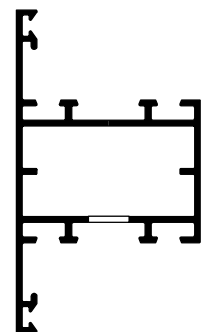
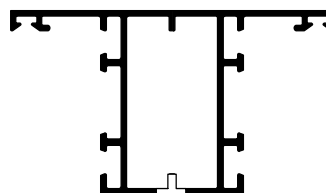



APPLICAZIONE ACCESSORI

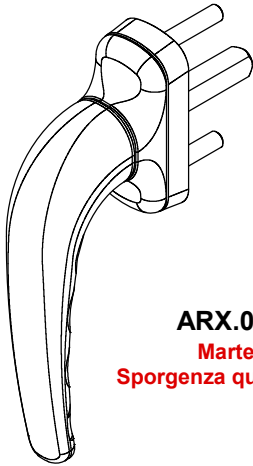

ARX.03.04
Martellina
Sporgenza quadro mm.24

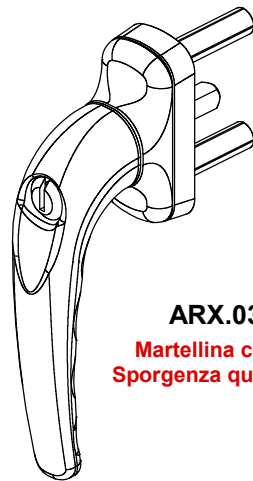
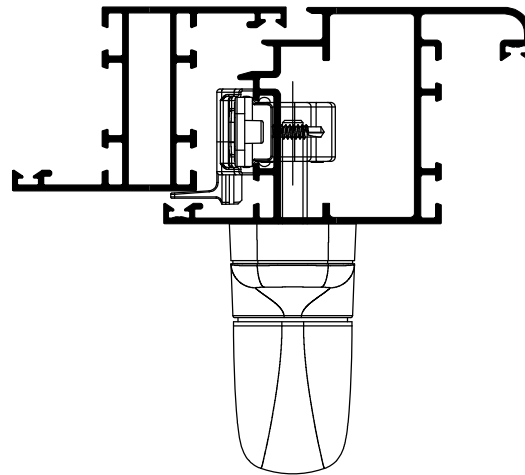

ARX.03.05
Martellina con chiave
Sporgenza quadro mm.24

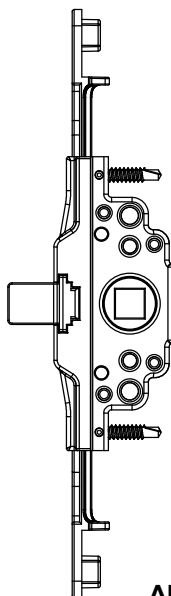
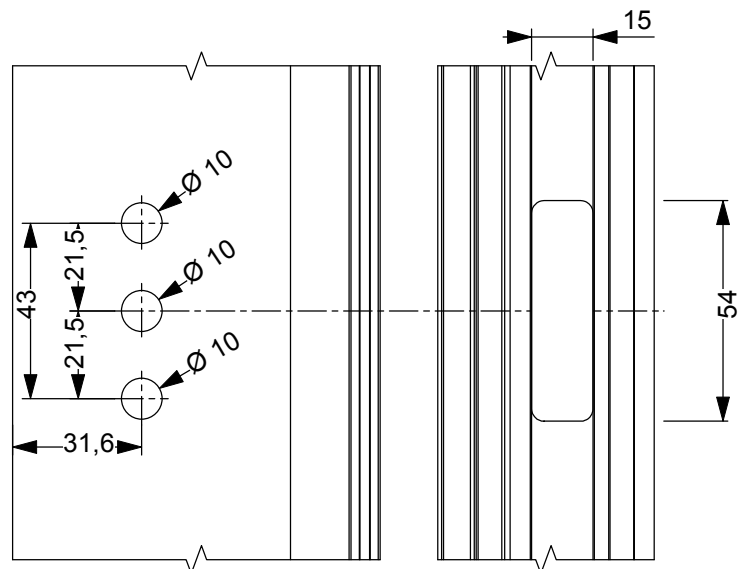

ARX.03.10
Movimentazione Unidirezionale

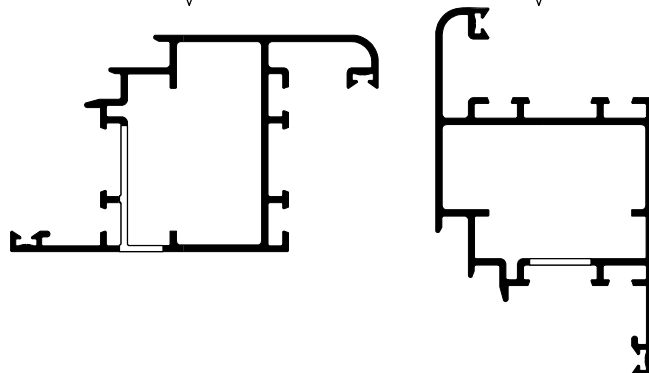



APPLICAZIONE ACCESSORI

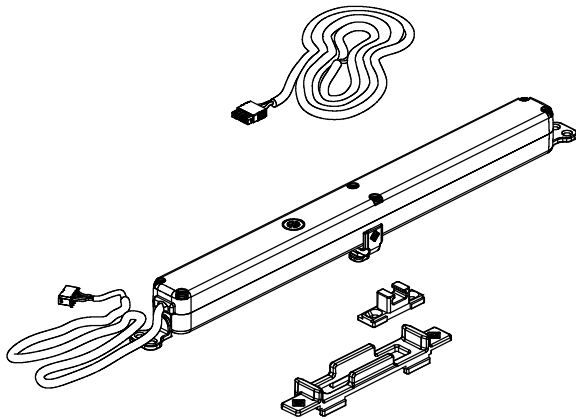

ARX.20.01

"WiCloud Rc" Attuatore a catena radiocomandato

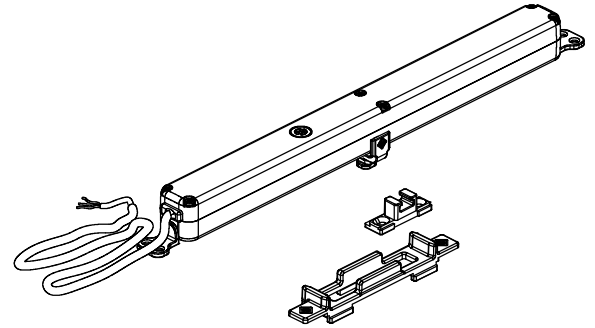

ARX.20.03

"WiCloud Rc" Attuatore a catena

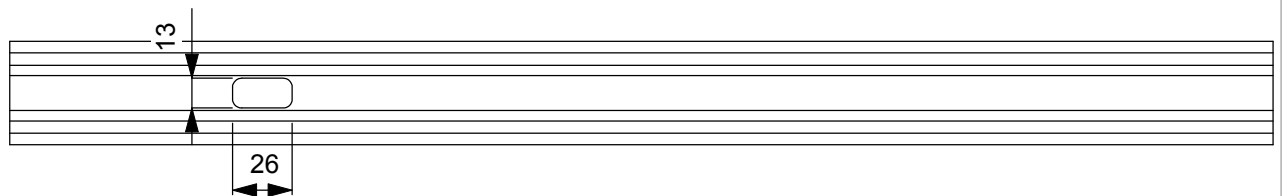
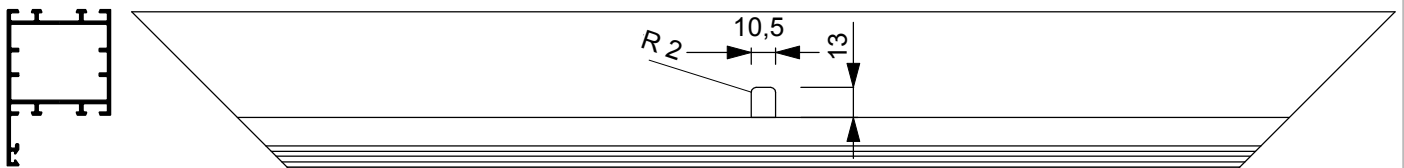
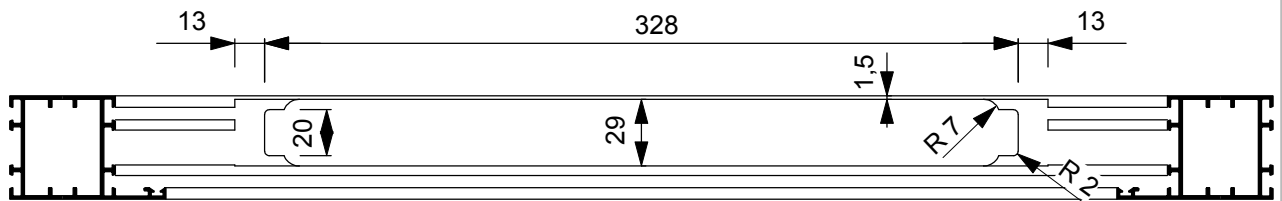



APPLICAZIONE ACCESSORI

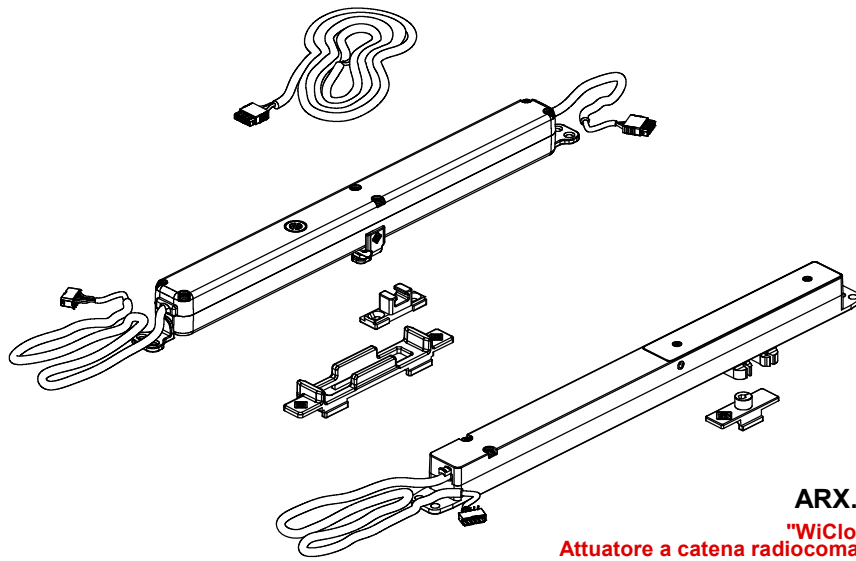

ARX.20.03

"WiCloud Rc - Lock"
Attuatore a catena radiocomandato + serratura elettromeccanica

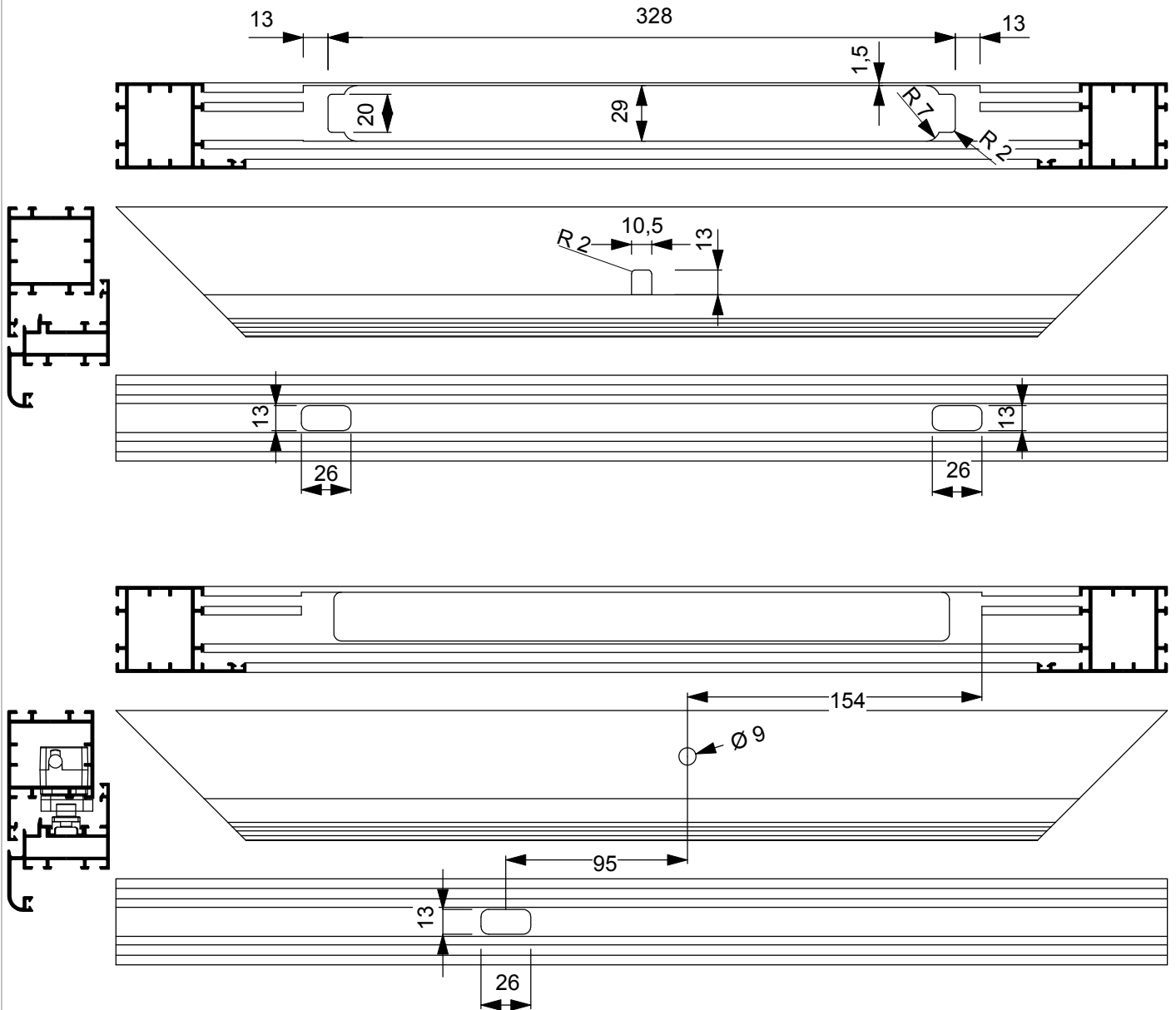



APPLICAZIONE ACCESSORI

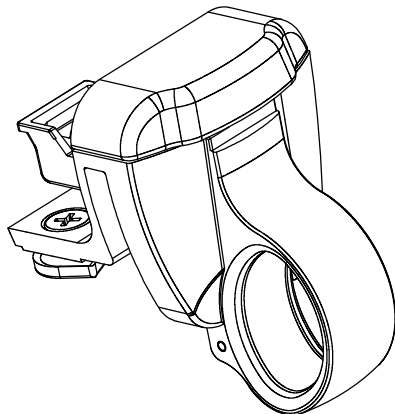

ARX.03.01 / A1501.1

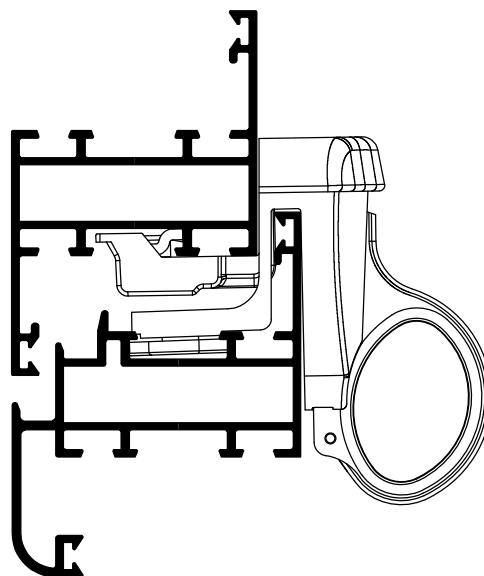



APPLICAZIONE ACCESSORI

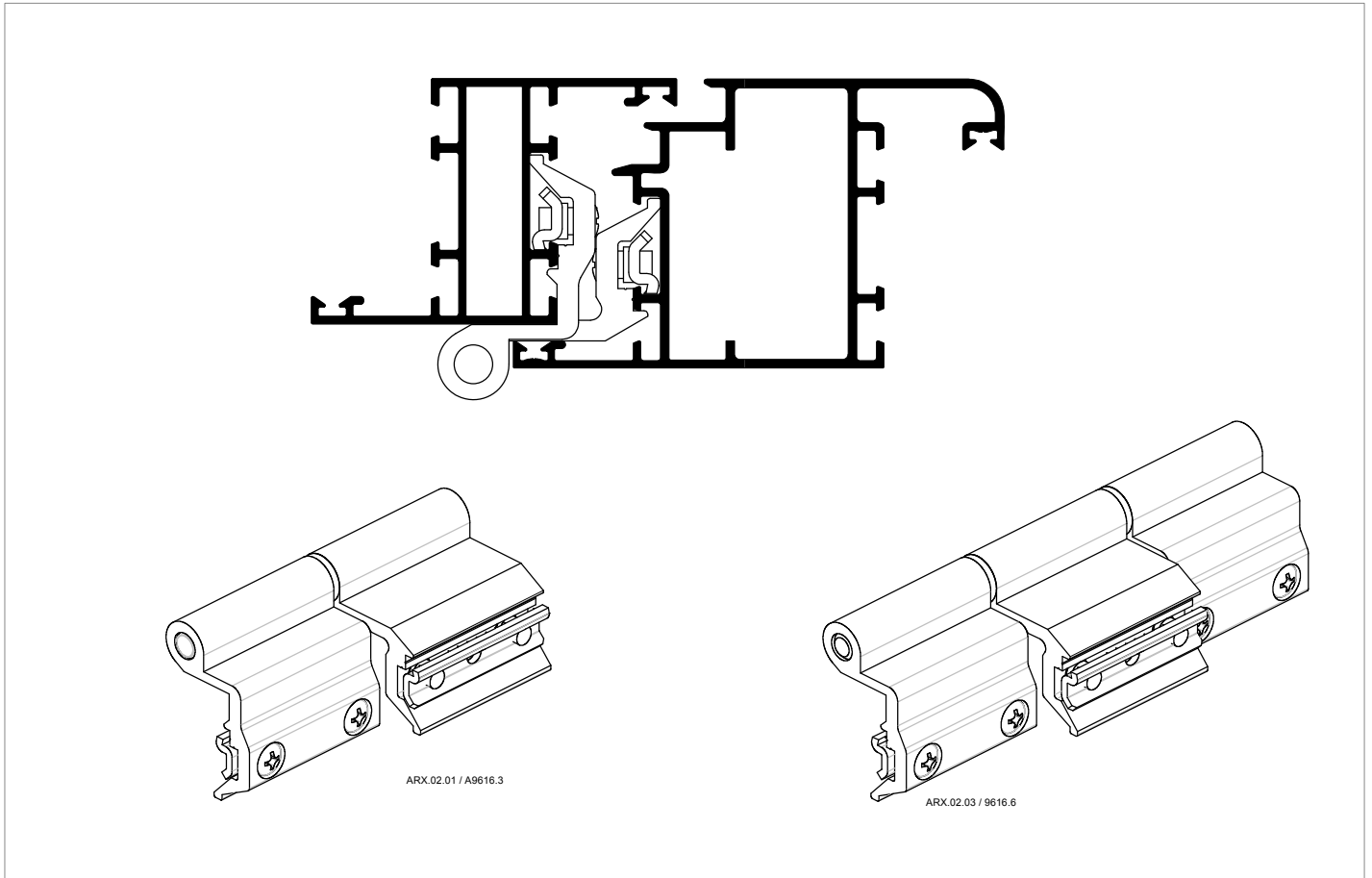

APPLICAZIONE ACCESSORI

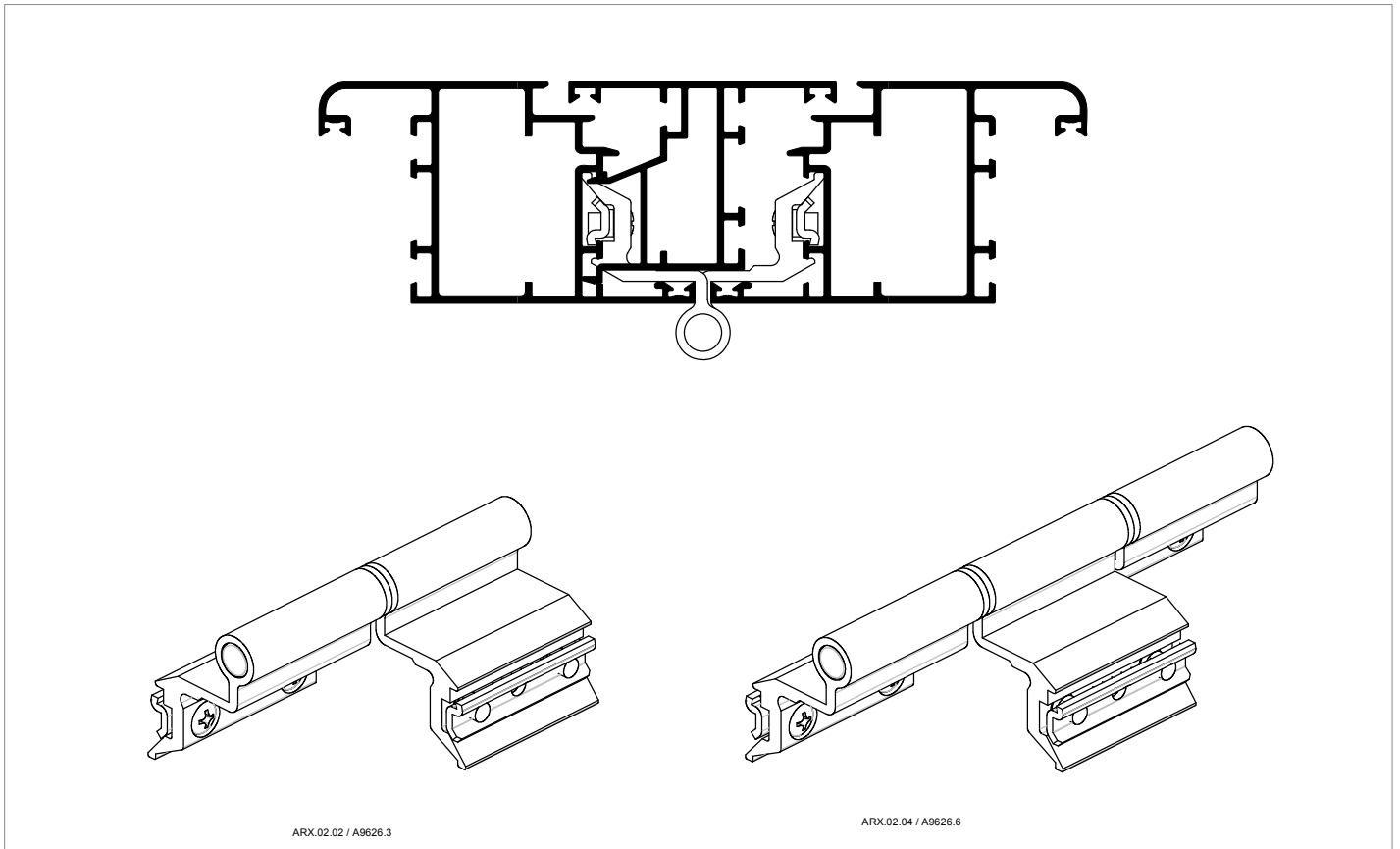



APPLICAZIONE ACCESSORI

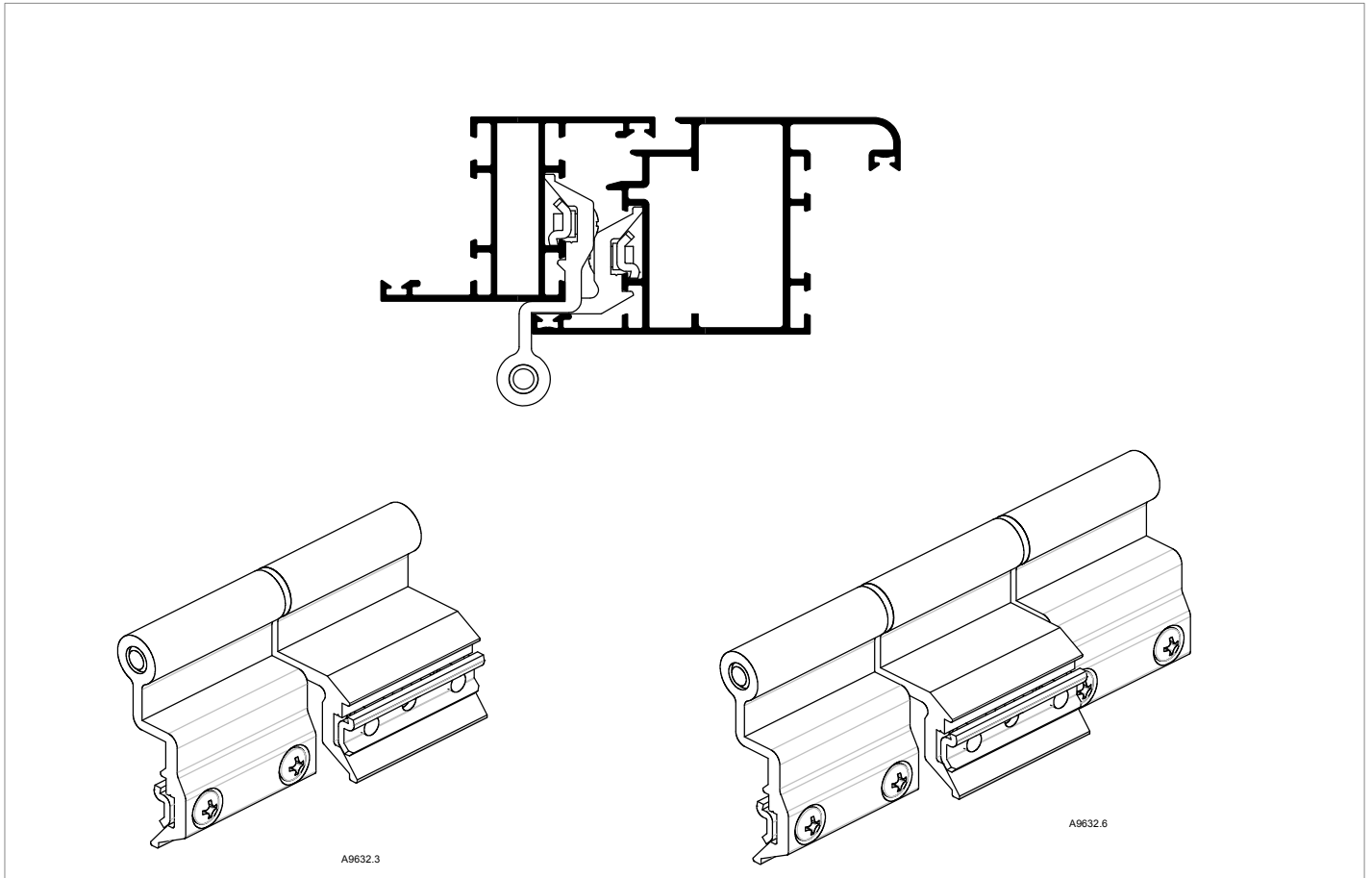

APPLICAZIONE ACCESSORI

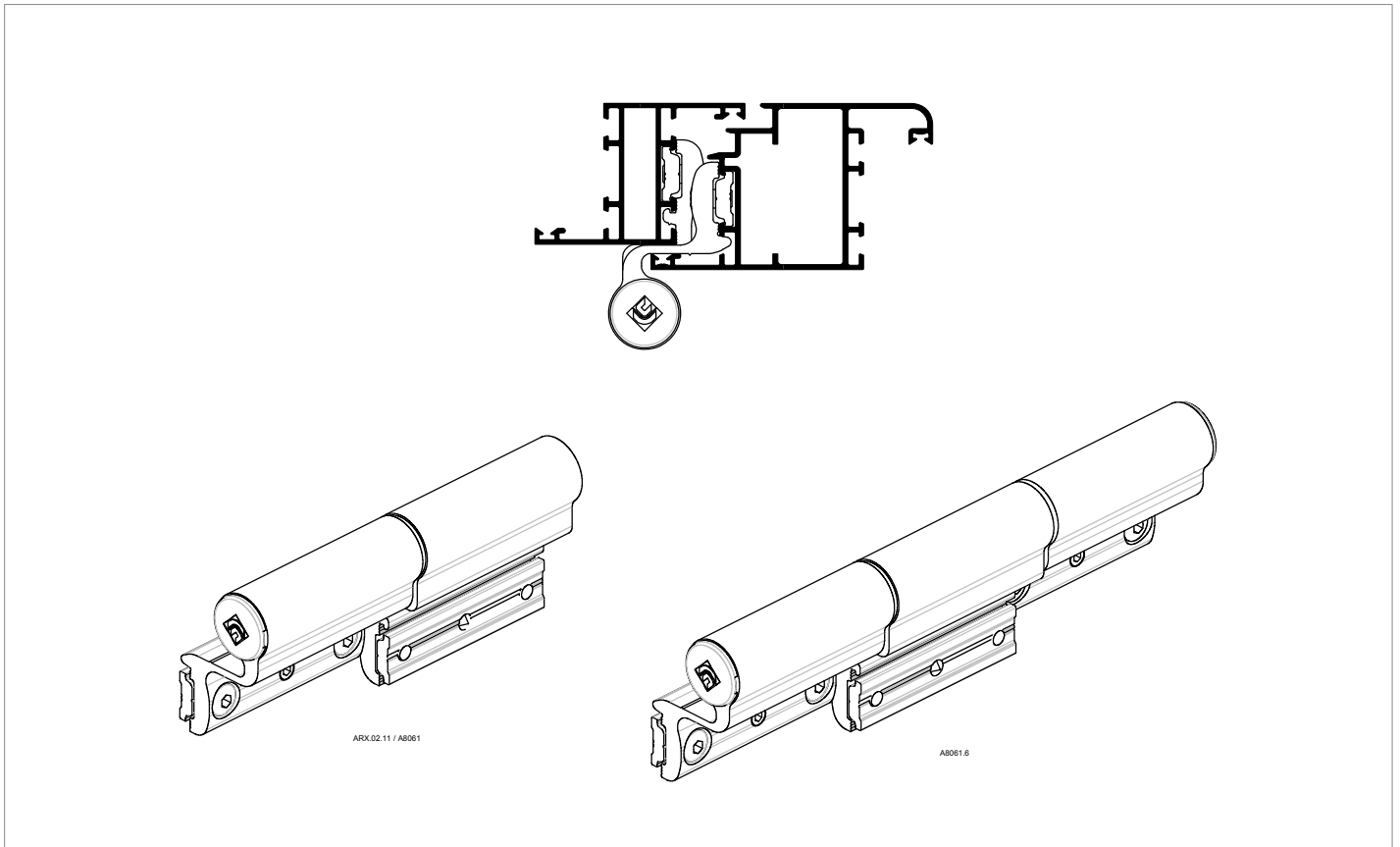



APPLICAZIONE ACCESSORI

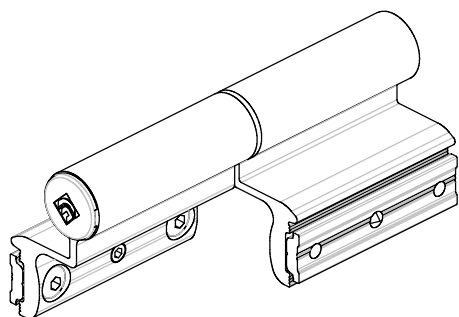
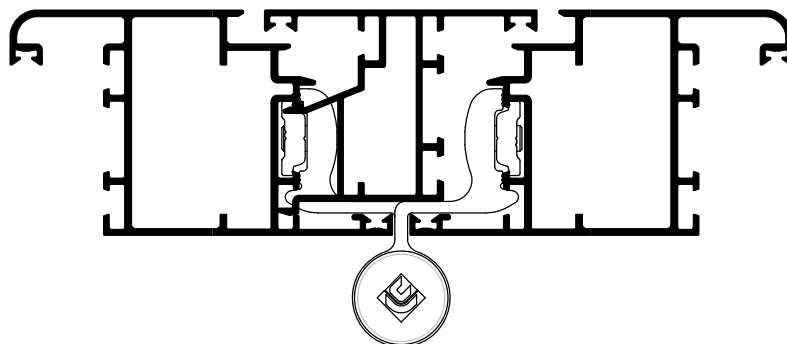

ARX.02.26 / A8062

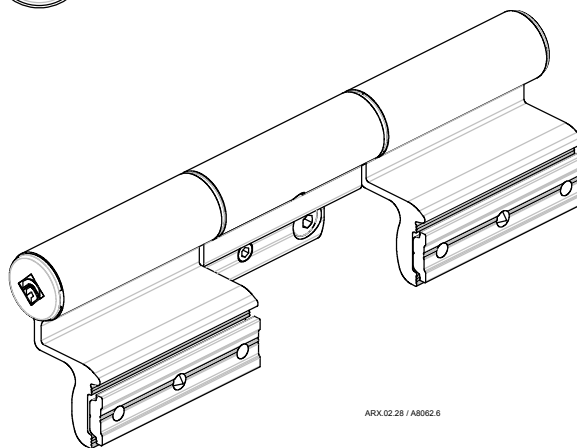

ARX.02.28 / A8062.6

APPLICAZIONE ACCESSORI

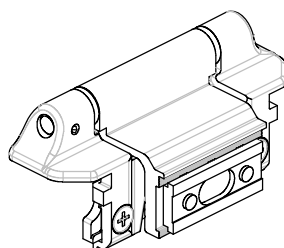
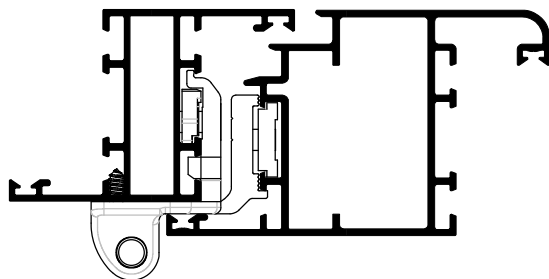

A3551A.70



APPLICAZIONE ACCESSORI

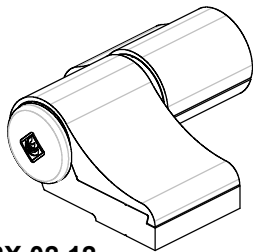
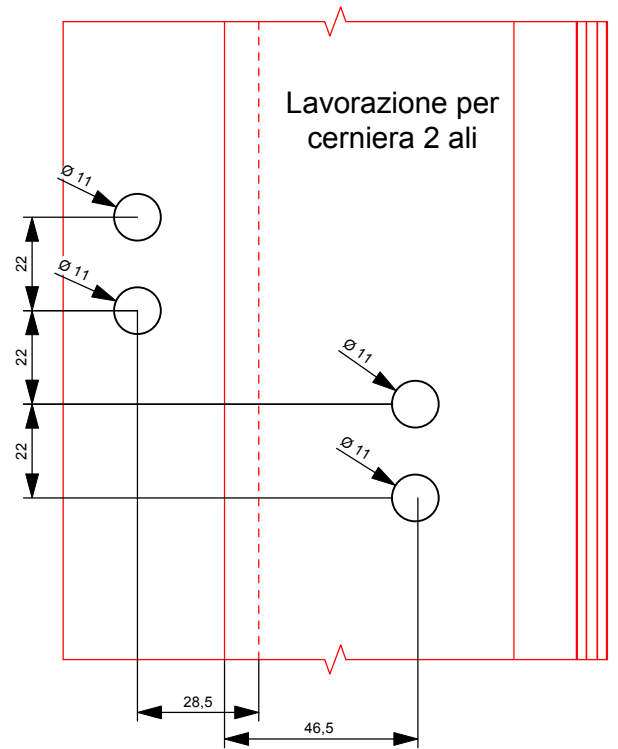
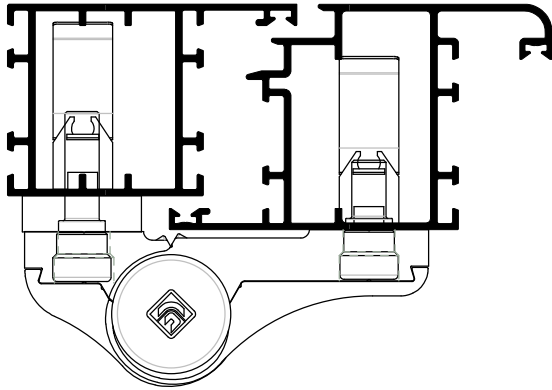

ARX.02.12

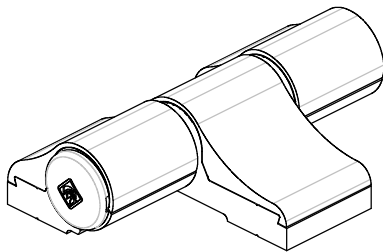

ARX.02.13

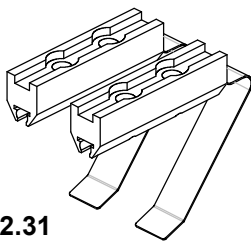

ARX.02.31

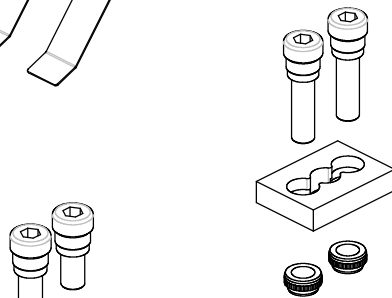
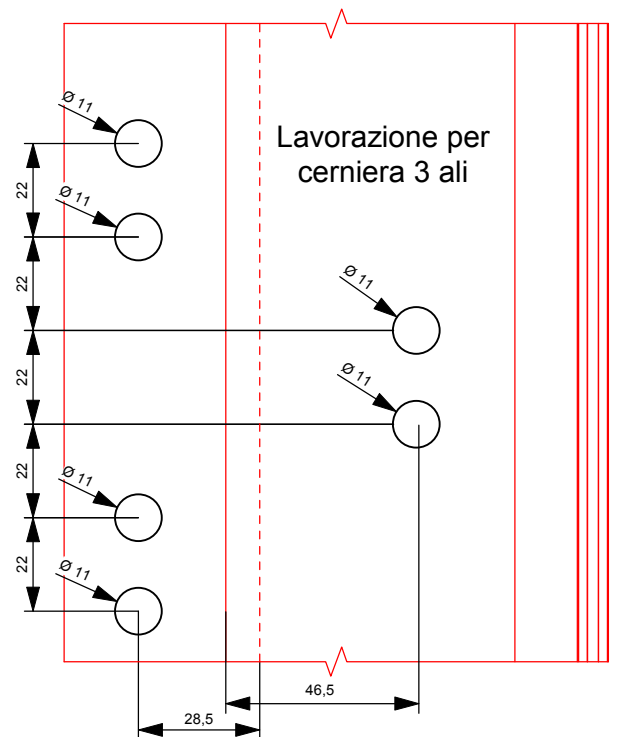

ARX.02.24

ARX.02.16

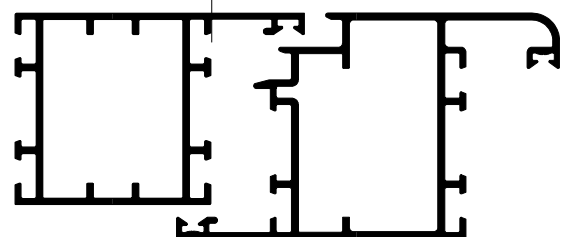



APPLICAZIONE ACCESSORI

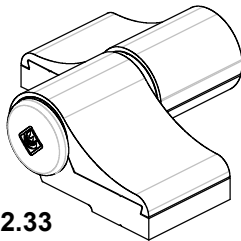
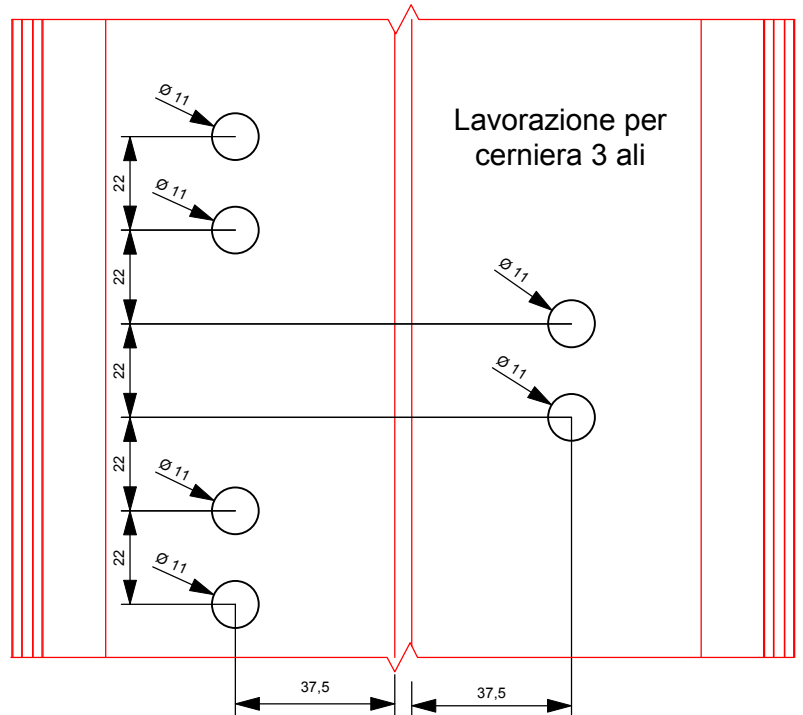
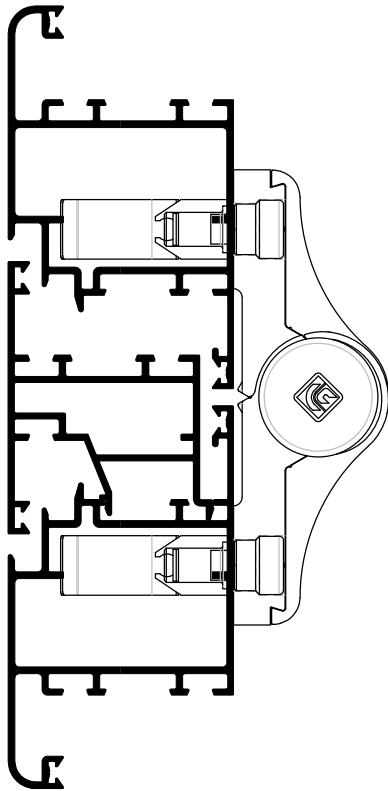

ARX.02.33

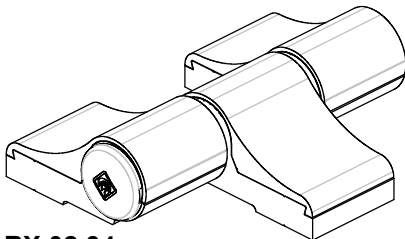

ARX.02.34

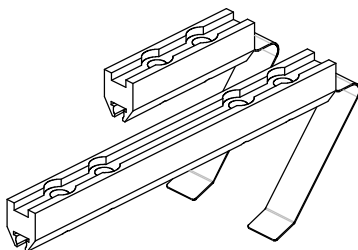
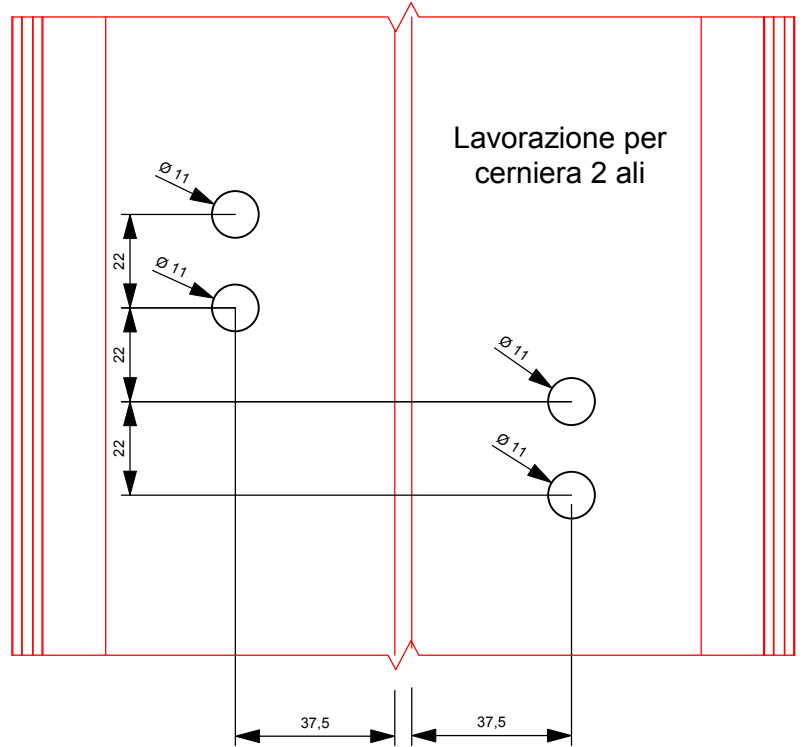

ARX.02.32

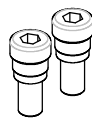



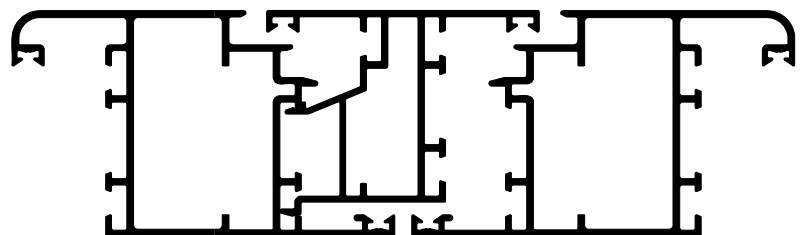



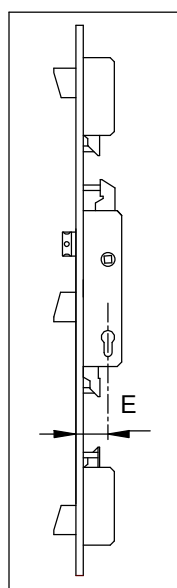
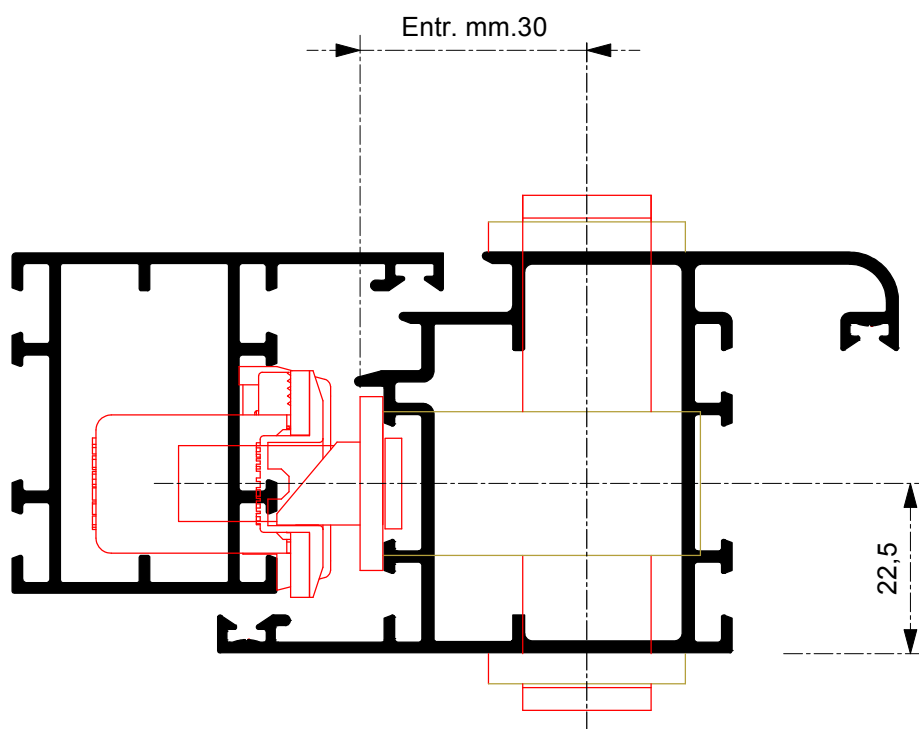

ARX.02.24



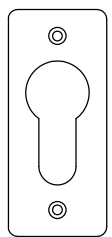
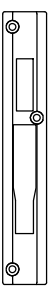

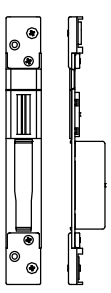
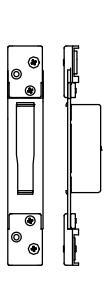
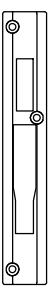
SERRATURE SICUREZZA MULTIPUNTO PIATTA

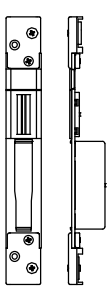
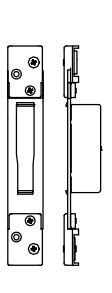
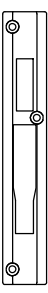

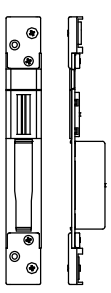
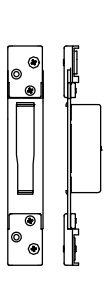
Serratura E= 30 mm		Contropiastra				Cilindro		Borchia
Tipologia	Art.	Nylon	Metallo	Deviatori		 Tradizionale	 Sicurezza	 0120N
				Registrabile	Registrabile			
Catenaccio e scrocco	1570-1670							
Catenaccio e rullo	1575-1675							
Elettrica con maniglia	1577-1677							
		02896N	02896L	02896X	02894X			



SERRATURE A FASCIA

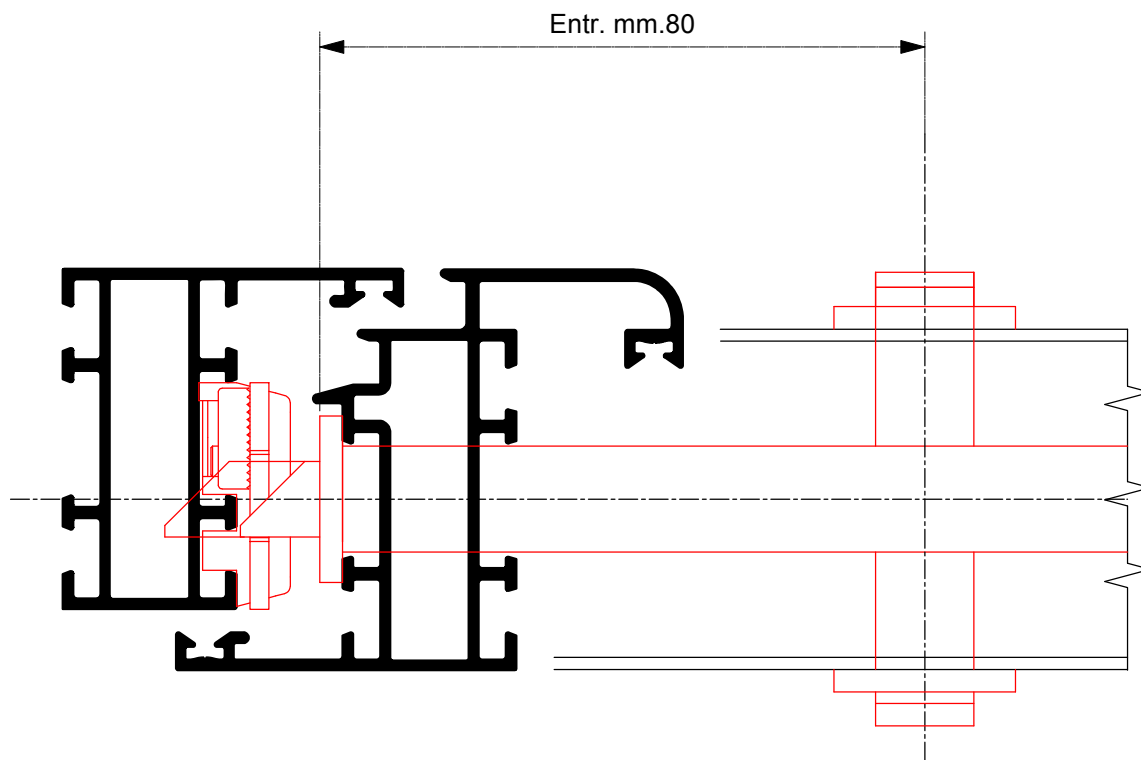

	Serratura E= 80 mm		Contropiastra			Cilindro		Borchia
	Tipologia	Art	Nylon	Metallo	Registrabile			
	Catenaccio e scrocco	880/F22						
	Catenaccio e rullo	885/F22						
	Elettrica con maniglia	888/F22				02881N	02881L	



SERRATURE DI SICUREZZA A FASCIA

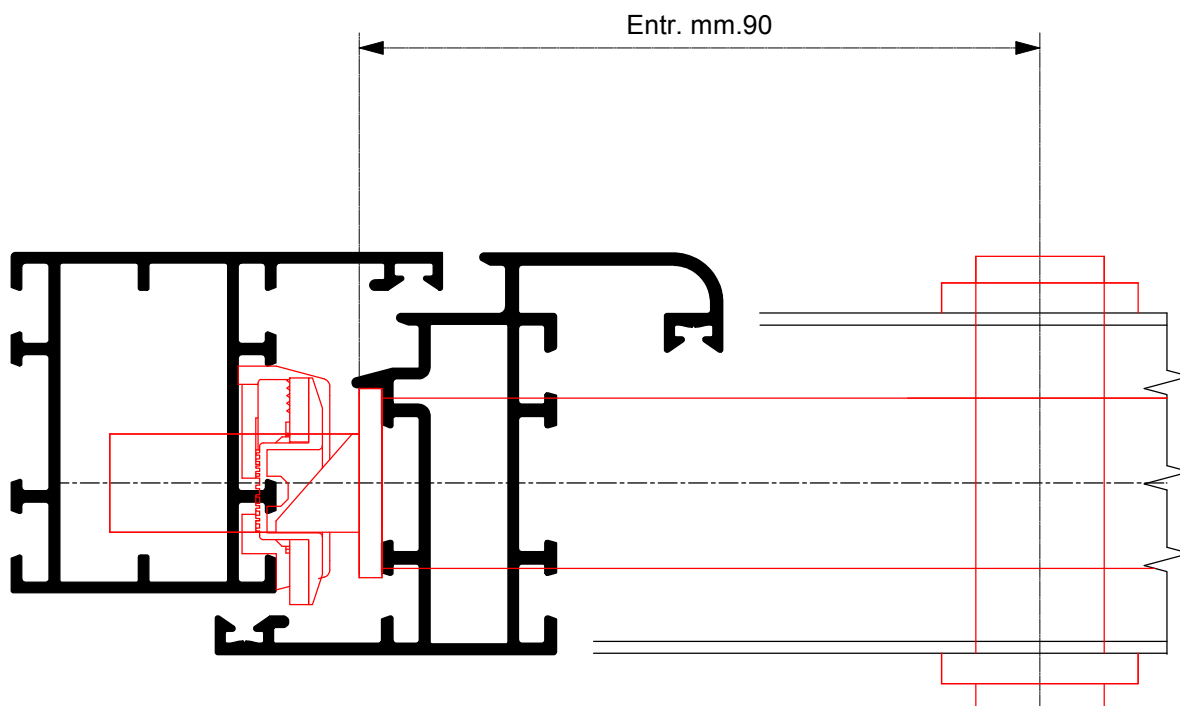





	Serratura E= 90 mm		Contropiastra			Cilindro		Borchia
	Tipologia	Art	Nylon	Metallo	Registrabile	Tradizionale	Sicurezza	
	Catenaccio e scrocco	1940-1970						
	Catenaccio e rullo	1945-1975						
	Elettrica con maniglia	1948-1978				02896N	02896L	

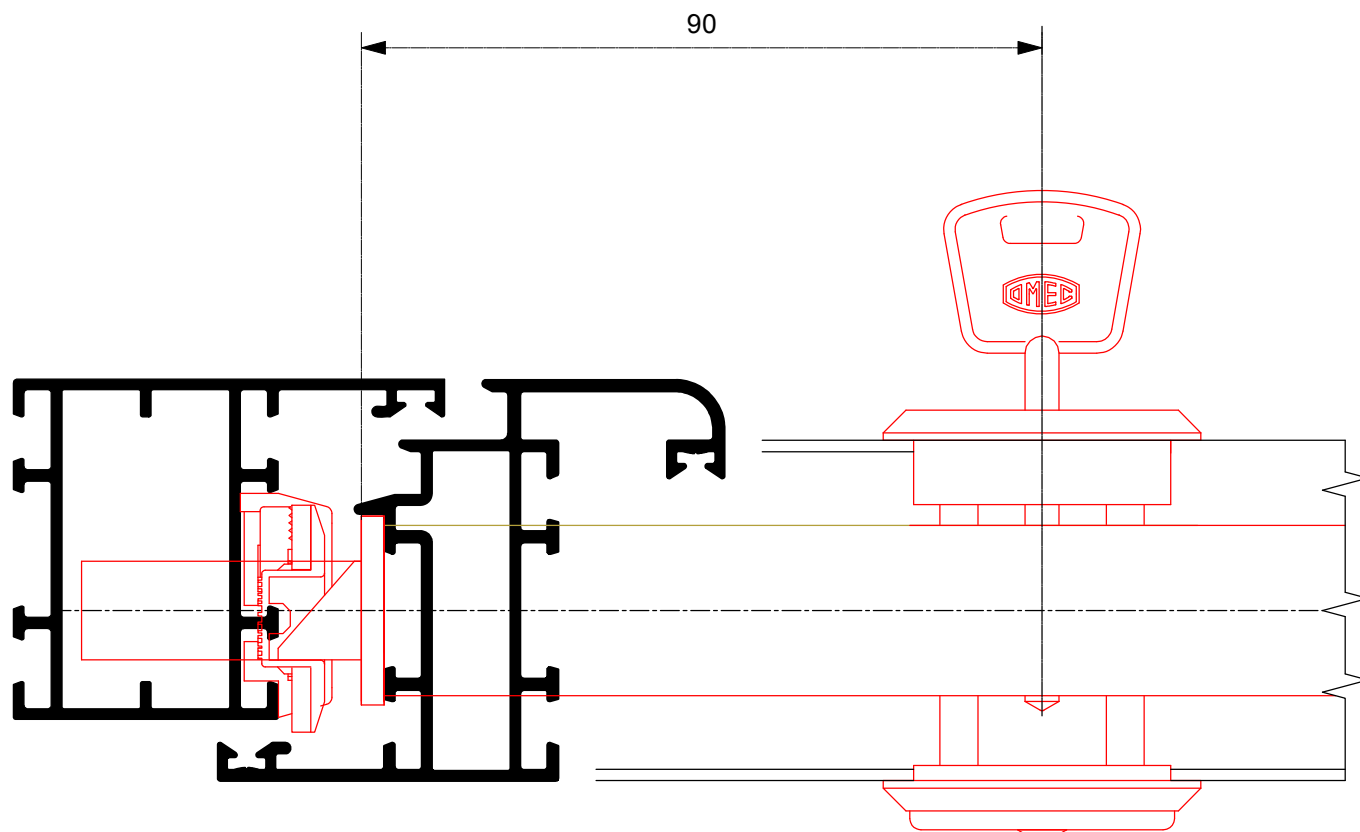

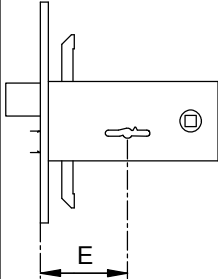
SERRATURE DI SICUREZZA A DOPPIA MAPPA

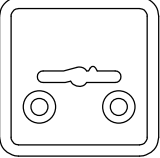

	Serratura Doppia Mappa E= 90 mm			Contropiastra			Borchia
	Tipologia	Art	Art	Nylon	Metallo	Registrabile	
Catenaccio e scrocco	5960	5970				 0590N in dotazione	
Catenaccio e rullo	5965	5975					
Elettrica con maniglia	5968	5978					
			02896N	02896L	02881X		

PAM SYSTEM S.r.l.

S.S. 230 - Fornace Crocicchio
13030 Formigliana (VC)
Tel. 0161 858811 - Fax 0161 858800
www.pamsystemsrl.com - info@pamsystemsrl.com

ALQ System

Via Colano, 9/A 12/K
16162 Genova Bolzaneto
Tel. +39 010 7491941 - Fax +39 010 7450155
www.alqsystem.it - info@alqsystem.it

PAESANI GROUP

Paesani S.r.l.

Via del Grano, 260
47822 Santarcangelo di Romagna (Rn)
Tel. +39 0541 748511 - Fax +39 0541 741208
www.paesani.com - info@paesani.com

Magazzino Nord

Via Luigi Bonati, 21
29017 Fiorenzuola d'Arda (PC)
Tel. +39 0523 943228 - Fax +39 0523 941127
magazzinonord@paesani.com

ALUK GROUP Centro di Firenze Piani

della Rugginosa, 203/206
55066 Reggello (FI)
Tel. 055 8662351/352 - Fax 055 8662065

DIVA S.a.s. di GPD s.r.l. & C.

Via Po, 25 - Z. I. Sambuceto
66020 San Giovanni Teatino (CH)
Tel. 085 4405210 - Fax 085 4405207
www.camel-diva.com - info@camel-diva.com

EUROALL S.r.l.

Strada Comunale della Mola Saracena, 23
00065 Fiano Romano (RM)
Tel. 0765 455228/61 - Fax 0765 455317
www.euroall srl.it - info@euroall srl.it

PROFILATI UMBRIA S.r.l.

Via Dei Tigli, 35
06083 Bastia Umbra (PG)
Tel. 075 8012385-075 8010328 - Fax 075 8012386
profilatiumbria@virgilio.it

TSL ALLUMINIO S.r.l.

Via delle Industrie, 12 00030 San Cesareo (Roma)
Tel. 06 2251591 (Ric. Aut.) - Fax 06 2280693
www.tslalluminio.it - info@tslluminio.it

ALLCAR SERVICE S.r.l.

Via Acuto, 120 - 00131 Roma
Tel. 06 4130626 (Ric. Aut.) - Fax 06 4130367
allcarservice@mclink.it

ALLUCOM S.r.l.

Via Vecchia Barletta 237
Z. Ind. - 76123 Andria (BT)
Tel. 0883 592213 - Fax 0883 552386
www.allucom.com - info@allucom.com

ALLUCOM S.r.l.

Via Zippitelli, 28/B - 70123 (BA)
Tel. 0805058608 - Fax 0805058607
www.allucom.com - info@allucom.com

CARUSO S.r.l.

Z.I. Contrada Le Macere
86019 Vinchiaturo (CB)
Tel. 0874 340024 - Fax 0874 340025
carusosrl1@libero.it

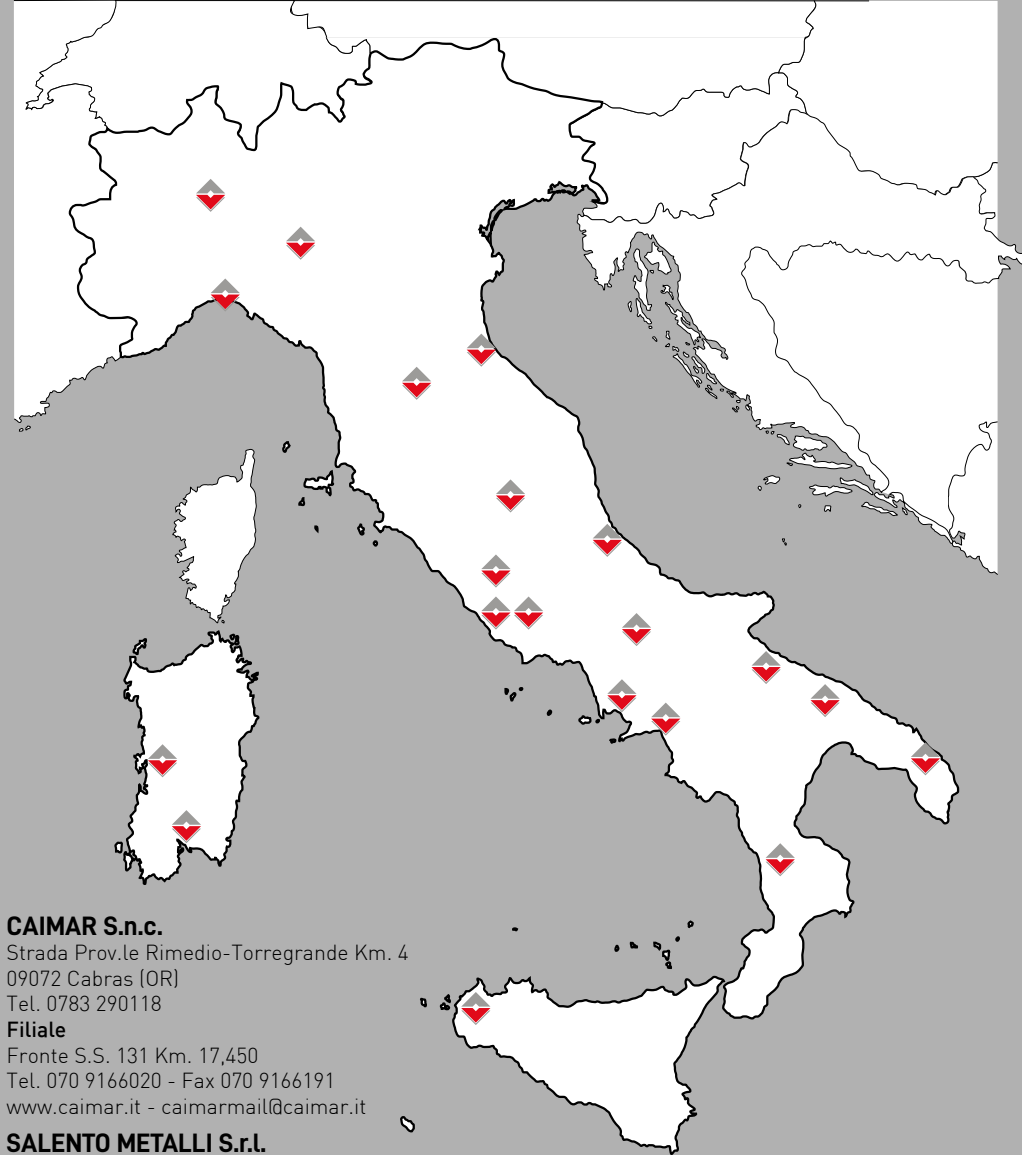

CAIMAR S.n.c.

Strada Prov.le Rimedio-Torregrande Km. 4
09072 Cabras (OR)
Tel. 0783 290118

Filiale

Fronte S.S. 131 Km. 17,450
Tel. 070 9166020 - Fax 070 9166191
www.caimar.it - caimarmail@caimar.it

SALENTO METALLI S.r.l.

Via Federico II, 13 - Zona PIP
73020 Cavallino (LE)
Tel. 0832 614576 - Fax 0832 614635
www.salentometalli.it - info@salentometalli.it

MIDA ALLUMINIO S.r.l.

Via Piano del Principe, 36
80047 San Giuseppe Vesuviano (NA)
Tel. 081 5297373 - Fax 081 8284449
www.midaalluminiogroup.it - info@gruppomida.it

MIDA ALLUMINIO S.r.l.

Loc. Terzerie - Z. Ind.
80061 Ogliastro Cilento (SA)
Tel. 0974 833233 - Fax 0974 844724
www.midaalluminiogroup.it - info@midaalluminiogroup.it

ITALBACOLOR S.r.l.

C.da Valle S. Maria
87024 Fuscaldo (CS)
Tel. 0982 618025 - Fax 0982 720235
www.italbacolor.it - commerciale@italbacolor.it

COMAS S.r.l.

Via Porta Palermo, 84
91011 Alcamo (TP)
Tel. 0924 507050 - Fax 0924 507051
www.comasgroup.it - info@comasgroup.it



www.twinsystems.it info@twinsystems.it

Consorzio **TWIN SYSTEMS**

Via delle Macere, 20 00060 Formello (Roma)
Tel./Fax 06 23260298

