

# CX 700

FINESTRE A BATTENTE  
CON TAGLIO TERMICO

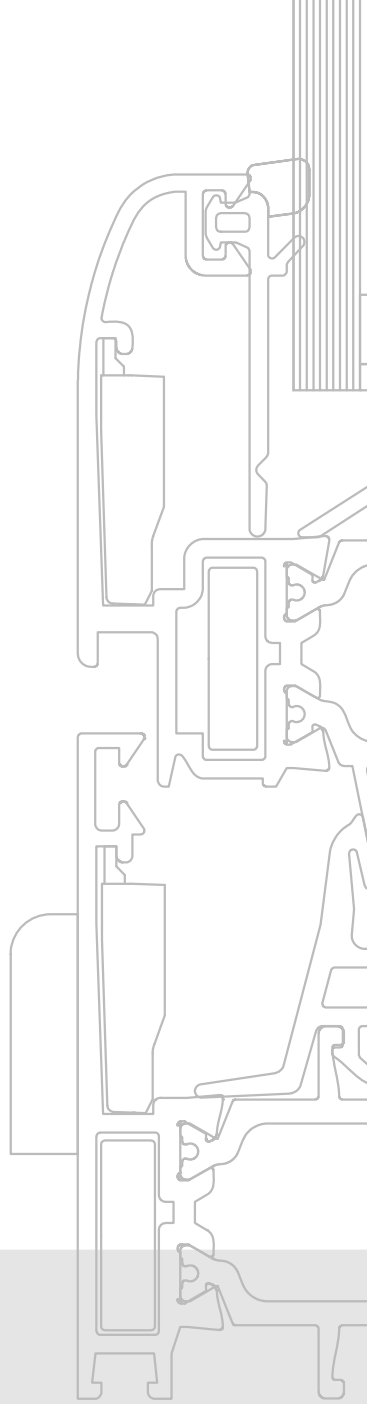

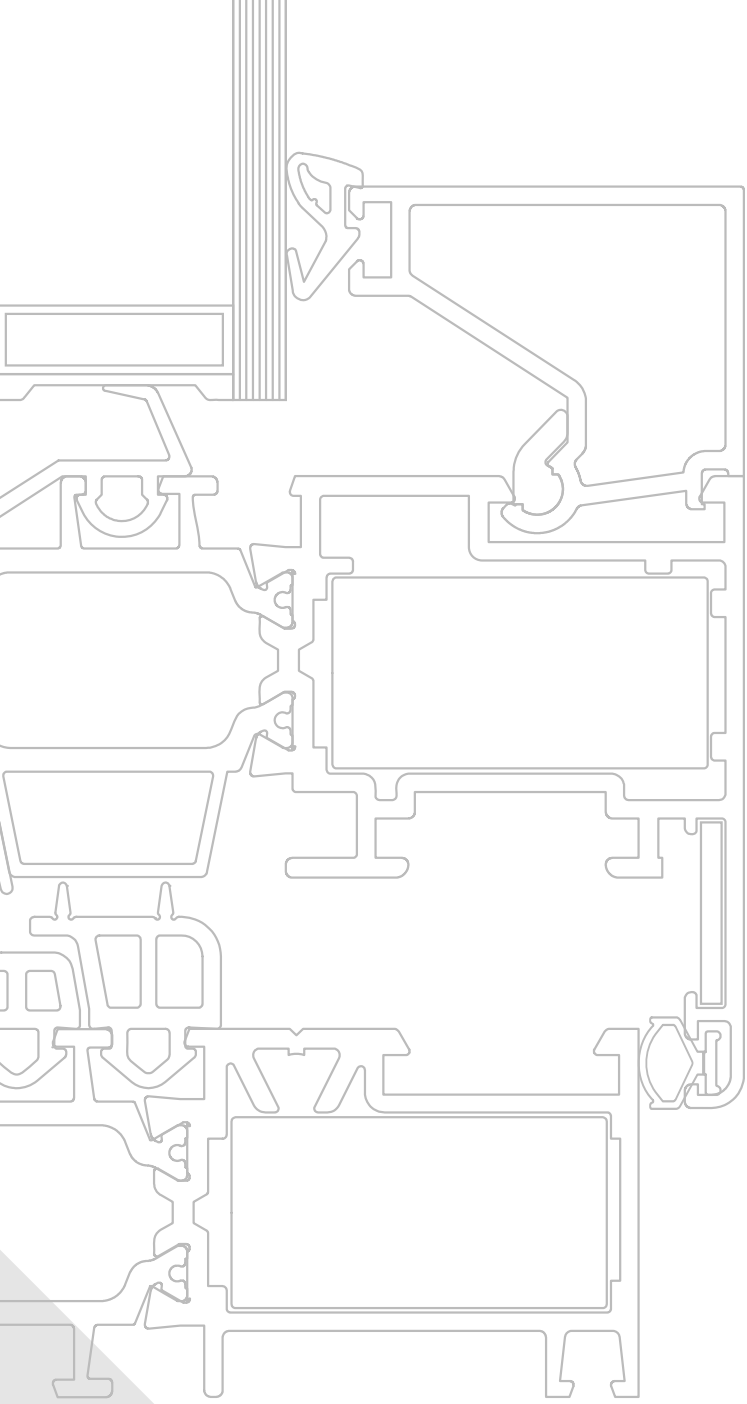



# CX 700

FINESTRE A BATTENTE  
CON TAGLIO TERMICO





**TWIN  
SYSTEMS**



<b>Informazioni generali</b>	<b>Gruppo A</b>	Indice generale Caratteristiche alluminio Descrizione tecnica sistema Descrizione tecnica capitolato Collaudi prestazionali
<b>Profilati</b>	<b>Gruppo B</b>	Elenco profilati Profilati scala 1.1
<b>Accessori e Guarnizioni</b>	<b>Gruppo C</b>	Elenco accessori Elenco guarnizioni
<b>Sezioni</b>	<b>Gruppo D</b>	Sezioni principali in scala 1:1 corredate dei relativi accessori
<b>Tipologie</b>	<b>Gruppo E</b>	Principali tipologie di finestre
<b>Collegamento muratura</b>	<b>Gruppo F</b>	Sezione particolareggiata attacco alla muratura
<b>Lavorazioni / Montaggi</b>	<b>Gruppo G</b>	Schemi lavorazioni Frese Attrezzature



### PESO PROFILATI

Il peso indicato è quello teorico e potrà variare in funzione delle tolleranze di spessore e dimensionali dei profilati (NORMA UNI EN 12020-2)

### LEGA DI ESTRUSIONE

I profilati sono estrusi in lega EN-AW-6060 (UNI EN 573/3)

### DIMENSIONI DEI PROFILATI

Le dimensioni indicate sono quelle teoriche, potranno quindi variare in funzione delle tolleranze dimensionali di estrusione (norma UNI EN 12020-2). Questa variabilità che interessa tutti i profilati, può influire, anche se minimamente, sulle dimensioni di taglio e quindi finali del serramento. Anche la verniciatura, aumentando gli spessori, contribuisce a far variare la dimensione dei profilati e, particolarmente, riduce lo spazio nelle sedi di inserimento delle guarnizioni e degli accessori.

### DIMENSIONI DI TAGLIO E LAVORAZIONI

Le dimensioni teoriche di taglio e le quote delle lavorazioni indicate nel presente catalogo sono esatte, ovvero matematicamente corrette, in certi casi dovranno, nella pratica, essere adattate in base alla precisione ed al tipo di impostazione delle misure delle macchine utilizzate. È pertanto consigliabile nei primi lavori o nel caso di importanti quantità di serramenti effettuare delle campionature di prova.

### PROTEZIONE SUPERFICIALE

Al fine di limitare i processi di corrosione filiforme è importante applicare le seguenti regole:

- utilizzare accessori di assemblaggio in alluminio utilizzare viti in acciaio inox ,
- proteggere le parti tagliate e lavorate con prodotti idonei
- evitare ristagni di condense all'interno dei profilati.

Per la realizzazione di serramenti è necessario attenersi alla tecnologia costruttiva e utilizzare le guarnizioni e gli accessori originali riportati sul catalogo tecnico e al rispetto delle norme, prescrizioni e raccomandazioni vigenti. L'osservanza di quanto sopra determina la garanzia .Su queste basi sono stati realizzati campioni che, collaudati in laboratorio hanno ottenuto i risultati indicati nelle certificazioni. Per il buon funzionamento e la durata degli infissi realizzati con profilati ed accessori del sistema , è necessario effettuare alcune semplici operazioni: una buona pulizia, eliminando residui di calce, cemento e/o altro. È consigliabile peraltro proteggere il manufatto sino al momento della messa in esercizio, lubrificare con olio o grasso neutri le parti in movimento e gli organi di chiusura, controllare il corretto serraggio delle viti e dei grani, controllare gli assetti, registrandoli laddove sono previste regolazioni. Si raccomanda di effettuare queste operazioni almeno con cadenza semestrale. In caso di funzionamento anomalo di qualche componente, evitare assolutamente interventi atti a modificarne le caratteristiche e la sostituzione con ricambi non originali. Ci sembra utile ricordare che interventi di regolazione e/o sostituzione, con particolare riferimento ai meccanismi per oscillo-battente, andranno eseguiti da personale specializzato. Si raccomanda inoltre, in occasione delle operazioni di pulizia, di non utilizzare detergenti che possano deteriorare i trattamenti superficiali, escludendo tassativamente acidi, solventi, materiali abrasivi, spazzole metalliche o comunque in grado di scalfire le superfici, pagliette metalliche e altro.

### DIMENSIONI E TIPOLOGIA DEI SERRAMENTI

La valutazione delle dimensioni dei serramenti, richiede la considerazione di vari fattori quali: il momento d'inerzia dei profilati ,le dimensioni e il peso dei tamponamenti (vetri-pannelli),la larghezza e l'altezza delle parti apribili caratteristiche e portate degli accessori,le condizioni e le quantità degli ancoraggi alle opere morte,l'esposizione, ecc...Fattori che sono valutabili e applicabili, grazie alla buona conoscenza dello stato dell'arte, alle informazioni riportate dai cataloghi, manuali tecnici e dalle normative vigenti. Consigliamo, al fine di evitare inutili contestazioni, di consultare il nostro servizio tecnico sistemi, prima di realizzare serramenti che, per dimensione, forma, esposizione e/o altro possono essere ritenuti atipici. Le soluzioni e le combinazioni proposte in questo catalogo, non hanno carattere limitativo, ma presentano solo le situazioni e combinazioni più comunemente riscontrabili nella realtà. Soluzioni e combinazioni diverse, così come l'adozione di componentistica particolare, ad esempio meccanismi per la realizzazione di ante scorrevoli parallele, ante scorrevoli a libro o altro, sono possibili. A questo proposito il nostro servizio tecnico prodotti per l'edilizia può valutare e proporre le soluzioni più idonee.



## DESCRIZIONE TECNICA PER CAPITOLATO

I profilati per serramenti saranno in lega di alluminio ENAW 6060 (EN 573-3 e EN 755-2) con stato fisico di fornitura UNI EN 515. I telai fissi e le ante mobili dovranno essere realizzati con profilati ad interruzione di ponte termico a tre camere (profilo interno ed esterno tubolari, collegati tra di loro con barrette in poliammide PA 6.6 rinforzate con fibra di vetro).

### INFISSI

Le finestre e le porte finestre dovranno avere un profilato di telaio fisso con profondità minima 70 mm. ed un profilato di anta mobile con profondità minima 78 mm. I profilati di telaio fisso dovranno prevedere, dove necessario, alette incorporate di battuta interna sulla muratura da 22 mm . I profilati di ante mobili dovranno avere un'aletta esterna di battuta per vetro con altezza di 22 mm ed una aletta di battuta interna sul telaio fisso con sormonto di 8 mm. La barretta in poliammide del profilato anta a contatto con la guarnizione di tenuta centrale (giunto aperto), dovrà essere di forma tubolare.

### ISOLAMENTO TERMICO

L'interruzione del ponte termico sarà ottenuta da barrette continue in poliammide da 28 mm. totale e dovrà garantire un valore di trasmittanza termica per l'infisso  $U_w = \dots\dots\dots$  W/m<sup>2</sup>K. L'assemblaggio dei profilati in alluminio a taglio termico dovrà garantire i valori di scorrimento (T) tra profilati in alluminio e barrette in poliammide previsti dalla direttiva tecnica Europea (UEAtc).

### DRENAGGI E VENTILAZIONE

I profilati esterni delle ante mobili dovranno prevedere una gola ribassata per la raccolta delle acque di infiltrazione e di condensa onde poter permettere il libero deflusso delle stesse attraverso apposite asole di scarico. Le barrette in poliammide dovranno avere una conformazione geometrica atta ad evitare eventuale ristagno di acque di infiltrazione e di condensa ed essere perfettamente complanari con le pareti trasversali dei profilati di alluminio.

### ACCESSORI DI ASSEMBLAGGIO

Le giunzioni tra profilati orizzontali e verticali dovranno essere perfettamente solidali e ben allineate tra di loro, sia nella parte esterna che interna dei profilati ed unite mediante apposite squadrette a bottone o, in alternativa, in alluminio estruso o pressofuso, con metodo a spino-cianfrinatura od a cianfrinatura totale. Le sezioni dei profilati orizzontali e verticali dovranno essere opportunamente sigillate prima di essere unite con le squadrette. I fermavetri saranno accoppiati a scatto e posizionati nei canali dei profilati in alluminio .

### GUARNIZIONI

Tutte le guarnizioni: cingivetro, di tenuta, di battuta.... dovranno essere in elastomero (EPDM). In particolare la guarnizione di tenuta centrale (giunto aperto) dovrà assicurare la continuità perimetrale mediante l'impiego di angoli vulcanizzati preformati incollati alla stessa o in alternativa mediante telai vulcanizzati.

### PRESTAZIONI

I serramenti dovranno avere prestazioni di permeabilità all'aria, tenuta all'acqua e resistenza ai carichi del vento conformemente alle norme :  
(UNI-EN 12207 - 12208 - 12210 e UNI-EN 1026 - 1027 - 12211)

Permeabilità all'aria : classe **4**  
Tenuta all'acqua : classe **E 1200**  
Resistenza al vento : classe **C 5**



# CX 700

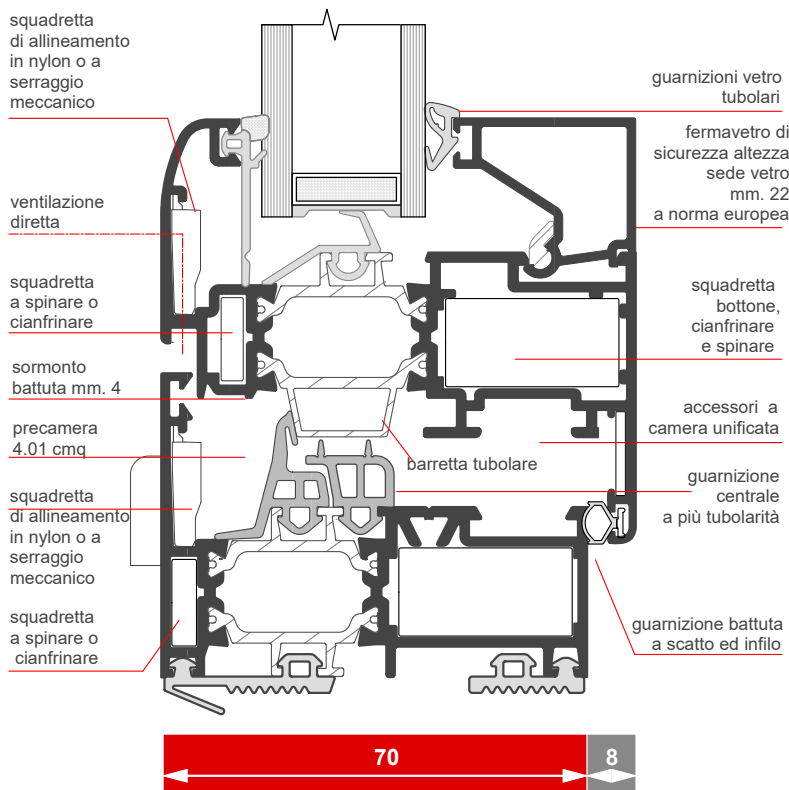

### Schema dimensionale:

Telaio fisso :	mm. 70
Telaio mobile:	mm. 78 (complanare) secondo profilo
Barrette isolanti:	mm. 28 sia per telaio che anta
Fuga perimetrale :	mm. 5
Alloggiamento accessori:	a Camera Europea spazio 11.5 mm.
Giunzione angolare:	con squadrette a bottone, spinare o cianfrinare



### Analisi termica con FLIXO vers.7 e WinIso2D Professional 7.8

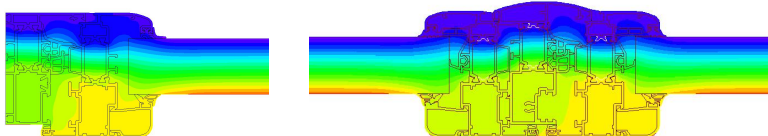

Risultati dei test/ CE product pass conforme ad UNI EN 14351-1:2006+A1:2010

Permeabilità all'aria:	<b>Classe 4</b>
Tenuta all'acqua:	<b>Classe E 1200</b>
Resistenza al carico di vento:	<b>Classe C5</b>
Isolamento acustico:	fino a <b>45 dB</b>
Resistenza all'effrazione:	<b>Classe RC 2</b>

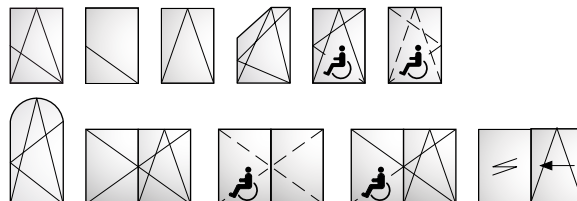

### Caratteristiche tecniche:

#### Tecnologia:

- Sistema a camera multipla ad elevato isolamento termico con design simmetrico e qualità dell'assemblaggio garantita
- Spessore dei tamponamenti fino a 55 mm

### Isolamento termico:

### Serramento campione

- Valore  $U_w$  **1.51** W/(m<sup>2</sup>K) con vetro camera  $U_g = 1.0$  W/(m<sup>2</sup>K) certificato con canalina  $\psi = 0.036$  W/(m<sup>2</sup>K) su finestra normalizzata con H = 1480 mm. ed L = 1535 mm.
- Valore  $U_w$  **1.15** W/(m<sup>2</sup>K) con vetro triplo  $U_g = 0.5$  W/(m<sup>2</sup>K) certificato con canalina  $\psi = 0.031$  W/(m<sup>2</sup>K) su finestra normalizzata con H = 1480 mm. ed L = 1535 mm.

Dimensioni massime ammesse per il calcolo  $U_w$  su serramento campione fino a 2.3 mq (secondo norma UNI EN 14351-1:2006+A1:2010)

### Ferramenta:

- Sistema con accessori funzionali a camera unificata, spazio 11.5 mm. personalizzati ed a pista 16 mm.
- giunzione angolare con squadrette a bottone/ spinare/cianfrinare ed allineamento

### Impiego:

- Profilati per finestre che consentono la costruzione di infissi ad una, due o più ante a battente, nella versione a giunto aperto complanari all'esterno e a sormonto all'interno. Sono possibili anche specchiature fisse, wasistas, anta-ribalta. Profilati per porte: consentono la costruzione di porte ad una o due ante, apribili all'interno, con sopraluci fissi od apribili e vetrine



Agenti Atmosferici



**Tenuta all'acqua\*** EN 1027 - EN 12208  
Capacità di un inÿsso di impedire infiltrazioni quando è investito da un usso d'acqua ed è presente una differenza di pressione tra interno ed esterno.

Pressione d'aria Km/h	0Pa	50Pa	100Pa	150Pa	200Pa	250Pa	300Pa	450Pa	600Pa	750Pa	900Pa	1050Pa	1200Pa	1350Pa	1500Pa
Classe	0	32	45	55	64	72	78	96	111	126	138	149	159	169	178
	-	1A	2A	3A	4A	5A	6A	7A	8A	E750	E900	E1050	E1200	E1350	E1500

L'inÿsso TWIN, con una pressione del vento pari ad una velocità di 159 Km/h (1200Pa) non ha avuto infiltrazioni

Classe Raggiunta  
**E 1200**

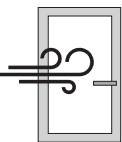

**Permeabilità all'aria\*** EN 1026 - EN 12207  
Caratteristica di un inÿsso chiuso di lasciare filtrare aria quando è presente una differenza di pressione tra l'interno e l'esterno; minori saranno i volumi dispersi, maggiore sarà la qualità del serramento.

Pressione Vento Classe	150Pa	300Pa	450Pa	600Pa
	1	2	3	4

L'inÿsso TWIN ha superato la prova con una pressione del vento pari ad una velocità di 111 Km/h (600Pa)

Classe Raggiunta  
**4**

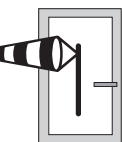

**Resistenza al vento\*** EN 12211 - EN 12210  
Capacità di un inÿsso sottoposto a forti pressioni e/o depressioni, come quelle causate dal vento, di mantenere una deformazione ammissibile, di conservare le proprietà iniziali a salvaguardia della sicurezza degli utenti.

Pressione d'aria Flessione Classe	400Pa	800Pa	1200Pa	1600Pa	2000Pa	>2000Pa
	A (~ 1/150)	B (~ 1/200)	C (~ 1/300)			
	1	2	3	4	5	Exxx

Classe Raggiunta  
**C5**

\*Serramento a 2 ante, dimensione L = mm.1488 ed H = mm.1668 - Certificato prova n° RP n° 0970-CPD-RP0618 | Disponibili altre certificazioni



**Potere fonoisolante** EN ISO 140-3, EN ISO 717-1  
Perdita di isolamento acustico rispetto al vetro DRw (dB) a partire dalla classe di permeabilità all'aria dell'inÿsso (UNI EN 12207)

Classe Perdita	1	2	3	4
	8dB	6dB	4dB	2dB

**N.B.** Per valori DRw ~ 38 db è ammesso l'utilizzo di questo metodo tabellare  
Per valori DRw > 39 db in su è necessario realizzare un campione al vero e sottoporre a prove di Laboratorio.

Attenuazione Rumori Esterni  
Fino a  
**45 dB**

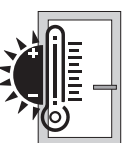

**Trasmittanza Termica**  
Flusso di calore che passa attraverso il serramento per m2 di superficie e per ogni grado di differenza di temperatura tra interno ed esterno.

**Uw** **1.51 W/m² K**  
Finestra a 2 ante normalizzata (1535 mm. x 1480 mm; vetro camera Ug=1.0 W/m2K certificato con canalina psi=0.036 W/m K)

**Uw** **1.15 W/m² K**  
Finestra a 2 ante normalizzata (1535 mm. x 1480 mm; vetro triplo Ug=0.5 W/m2K certificato con canalina psi=0.031 W/m K)

Effrazione



**Resistenza all'effrazione**  
Capacità di un inÿsso di resistere ad un'intrusione violenta a seguito di una applicazione di una forza fisica e con l'aiuto di attrezzi  
Finestra a 2 ante (1230 mm. x 1480 mm) - CERTIFICATO CP384-VAL-3400A.52

Classe di resistenza	RC 1	RC 2	RC 3
	forza fisica (calci, pugni, spallate)	semplice attrezzatura (cunei, cacciaviti)	R2 + Piede di Porco

L'inÿsso TWIN, resiste in modo efficace ai tentativi di intrusione interna.

Resistenza Effrazione  
**RC 2**

Resistenze Meccaniche

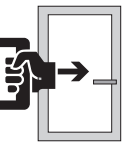

**Forze di azionamento** EN 13115  
Idoneità di un inÿsso di permettere una facile apertura con uno sforzo minimo

Classe Forza Applicata	0	1	2
------------------------	---	---	---

L'inÿsso TWIN, consente grande facilità di apertura con uno sforzo minimo.

Classe Raggiunta  
**1**



**Resistenza meccanica** EN 12046 - EN 13115  
Capacità di un inÿsso di resistere ai carichi applicati senza rotture, deformazioni permanenti o torsioni tali da pregiudicare il suo corretto funzionamento.

Classe Carico Verticale Torsione Statica	1	2	3	4
	200 N	400 N	600 N	800 N

L'inÿsso TWIN resiste ai carichi applicati senza torsioni, deformazioni permanenti o rotture.

Classe Raggiunta  
**4**

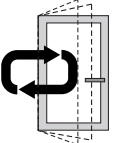

**Resistenza ai cicli di apertura e chiusura** EN13126 - 4  
Capacità di un inÿsso di resistere nel tempo a ripetuti cicli di apertura e chiusura.

Grado N° Cicli	3	4	5
	10'000	15'000	25'000

L'inÿsso TWIN resiste efficacemente ai cicli di apertura e chiusura

Grado Resistenza  
**5**



**Resistenza all'urto** (METODO DI PROVA CON CORPO DURO) EN 13049  
Capacità di un inÿsso di resistere in caso di urti involontari o accidentali.

Classe Altezza Caduta	1	2	3	4	5
	200mm	300mm	450mm	700mm	950mm

L'inÿsso TWIN, resiste efficacemente agli urti.

Classe Raggiunta  
**1**





**Battente Una e Due Ante Cerniere  
ACX.02.01 e ACX.02.03**

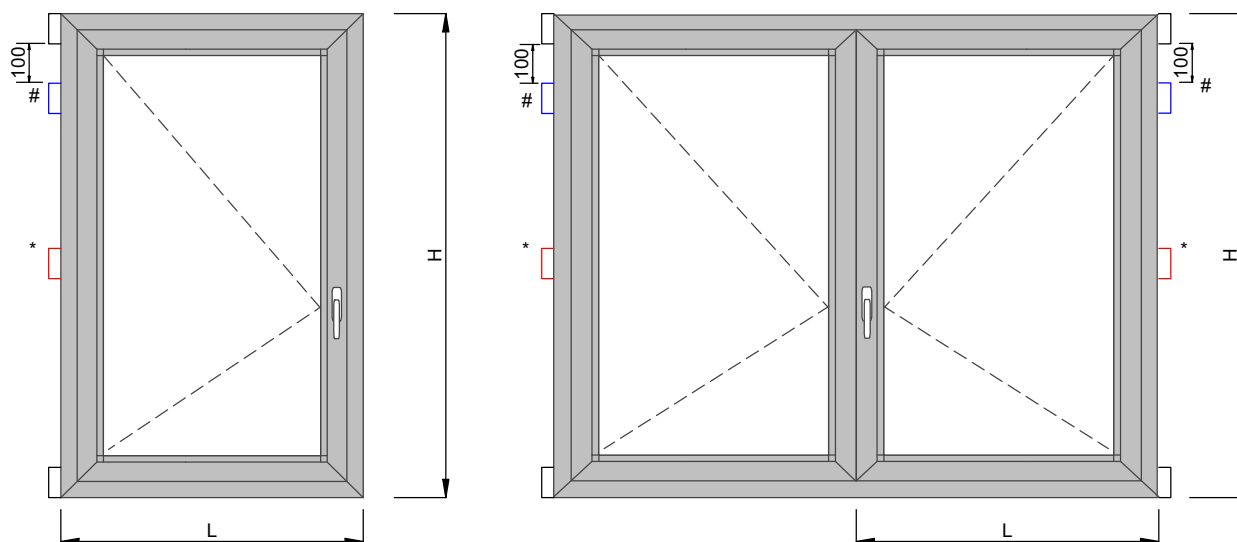

**Dimensioni Anta Minima (LxH): 430 x 500**

Norma per Stringa di Prodotto EN 1935:2004

Tipo	Categoria D'uso (1)	Durabilità (2)	Massa (3)	Resistenza Fuoco (4)	Sicurezza D'uso (5)	Resistenza Corrosione (6)	Resistenza Effrazione (7)	Grado Cerniera (8)
<b>ACX.02.01</b>	1	4	2 (80Kg)	0	1	4	0	6
<b>ACX.02.03</b>	1	4	3 (120Kg)	0	1	4	0	9

Dimensione Massime Anta (LxH)

Un Anta 2 Cerniere	Un Anta 3 Cerniere *	Un Anta 4 Cerniere *e#
1000x1600	1200x1800	1300x2100
Due Ante 2 Cerniere	Due Ante 3 Cerniere *	Due Ante 4 Cerniere *e#
1000x1500	1000x1700	1000x2100

Legenda Stringa di Prodotto

Categoria D'uso (1)	Durabilità (2) Cicli test	Massa (3) x cerniera	Resistenza Fuoco (4)	Sicurezza D'uso (5)	Resistenza Corrosione (6)	Resistenza Effrazione (7)	Grado Cerniera (8)
1:leggero	3:10.000	2: 40 Kg	0: non idoneo	1: soddisfatto	4: 240h in nebbia salina in accordo alla UNI EN 1670:2008	1	il suo valore è dato dalla combinazione di Massa e cicli
2:Medio	4.25.000	3: 60 Kg					
3:Pesante	7:200.000	4: 80 Kg	1: idoneo				
4:Intenso		5: 100 Kg					



**Battente Una e Due Ante Cerniere a pettine**  
**ACX.08.09**

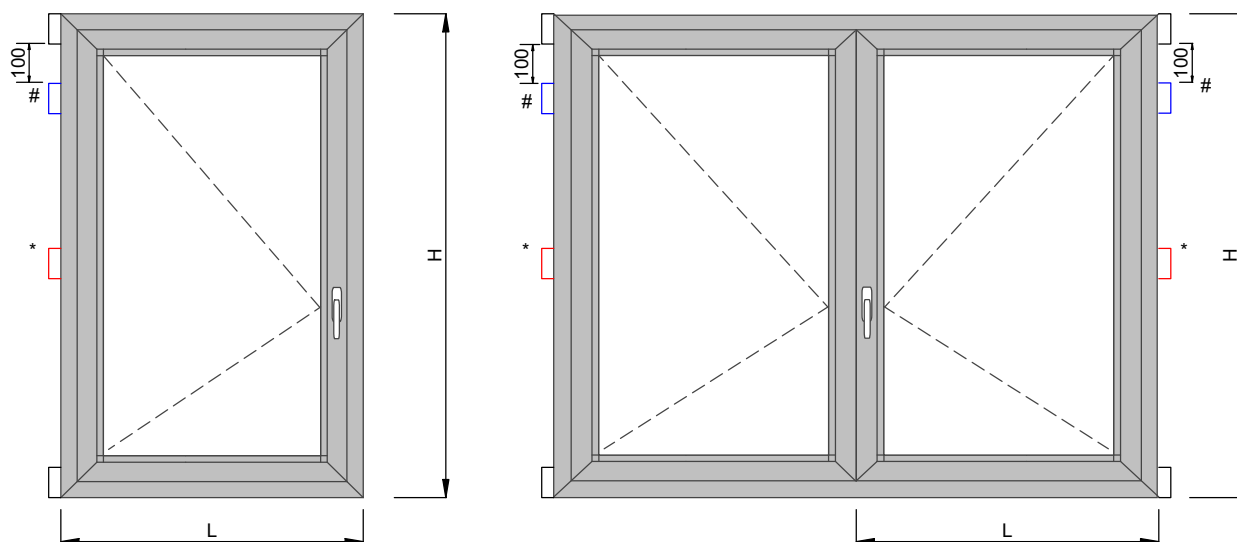

Dimensione Anta Minima (LxH): 430 x 500

Norma per Stringa di Prodotto EN 1935:2004

Tipo	Categoria D'uso (1)	Durabilità (2)	Massa (3)	Resistenza Fuoco (4)	SicurezzaD'uso (5)	Resistenza Corrosione (6)	Resistenza Effrazione (7)	Grado Cerniera (8)
<b>ACX.08.09</b>	2	7	2 (80Kg)	0	1	4	0	7

Dimensione Massime Anta (LxH)

Un Anta 2 Cerniere	Un Anta 3 Cerniere *	Un Anta 4 Cerniere *e#
1000x1600	1200x1800	1300x2100
Due Ante 2 Cerniere	Due Ante 3 Cerniere *	Due Ante 4 Cerniere *e#
1000x1500	1000x1700	1000x2100

Legenda Stringa di Prodotto

Categoria D'uso (1)	Durabilità (2) Cicli test	Massa (3) x cerniera	Resistenza Fuoco (4)	SicurezzaD'uso (5)	Resistenza Corrosione (6)	Resistenza Effrazione (7)	Grado Cerniera (8)
1:leggero	3:10.000	2: 40 Kg	0: non idoneo	1: soddisfatto	4: 240h in nebbia salina in accordo alla UNI EN 1670:2008	1	il suo valore è dato dalla combinazione di Massa e cicli
2:Medio	4.25.000	3: 60 Kg					
3:Pesante	7:200.000	4: 80 Kg	1: idoneo				
4:Intenso		5: 100 Kg					

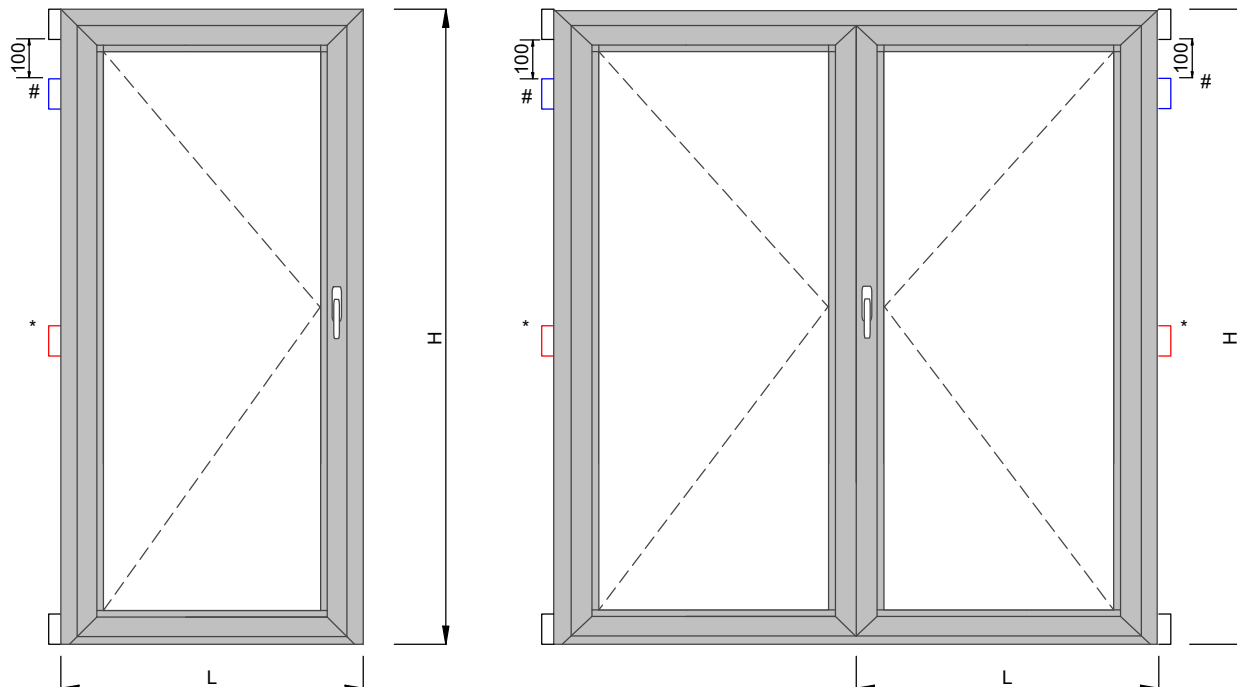
**Cerniere per Profili Porte Applicazione Esterna  
ARX.02.12 (2 ali) e ARX.02.13 (3 ali)**

**Norma per Stringa di Prodotto EN 1935:2004**

Tipo	Categoria D'uso (1)	Durabilità (2)	Massa (3)	Resistenza Fuoco (4)	Sicurezza D'uso (5)	Resistenza Corrosione (6)	Resistenza Effrazione (7)	Grado Cerniera (8)
<b>ARX.02.12</b>	3	7	4 (160Kg)	0	1	4	0	11
<b>ARX.02.13</b>	3	7	5 (200Kg)	0	1	4	0	12

**Dimensione Massime Anta (LxH)**

Un Anta 2 Cerniere	Un Anta 3 Cerniere *	Un Anta 4 Cerniere *e#
1000x2200	1200x2200	1300x2200
Due Ante 2 Cerniere	Due Ante 3 Cerniere *	Due Ante 4 Cerniere *e#
800x2200	1000x2200	-

**Legenda Stringa di Prodotto**

Categoria D'uso (1)	Durabilità (2) Cicli test	Massa (3) x cerniera	Resistenza Fuoco (4)	Sicurezza D'uso (5)	Resistenza Corrosione (6)	Resistenza Effrazione (7)	Grado Cerniera (8)
1:leggero	3:10.000	2: 40 Kg	0: non idoneo 1: idoneo	1: soddisfatto	4: 240h in nebbia salina in accordo alla UNI EN 1670:2008	1	il suo valore è dato dalla combinazione di Massa e cicli
2:Medio	4.25.000	3: 60 Kg					
3:Pesante	7:200.000	4: 80 Kg					
4:Intenso		5: 100 Kg					



### Aperture Oscillo battenti (140 Kg.) Una e Due Ante ACX.08.01 e ACX.08.01 L

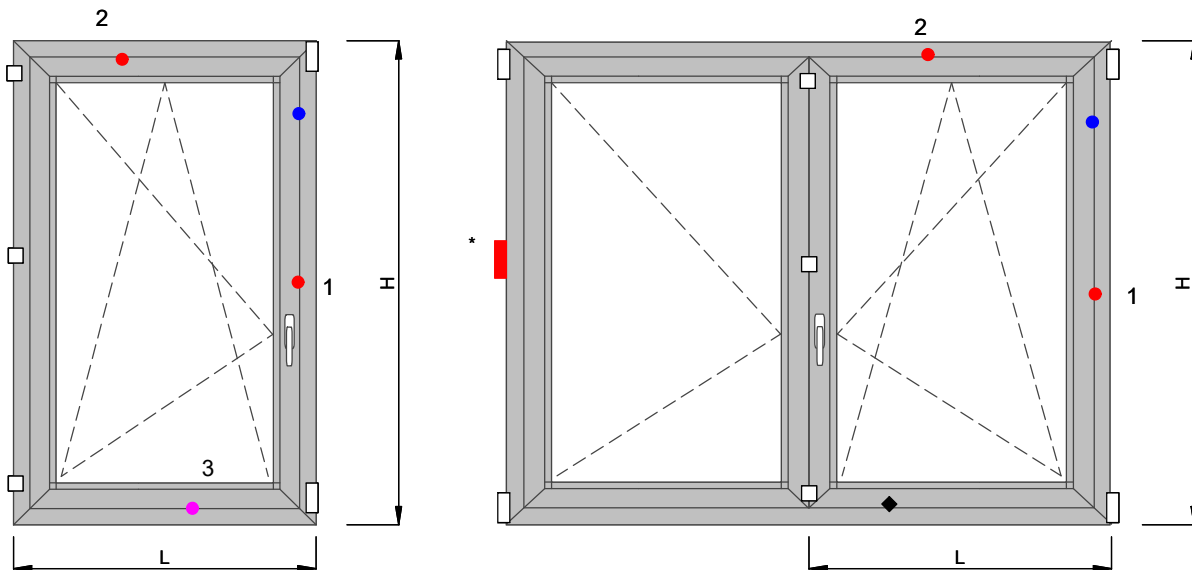

- Punti di chiusura su Kit base **ARX.08.01**
- ◆ □ Punti di chiusura su Kit base **ARX.08.01 L**
- Punti di chiusura supplementari **ARX.08.06**
- Punti di chiusura supplementari **ARX.08.16**
- Punti di chiusura supplementari **ARX.08.16**

#### Norma per Stringa di Prodotto UNI EN 13126-8:2006

Tipo	Categoria D'uso (1)	Durabilità (2)	Massa (3)	Resistenza Fuoco (4)	Sicurezza D'uso (5)	Resistenza Corrosione (6)	Resistenza Effrazione (7)	Applicazione (8)	Dimensione di prova (9)
<b>ACX.08.01</b>	-	<b>4</b>	(140Kg)	<b>0</b>	<b>1</b>	<b>4</b>	-	<b>8</b>	1550x1400
<b>ACX.08.01L</b>	-	<b>4</b>	(140Kg)	<b>0</b>	<b>1</b>	<b>4</b>	-	<b>8</b>	1550x1400

#### Braccio corto **ACX.08.22** e **ACX.08.22L**

	Anta Singola LxH	Anta Doppia LxH	Punti di chiusura
Dimensioni Min	395x500	395x500	ACX.08.01 - ACX.08.01L
Dimensioni Max	450x500	450x500	ARX.08.01 - ARX.08.01L

#### Braccio Medio **ACX.08.03** e **ACX.08.22L**

	Anta Singola LxH	Anta Doppia LxH	Punti di chiusura
Dimensioni Min	451x500	445x500	ACX.08.01 - ACX.08.01L
Dimensioni Max	650x1200	650x1200	KIT + ACX.08.06
Dimensioni Max	650x2200	650x2200	KIT + ACX.08.06 + ACX.08.16

#### Braccio Lungo **ACX.08.24** e **ACX.08.24L**

	Anta Singola LxH	Anta Doppia LxH	Punti di chiusura
Dimensioni Min	651x600	651x600	ACX.08.01 - ACX.08.01L
Dimensioni Max	651x1400	651x1400	ACX.08.01 + ACX.08.06
Dimensioni Max	651x2200	651x2200	KIT + ACX.08.06 + ACX.08.16
Dimensioni Max	1200x1400	1200x1400	KIT+ ACX.08.06 + ACX.08.16 (n°2)
Dimensioni Max	1200x2200	1200x2200	KIT + ACX.08.06 + ACX.08.16 (n°3)
Dimensioni Max	1200x1400	-	KIT + ACX.08.06 + ACX.08.16 (n°3)
Dimensioni Max	1200x2200	-	-

#### Legenda Stringa di Prodotto

Categoria D'uso (1)	Durabilità (2) Cicli	Massa (3)	Resistenza Fuoco (4)	Sicurezza D'uso (5)	Resistenza Corrosione (6)	Resistenza Effrazione (7)	Applicazione (8)	Dimensione di prova (9)
-	4:15.000 a/r+5.000 battente	Portata Certificazione	0: non idoneo	1: Soddisfatto	4: 240h UNI EN 1670:2008	-	8:Privato	Dimensione Campione di prova

**LIMITI IMPIEGO DEL SISTEMA**

TIPOLOGIA		PROFILI					
		<b>CX70.201</b>			<b>CX70.202</b>		
		<b>Jx</b> 37.73 cm <sup>4</sup> <b>Wx</b> 9.46 cm <sup>3</sup>			<b>Jx</b> 51.50 cm <sup>4</sup> <b>Wx</b> 13.13 cm <sup>3</sup>		
		<b>Jy</b> 9.96 cm <sup>4</sup> <b>Wy</b> 2.80 cm <sup>3</sup>				<b>Jy</b> 31.00 cm <sup>4</sup> <b>Wy</b> 6.51 cm <sup>3</sup>	
		<b>CX70.203</b>			<b>CX70.206</b>		
		<b>Jx</b> 42.53 cm <sup>4</sup> <b>Wx</b> 9.93 cm <sup>3</sup>			<b>Jx</b> 56.75 cm <sup>4</sup> <b>Wx</b> 13.79 cm <sup>3</sup>		
		<b>Jy</b> 14.47 cm <sup>4</sup> <b>Wy</b> 3.76 cm <sup>3</sup>				<b>Jy</b> 39.71 cm <sup>4</sup> <b>Wy</b> 7.83 cm <sup>3</sup>	
		<b>CX70.204</b>					
		<b>Jx</b> 47.57 cm <sup>4</sup> <b>Wx</b> 11.87 cm <sup>3</sup>					
		<b>Jy</b> 14.63 cm <sup>4</sup> <b>Wy</b> 3.71 cm <sup>3</sup>					
		<b>Pressione del vento (Pa) : 1200 Pascal</b>		Dimensione Minima	Dimensione Massima	Dimensione Minima	Dimensione Massima
<b>Finestra ad 1 anta</b>	L anta (mm)	<b>430</b>	<b>1200</b>	<b>430</b>	<b>1500</b>		
	H anta (mm)	<b>700</b>	<b>1700</b>	<b>750</b>	<b>1900</b>		
<b>Porta balcone ad 1 anta</b>	L anta (mm)	<b>430</b>	<b>1200</b>	<b>430</b>	<b>1200</b>		
	H anta (mm)	<b>750</b>	<b>2000</b>	<b>750</b>	<b>2400</b>		

TIPOLOGIA		PROFILI					
		<b>CX70.201</b>			<b>CX70.202</b>		
		<b>Jx</b> 38.05 cm <sup>4</sup> <b>Wx</b> 9.49 cm <sup>3</sup>			<b>Jx</b> 50.61 cm <sup>4</sup> <b>Wx</b> 12.79 cm <sup>3</sup>		
		<b>Jy</b> 10.07 cm <sup>4</sup> <b>Wy</b> 2.70 cm <sup>3</sup>				<b>Jy</b> 30.43 cm <sup>4</sup> <b>Wy</b> 6.15 cm <sup>3</sup>	
		<b>CX70.203</b>			<b>CX70.206</b>		
		<b>Jx</b> 42.59 cm <sup>4</sup> <b>Wx</b> 9.97 cm <sup>3</sup>			<b>Jx</b> 55.73 cm <sup>4</sup> <b>Wx</b> 13.74 cm <sup>3</sup>		
		<b>Jy</b> 14.72 cm <sup>4</sup> <b>Wy</b> 3.64 cm <sup>3</sup>				<b>Jy</b> 39.26 cm <sup>4</sup> <b>Wy</b> 7.44 cm <sup>3</sup>	
		<b>CX70.204</b>					
		<b>Jx</b> 48.26 cm <sup>4</sup> <b>Wx</b> 12.00 cm <sup>3</sup>					
		<b>Jy</b> 14.49 cm <sup>4</sup> <b>Wy</b> 3.69 cm <sup>3</sup>					
		<b>Pressione del vento (Pa) : 1200 Pascal</b>		Dimensione Minima	Dimensione Massima	Dimensione Minima	Dimensione Massima
<b>Finestra ad 2 anta</b>	L anta (mm)	<b>430</b>	<b>1000</b>	<b>430</b>	<b>1200</b>		
	H anta (mm)	<b>700</b>	<b>1600</b>	<b>750</b>	<b>1800</b>		
<b>Porta balcone ad 2 anta</b>	L anta (mm)	<b>430</b>	<b>1000</b>	<b>430</b>	<b>1200</b>		
	H anta (mm)	<b>750</b>	<b>2000</b>	<b>750</b>	<b>2300</b>		



## LA MARCATURA CE DELLE FINESTRE E PORTE PEDONALI SENZA CARATTERISTICHE DI RESISTENZA AL FUOCO E/O DI TENUTA AL FUMO

Il marchio **CE**, apposto sui prodotti da costruzione, attesta la loro conformità ai requisiti essenziali definiti dalla direttiva 89/106/CE "Prodotti da costruzione", emanata dal Consiglio della Comunità Europea il 21/12/1988 ed attuata, in Italia, dal D.P.R. n. 246 del 21/04/1993.

La marcatura CE di uno specifico prodotto da costruzione diviene obbligatoria, al fine di immettere il prodotto in un mercato della Comunità Europea, allorché sia stata emessa dal CEN, su mandato della Comunità Europea, una "specificazione tecnica" (norma o benessere tecnico) che regolamenti la sua applicazione.

La responsabilità per la verifica dei requisiti del prodotto e per l'apposizione della marcatura CE spetta al suo fabbricante.

Al fine di garantire i requisiti richiesti dalle relative norme, il fabbricante è tenuto a:

- predisporre un piano di controllo della produzione (FPC). E' un sistema di procedure e controlli da eseguire durante le fasi di produzione;

- effettuare delle "prove iniziali di tipo" (ITT) sul prodotto al fine di determinare le prestazioni. Le modalità di prova dei requisiti del prodotto sono definite dalle norme richiamate dalla specifica norma prodotto".

Alcune prove possono essere eseguite dal produttore stesso, secondo le disposizioni delle relative norme armonizzate, mentre altri requisiti sono di competenza di laboratori in possesso di una notifica attribuita loro dallo stato membro di appartenenza (organismi notificati).

***Il fabbricante può procedere in più modi:***

***eseguire autonomamente i test sui propri prodotti presso un istituto Notificato, diventando quindi titolare degli ITT***

***far riferimento ai risultati di prove effettuate dal detentore del sistema di serramento, purché quest'ultimo abbia espresso il proprio consenso per mezzo di un contratto di licenza d'uso stipulato tra le parti.***

Dal mese di Febbraio 2010 è obbligatoria la marcatura CE per finestre e porte pedonabili senza caratteristiche di resistenza al fuoco e tenuta al fumo.

L'appendice ZA della norma UNI EN 14351-1 specifica le caratteristiche essenziali per finestre e porte e attribuisce le competenze delle prove iniziali di tipo.

Per finestre e porte senza funzione di compartimentazione del fuoco o fumo e non poste nelle vie di fuga (sistema di attestazione della conformità 3):

Caratteristiche essenziali	Espressioni delle prestazioni	Competenza Prove Iniziali Tipo		
		ON =Organismo Notificato ; PR= Produttore		
		Finestre	Porte	Lucernari
Comportamento al fuoco dall'esterno				<b>ON</b>
Reazione al fuoco	Euroclassi			<b>ON</b>
Tenuta all'acqua	Classi tecniche	<b>ON</b>	<b>ON</b>	<b>ON</b>
Sostanze pericolose		<b>ON</b>	<b>ON</b>	
Resistenza al carico del vento	Classi tecniche	<b>ON</b>	<b>ON</b>	<b>PR</b>
Resistenza al carico della neve e al carico permanente	KN/mq			<b>PR</b>
Resistenza all'urto	Classi tecniche		<b>PR</b>	<b>ON</b>
Capacità portante dei dispositivi di sicurezza	Soglia	<b>ON</b>	<b>ON</b>	<b>ON</b>
Altezza	mm.		<b>PR</b>	
Forze di azionamento (solo dispositivi automatici)	Classi tecniche		<b>ON</b>	
Prestazione acustica	dB	<b>ON</b>	<b>ON</b>	<b>ON</b>
Trasmittanza termica	W/mqK	<b>ON</b>	<b>ON</b>	<b>ON</b>
Proprietà radioattive				<b>PR</b>
Permeabilità all'aria	Classi tecniche	<b>ON</b>	<b>ON</b>	<b>ON</b>



Il requisito relativo ad una determinata caratteristica non è applicabile in quegli Stati Membri nei quali non sussistono requisiti di regolamentazione per tale caratteristica per l'impiego previsto del prodotto. In questo caso, i fabbricanti che immettono i loro prodotti sul mercato di questi Stati membri non sono obbligati a determinare né a dichiarare le prestazioni dei loro prodotti in relazione a questa caratteristica e può essere utilizzata l'opzione "Nessuna Prestazione Determinata" (NPD) nelle informazioni che accompagnano la marcatura CE (vedere punto ZA.3). Tuttavia, l'opzione NPD non può essere utilizzata nel caso in cui la caratteristica sia soggetta a un livello soglia.

(Citazione integrale tratta dalla norma UNI EN 14351-1 - appendice ZA)

Pertanto, la valutazione delle caratteristiche da dichiarare è funzione della destinazione d'uso del prodotto e della legislazione vigente nello Stato Membro, ove esso è immesso.

## TEST INIZIALI DI TIPO EFFETTUATI SULLE FINESTRE

La serie riportata nel presente catalogo è stata sottoposta a test iniziali di tipo (ITT) relativamente ai requisiti previsti dalla norma prodotto UNI EN 14351-1

I risultati dei test iniziali di tipo sono estendibili a serramenti di differente tipologia e con differenti dimensioni e componenti, secondo le indicazioni fornite dalla norma EN 14351-1 in Appendice A (interdipendenza fra le caratteristiche e i componenti), Appendice E (determinazione delle caratteristiche) ed Appendice F (selezione facoltativa di provini rappresentativi per le finestre)

Il costruttore di serramenti ha la responsabilità di verificare la rispondenza del serramento prodotto rispetto al campione sottoposto a prova.

Il consorzio TWIN Systems mette a disposizione dei propri clienti i risultati dei test effettuati, a seguito della stipulazione di un contratto d'uso gratuito degli stessi.

### Dichiarazione di Conformità

Il fabbricante del serramento è tenuto a consegnare al committente una dichiarazione di conformità la quale, in accordo alla norma UNI EN 14351-1, deve includere :

Nome ed indirizzo del fabbricante o del suo rappresentante autorizzato con sede nella EEA;

Descrizione del prodotto (tipo, identificazione, impiego, ecc.) e una copia delle informazioni che accompagnano la marcatura CE;

Disposizioni alle quali il prodotto è conforme ( appendice AZ della norma prodotto UNI EN 14351-1);

Condizioni particolari applicabili all'impiego del prodotto (per esempio disposizioni per l'impiego in determinante condizioni, ecc.);

Nome e indirizzo del/i laboratorio/i approvato/i.

Nome e qualifica della persona incaricata di firmare la dichiarazione per conto del fabbricante o del suo rappresentante autorizzato.

La dichiarazione e il certificato devono essere presentati nella lingua o nelle lingue ufficiali dello Stato Membro in cui il prodotto deve essere utilizzato.

### Etichettatura e Marcatura

Il fabbricante deve fornire informazioni sufficienti ad assicurare la rintracciabilità del suo prodotto fornendo il collegamento fra il prodotto, il fabbricante e la produzione. Queste informazioni devono essere contenute su un'etichetta o specificate in documenti di accompagnamento nelle specifiche tecniche pubblicate dal fabbricante.

Le informazioni seguenti devono accompagnare il simbolo di marcatura CE:

Nome e indirizzo registrato o marchio di identificazione del fabbricante;

Ultime due cifre dell'anno in cui la marcatura CE è stata applicata;

Riferimento alla norma di prodotto (EN 14351-1);

Descrizione del prodotto: nome generico, materiale, dimensioni, ecc. e impiego previsto;

Informazioni sulle caratteristiche essenziali che devono essere dichiarate presentate come:

Valori dichiarati o livelli e/o classi;

NPD -" Nessuna prestazione determinata" per le caratteristiche quando è pertinente.

Il simbolo della marcatura CE e le informazioni di accompagnamento devono essere apposti in modo visibile, leggibile e indelebile in una o più delle posizioni seguenti (gerarchia di preferenza del fabbricante):

Qualsiasi parte idonea del prodotto stesso, purché sia assicurata la visibilità quando si aprono le ante;

Su un'etichetta attaccata;

Sul suo imballaggio;

Sul documento commerciale di accompagnamento.



### Documentazione Tecnica di Accompagnamento

Il fabbricante deve fornire informazioni su quanto segue:

Immagazzinaggio e movimentazione, se il fabbricante non è responsabile dell'installazione del prodotto;  
Requisiti e tecniche d'installazione (sul posto), se il fabbricante non è responsabile dell'installazione del prodotto (Guida UNCSAAL);

Manutenzione e pulizia (Manuale Consorzio TWIN SYSTEMS)

Istruzioni d'uso finali incluse le istruzioni per la sostituzione di componenti;

Istruzioni per l'uso in condizioni di sicurezza.

#### **In Italia i requisiti obbligatori per la Marcatura CE sono:**

Permeabilità dell'aria;

Trasmittanza termica;

Proprietà radiative (Fattore solare g, Trasmissione luminosa (TV)).

#### **In Spagna e in Portogallo i requisiti obbligatori per la Marcatura CE sono :**

Permeabilità all'aria;

Tenuta all'acqua;

Resistenza al vento;

Trasmittanza termica;

Isolamento acustico.

## TRASMITTANZA TERMICA DEI SERRAMENTI

E' necessario sapere che le prescrizioni dettate dal decreto ministeriale cambiano in funzione della tipologia di intervento edilizio (nuova costruzione, ristrutturazione importante di primo oppure secondo livello, riqualificazione energetica) e si applicano ad edifici sia pubblici sia privati.

Per edifici di **nuova costruzione** si intendono quei fabbricati il cui titolo abilitativo sia stato richiesto dopo l'entrata in vigore del decreto.

Sono **assimilati agli edifici di nuova costruzione** gli edifici sottoposti a **demolizione e ricostruzione**, qualunque sia il titolo abilitativo necessario, e gli ampliamenti di edifici esistenti la cui nuova porzione abbia un volume lordo climatizzato superiore al 15% di quello esistente o comunque superiore a 500 m<sup>3</sup>.

Per **interventi di ristrutturazione importante di primo livello** si intendono quelli che interessano l'involucro edilizio con un'incidenza superiore al 50 per cento della superficie disperdente lorda complessiva dell'edificio, comprendendo anche la ristrutturazione dell'impianto termico per il servizio di climatizzazione invernale e/o estiva asservito all'intero edificio.

Per **interventi di ristrutturazione importante di secondo livello** si intendono quelli che interessano l'involucro edilizio con un'incidenza superiore al 25 per cento della superficie disperdente lorda complessiva dell'edificio e possono interessare l'impianto termico per il servizio di climatizzazione invernale e/o estiva.

Negli **interventi di riqualificazione energetica** rientrano gli interventi non riconducibili agli interventi succitati e che hanno un impatto sulla prestazione energetica dell'edificio. Rientrano quindi anche:

- le ristrutturazioni che interessano l'involucro edilizio con un'incidenza inferiore o uguale al 25 per cento della superficie disperdente lorda complessiva dell'edificio e/o consistono nella nuova installazione, nella ristrutturazione di un impianto termico asservito all'edificio o di altri interventi parziali, ivi compresa la sostituzione del generatore;
- gli ampliamenti di edifici esistenti la cui nuova porzione abbia un volume lordo climatizzato inferiore o uguale al 15% di quello esistente o comunque inferiore a 500 m<sup>3</sup>.

Per gli edifici di nuova costruzione e per quelli sottoposti a ristrutturazioni di primo livello, non sono previsti specifici limiti di trasmittanza termica da rispettare per le chiusure trasparenti. Sussiste l'obbligo di rispettare limiti per quanto concerne altri parametri tecnici che connotano gli impianti, l'involucro edilizio e l'edificio nel loro complesso (per esempio coefficiente medio globale di scambio termico per trasmissione per unità di superficie disperdente HT' - area solare equivalente estiva per unità di superficie utile Asol,est/Asup utile - indice di prestazione termica utile per riscaldamento EPH,nd - indice di prestazione termica utile per il raffrescamento EPC,nd - indice di prestazione energetica globale dell'edificio EPgl,tot, ecc.) contenuti nell'Allegato A del decreto.











I limiti dell'Allegato A sul coefficiente medio globale di scambio termico per trasmissione per unità di superficie disperdente HT' sono da rispettare anche per gli interventi di ristrutturazione importante di secondo livello.

Nell'ambito degli **interventi di ristrutturazione importante di secondo livello e degli interventi di riqualificazione energetica** sono invece da rispettare i limiti riportati nell'**Appendice B** del decreto relativamente:

- alla **trasmissione termica  $U_w$  dei serramenti** (trasparenti, opachi) e dei **cassonetti** posti a delimitazione di ambienti climatizzati verso l'esterno oppure verso ambienti non climatizzati (cfr. **tabella 1**);
- al **fattore di trasmissione solare totale  $g_{gl+sh}$  dei serramenti vetriati in combinazione con schermature solari mobili** posizionati sui fronti dell'edificio SUD, EST, OVEST, SUD-EST, SUD-OVEST (cfr. **tabella 2**).

**Tabella 1 - Valori limite della trasmittanza  $U_w$  dei serramenti (trasparenti, opachi) e dei cassonetti posti a delimitazione di ambienti climatizzati verso l'esterno oppure verso ambienti non climatizzati.**

Zona climatica	$U_w$ (W/m <sup>2</sup> K)	
	2015 <sup>(1)</sup>	2021 <sup>(2)</sup>
 <b>A e B</b>	<b>3.20</b>	<b>3.00</b>
 <b>C</b>	<b>2.40</b>	<b>2.00</b>
 <b>D</b>	<b>2.10</b>	<b>1.80</b>
 <b>E</b>	<b>1.90</b>	<b>1.40</b>
 <b>F</b>	<b>1.70</b>	<b>1.00</b>

A partire dal 1° gennaio 2017, in merito all'accesso alle detrazioni del 65% per la riqualificazione energetica degli edifici, la regione **Lombardia** adotterà i valori limite di 1,4 W/m<sup>2</sup>K per la zona climatica E e 1,00 W/m<sup>2</sup>K per la zona climatica F.

Altre regioni da considerare :  
**Emilia Romagna**, dal 1° gennaio 2017 i valori di trasmittanza termica più severi valgono per gli edifici pubblici, nuovi e riqualificati;  
**Trentino Alto Adige**, dal 01/04/2017 per la "Trasmittanza termica U massima delle chiusure tecniche trasparenti e opache e dei cassonetti comprensive degli infissi, verso l'esterno e verso ambienti non climatizzati" sono previsti valori 1,4 e 1,0 W/m<sup>2</sup>K per la zona E e la F.

(1) dal 1 ottobre 2015 per tutti gli edifici

(2) dal 1 gennaio 2019 per gli edifici pubblici e a uso pubblico e dal 1 gennaio 2021 per tutti gli altri edifici

**Tabella 2 - Valori limite del fattore di trasmissione solare totale  $g_{gl+sh}$  chiusure trasparenti in presenza di schermature solari mobili installate su fronti dell'edificio SUD, EST, OVEST, SUD-EST, SUD-OVEST**

Zona climatica	$g_{gl+sh}$	
	2015 <sup>(1)</sup>	2021 <sup>(2)</sup>
<b>Tutte le zone</b>	<b>0.35</b>	<b>0.35</b>

(1) dal 1 ottobre 2015 per tutti gli edifici

(2) dal 1 gennaio 2019 per gli edifici pubblici e a uso pubblico e dal 1 gennaio 2021 per tutti gli altri edifici



### Valutazione della prestazione termica posseduta dai serramenti.

La trasmittanza termica rappresenta il parametro più significativo per la valutazione del comportamento termico di un prodotto edilizio: minore è il suo valore migliore è la prestazione termica posseduta dal componente stesso.

Il calcolo semplificato della trasmittanza termica del componente finestrato  $U_w$  composta da un singolo serramento e relativo vetro (o pannello) si esegue con la formula:

$$U_w = \frac{A_g U_g + A_f U_f + l g \varnothing g}{A_g + A_f}$$

dove:

**$A_g$**  è l'area del vetro in mq;

**$U_g$**  è il valore di trasmittanza termica riferito all'area centrale della vetrata, e non include l'effetto del distanziatore del vetro lungo il bordo della vetrata stessa;

**$A_f$**  è l'area del telaio;

**$U_f$**  è il valore di trasmittanza termica del telaio applicabile in assenza della vetrata;

**$l g$**  è la lunghezza del perimetro del vetro;

**$\varnothing g$**  è il valore di trasmittanza termica lineare concernente la conduzione di calore supplementare che avviene a causa dell'interazione tra telaio, vetri e distanziatore dei vetri in funzione delle proprietà termiche di ognuno di questi componenti e si rileva, secondo quanto precisato nell'allegato E della norma UNI EN ISO 10077-1, preferibilmente con il calcolo numerico eseguito in accordo con la norma ISO 10077-2; quando non sono disponibili i risultati di calcolo dettagliati ci si può riferire ai prospetti E.1 ed E.2 i quali indicano i valori  $\varnothing g$  di default per le tipiche combinazioni di telai, vetri e distanziatori.

### Estendibilità

L'appendice F della norma di prodotto UNI EN 14351-1 suggerisce le tipologie di serramento rappresentative e le relative estensioni, ma essendo la tabella puramente informativa, sta allo stesso produttore scegliere i campioni.

Tipo di finestre	Estensione possibile
Fisso	
Finestra ad una anta (apertura interna o esterna)	Finestra ad anta ribalta
Finestra ad anta ribalta	
Finestra ad due o più ante (apertura interna o esterna)	Finestra ad due o più ante
Finestra a una o due ante orizzontali scorrevoli	
Finestra a due ante orizzontali scorrevoli	Finestra a due ante orizzontali scorrevoli
Finestra a una o due ante orizzontali scorrevoli con ribalta	Finestra a una o due ante orizzontali scorrevoli con ribalta
Bilico orizzontale o verticale	Bilico orizzontale o verticale
Finestra a soffietto	Finestra a soffietto

La norma UNI EN 14351-1 prevede che il calcolo effettuato su di un serramento aventi dimensioni:

1230 ( $\pm 25\%$ ) x 1480 ( $-25\%$ )

1480 ( $+25\%$ ) x 2180 ( $\pm 25\%$ )

Le analisi termiche effettuate con le misure sopra descritte, possono essere estese a tutti i serramenti di tutte le dimensioni, purché il vetro utilizzato abbia come valore di  $U_g$  uguale o inferiore a  $1.9 \text{ w/m}^2\text{K}$ , altrimenti la norma delle regole di estensione dei valori calcolati sull'infisso normalizzato ad infissi di diverse dimensioni.

Ovviamente i calcoli devono essere effettuati sulle stesse tipologie di infissi, e s'intende che una modifica del componente modifica la caratteristica in questione. In termini di prestazioni termiche è ovvio che andando a togliere o ad aggiungere elementi (per esempio passare da una finestra ad una anta, ad una a due e così via), determina una variazione dei valori finali.



Diagramma dei limiti di impiego per infissi a 2 ante deflessione del nodo centrale

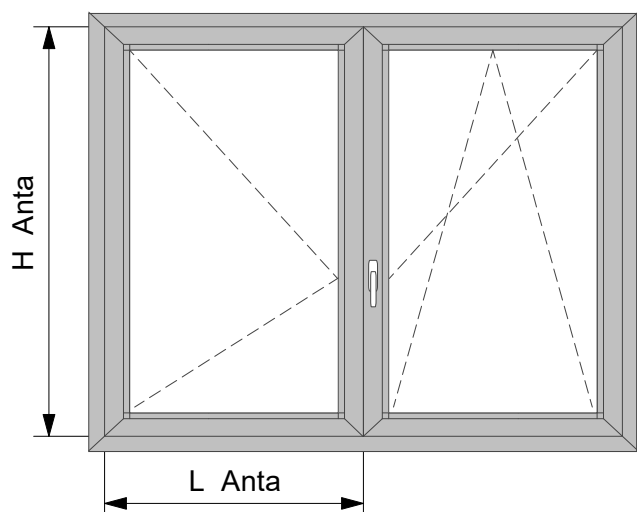
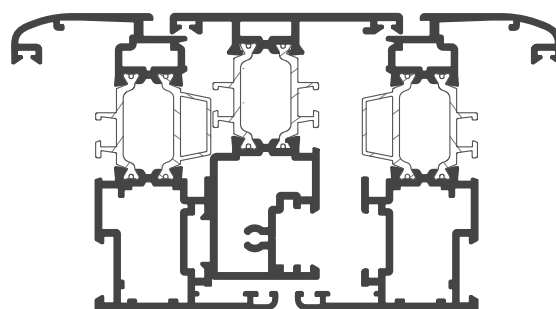
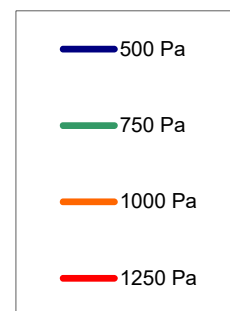
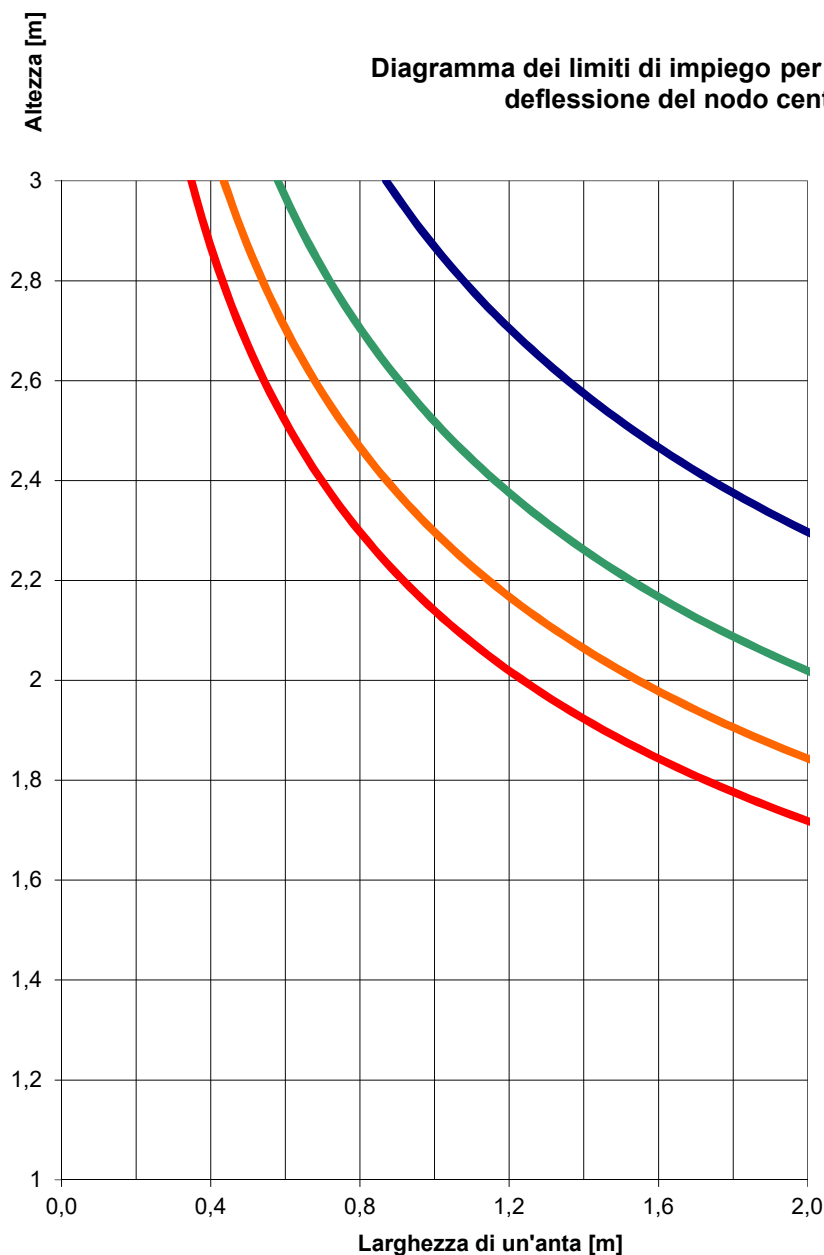

Il dimensionamento risultante dal grafico è solo indicativo.

Il progettista o il serramentista, nel determinare le dimensioni massime dei serramenti, dovrà considerare e valutare, oltre le dimensioni ed il momento d'inerzia dei profilati, anche le caratteristiche applicative e meteorologiche quali l'altezza dal suolo, l'esposizione alla pioggia e la velocità dei venti nella zona. Per questi dati consigliamo di consultare e seguire le "Raccomandazioni UNCSAAL" elaborate sulla base delle norme UNI, UNI-EN e UNI-CNR esistenti in merito.

Verificare che la freccia del profilato sia compatibile con quella del vetro utilizzato. Le curve rappresentano la larghezza massima dell'anta in funzione della sua altezza e della pressione del vento. Il serramento è considerato a 2 ante uguali. Le curve sono calcolate sulla base della deformazione elastica di **1/300** dell'altezza del serramento.



Altezza [m] **Diagramma dei limiti di impiego per infissi a 2 ante deflessione del nodo centrale**

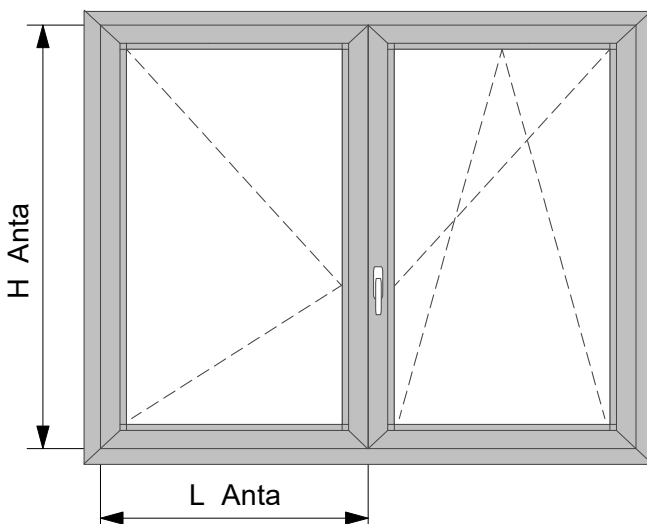
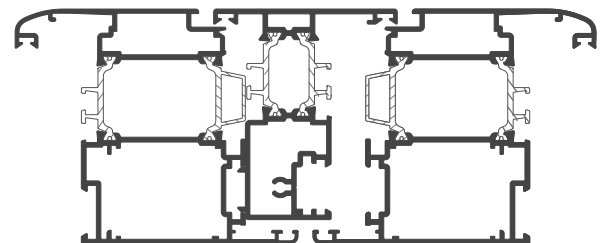
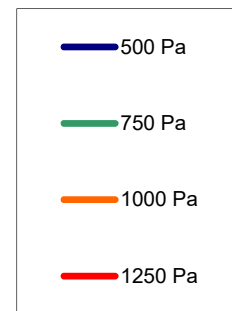
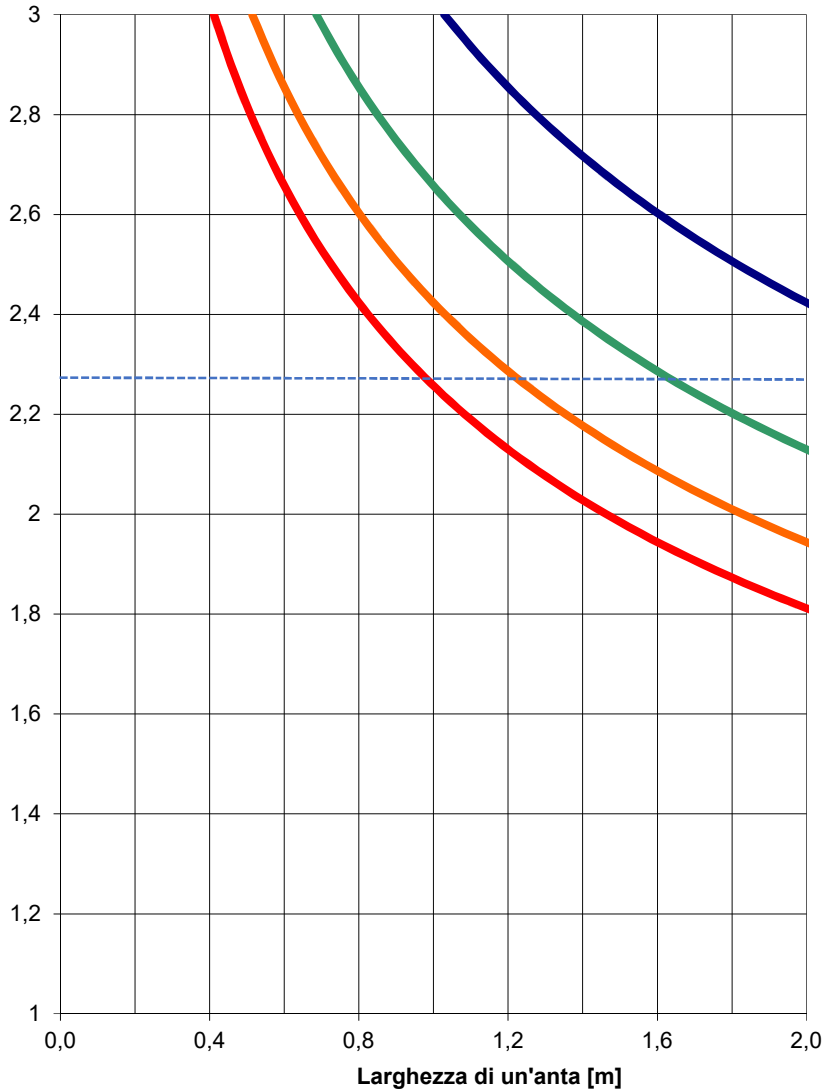

Il dimensionamento risultante dal grafico è solo indicativo.

Il progettista o il serramentista, nel determinare le dimensioni massime dei serramenti, dovrà considerare e valutare, oltre le dimensioni ed il momento d'inerzia dei profilati, anche le caratteristiche applicative e meteorologiche quali l'altezza dal suolo, l'esposizione alla pioggia e la velocità dei venti nella zona. Per questi dati consigliamo di consultare e seguire le "Raccomandazioni UNCSAAL" elaborate sulla base delle norme UNI, UNI-EN e UNI-CNR esistenti in merito.

Verificare che la freccia del profilato sia compatibile con quella del vetro utilizzato.  
Le curve rappresentano la larghezza massima dell'anta in funzione della sua altezza e della pressione del vento.  
Il serramento è considerato a 2 ante uguali.  
Le curve sono calcolate sulla base della deformazione elastica di **1/300** dell'altezza del serramento.



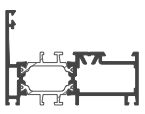
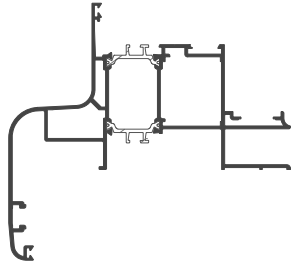
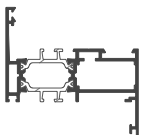
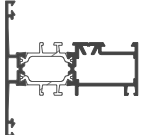
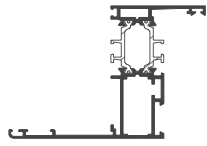
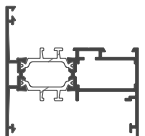
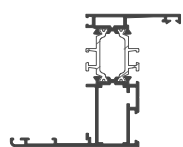
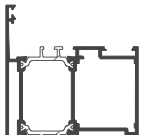
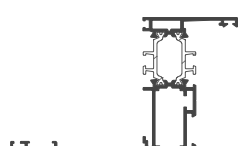
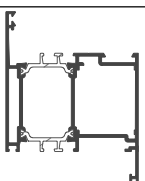
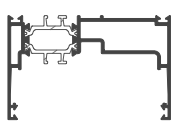
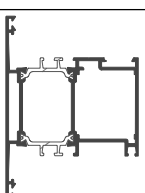
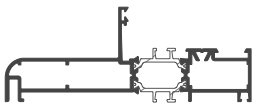
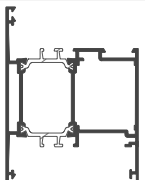
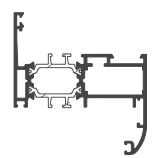

<b>CX70.101</b> Telaio ad L piccolo <b>Peso</b> kg/ml. <b>1.287</b> <b>Jx</b> 24.98 cm <sup>4</sup> <b>Wx</b> 6.61 cm <sup>3</sup> <b>Jy</b> 5.28 cm <sup>4</sup> <b>Wy</b> 1.64 cm <sup>3</sup>		Tavola 10	<b>CX70.109</b> Telaio per capannoni <b>Peso</b> kg/ml. <b>3.013</b> <b>Jx</b> 200.60 cm <sup>4</sup> <b>Wx</b> 23.57 cm <sup>3</sup> <b>Jy</b> 85.16 cm <sup>4</sup> <b>Wy</b> 11.55 cm <sup>3</sup>		Tavola 35
<b>CX70.102</b> Telaio a Z piccolo <b>Peso</b> kg/ml. <b>1.366</b> <b>Jx</b> 29.80 cm <sup>4</sup> <b>Wx</b> 8.44 cm <sup>3</sup> <b>Jy</b> 8.40 cm <sup>4</sup> <b>Wy</b> 2.28 cm <sup>3</sup>		Tavola 10			
<b>CX70.103</b> Telaio a T piccolo <b>Peso</b> kg/ml. <b>1.401</b> <b>Jx</b> 28.59 cm <sup>4</sup> <b>Wx</b> 7.03 cm <sup>3</sup> <b>Jy</b> 8.96 cm <sup>4</sup> <b>Wy</b> 2.43 cm <sup>3</sup>		Tavola 10	<b>CX70.110</b> Telaio a Z aletta battuta 54 mm. <b>Peso</b> kg/ml. <b>1.520</b> <b>Jx</b> 35.50 cm <sup>4</sup> <b>Wx</b> 9.04 cm <sup>3</sup> <b>Jy</b> 23,22 cm <sup>4</sup> <b>Wy</b> 3,71 cm <sup>3</sup>		Tavola 12
<b>CX70.104</b> Telaio ad h piccolo-soglia <b>Peso</b> kg/ml. <b>1.480</b> <b>Jx</b> 34.19 cm <sup>4</sup> <b>Wx</b> 9.08 cm <sup>3</sup> <b>Jy</b> 11.46 cm <sup>4</sup> <b>Wy</b> 3.05 cm <sup>3</sup>		Tavola 10	<b>CX70.111</b> Telaio a Z aletta battuta 40 mm. <b>Peso</b> kg/ml. <b>1.459</b> <b>Jx</b> 33.39 cm <sup>4</sup> <b>Wx</b> 8.83 cm <sup>3</sup> <b>Jy</b> 15,00 cm <sup>4</sup> <b>Wy</b> 2,91 cm <sup>3</sup>		Tavola 12
<b>CX70.105</b> Telaio ad L grande <b>Peso</b> kg/ml. <b>1.681</b> <b>Jx</b> 35.96 cm <sup>4</sup> <b>Wx</b> 9.31 cm <sup>3</sup> <b>Jy</b> 20.35 cm <sup>4</sup> <b>Wy</b> 4.58 cm <sup>3</sup>		Tavola 11	<b>CX70.112</b> Telaio a Z aletta battuta 70 mm. <b>Peso</b> kg/ml. <b>1.615</b> <b>Jx</b> 41.05 cm <sup>4</sup> <b>Wx</b> 9.58 cm <sup>3</sup> <b>Jy</b> 37.52 cm <sup>4</sup> <b>Wy</b> 5,05 cm <sup>3</sup>		Tavola 12
<b>CX70.106</b> Telaio a Z grande <b>Peso</b> kg/ml. <b>1.791</b> <b>Jx</b> 41.82 cm <sup>4</sup> <b>Wx</b> 11.43 cm <sup>3</sup> <b>Jy</b> 26.76 cm <sup>4</sup> <b>Wy</b> 5.49 cm <sup>3</sup>		Tavola 11	<b>XX70.113</b> Telaio di compensazione <b>Peso</b> kg/ml. <b>1.542</b> <b>Jx</b> 53.42 cm <sup>4</sup> <b>Wx</b> 12.40 cm <sup>3</sup> <b>Jy</b> 10,98 cm <sup>4</sup> <b>Wy</b> 3,04 cm <sup>3</sup>		Tavola 12
<b>CX70.107</b> Telaio a T grande <b>Peso</b> kg/ml. <b>1.788</b> <b>Jx</b> 38.46 cm <sup>4</sup> <b>Wx</b> 9.69 cm <sup>3</sup> <b>Jy</b> 27.36 cm <sup>4</sup> <b>Wy</b> 5.62 cm <sup>3</sup>		Tavola 11	<b>CX70.116</b> Semi-Pilastrino <b>Peso</b> kg/ml. <b>1.880</b> <b>Jx</b> 00.00 cm <sup>4</sup> <b>Wx</b> 00.00 cm <sup>3</sup> <b>Jy</b> 00.00 cm <sup>4</sup> <b>Wy</b> 00.00 cm <sup>3</sup>		Tavola 14
<b>CX70.108</b> Telaio ad h grande <b>Peso</b> kg/ml. <b>1.898</b> <b>Jx</b> 45.35 cm <sup>4</sup> <b>Wx</b> 11.88 cm <sup>3</sup> <b>Jy</b> 32.93 cm <sup>4</sup> <b>Wy</b> 6.61 cm <sup>3</sup>		Tavola 11	<b>CX70.117</b> Telaio Z piccolo rientro m.11.5 <b>Peso</b> kg/ml. <b>1.430</b> <b>Jx</b> 29.98 cm <sup>4</sup> <b>Wx</b> 7.71 cm <sup>3</sup> <b>Jy</b> 9.81 cm <sup>4</sup> <b>Wy</b> 2.54 cm <sup>3</sup>		Tavola 14

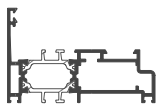
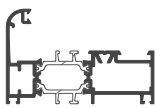
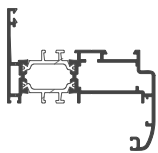
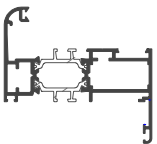
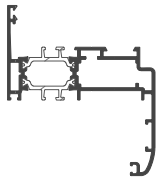
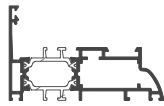
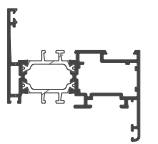
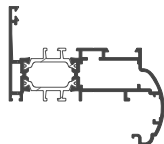
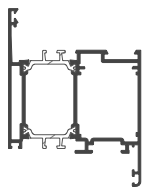
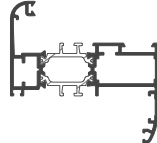
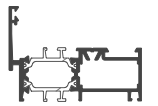
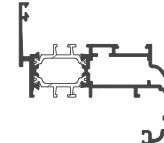
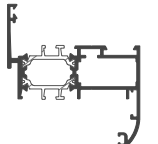
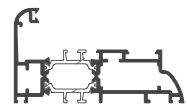
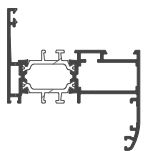
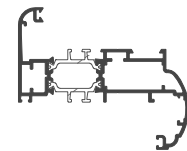

<b>CX70.119</b> Tel. a L complanare piccolo <b>Peso</b> kg/ml. <b>1.273</b> <b>Jx</b> 30.03 cm <sup>4</sup> <b>Wx</b> 5.40 cm <sup>3</sup> <b>Jy</b> 7.00 cm <sup>4</sup> <b>Wy</b> 1.64 cm <sup>3</sup>		Tavola 15	<b>CX70.152</b> Telaio bombato ad L piccolo <b>Peso</b> kg/ml. <b>1.433</b> <b>Jx</b> 34.86 cm <sup>4</sup> <b>Wx</b> 10.56 cm <sup>3</sup> <b>Jy</b> 8.99 cm <sup>4</sup> <b>Wy</b> 3.42 cm <sup>3</sup>		Tavola 16
<b>CX70.120</b> Tel. Z compl. picc. aletta 25 mm <b>Peso</b> kg/ml. <b>1.447</b> <b>Jx</b> 38.96 cm <sup>4</sup> <b>Wx</b> 11.61 cm <sup>3</sup> <b>Jy</b> 9.75 cm <sup>4</sup> <b>Wy</b> 3.08 cm <sup>3</sup>		Tavola 15	<b>CX70.153</b> Telaio bombato a Z piccolo <b>Peso</b> kg/ml. <b>1.512</b> <b>Jx</b> 42.01 cm <sup>4</sup> <b>Wx</b> 11.98 cm <sup>3</sup> <b>Jy</b> 15.78 cm <sup>4</sup> <b>Wy</b> 4.61 cm <sup>3</sup>		Tavola 16
<b>CX70.121</b> Tel. Z compl. picc. aletta 40 mm <b>Peso</b> kg/ml. <b>1.529</b> <b>Jx</b> 42.78 cm <sup>4</sup> <b>Wx</b> 10.15 cm <sup>3</sup> <b>Jy</b> 19.40 cm <sup>4</sup> <b>Wy</b> 3.91 cm <sup>3</sup>		Tavola 15	<b>CX70.155</b> Tel. a L ornamentale piccolo <b>Peso</b> kg/ml. <b>1.307</b> <b>Jx</b> 32.19 cm <sup>4</sup> <b>Wx</b> 5.71 cm <sup>3</sup> <b>Jy</b> 6.99 cm <sup>4</sup> <b>Wy</b> 1.70 cm <sup>3</sup>		Tavola 13
<b>CX70.122</b> Telaio / anta piccolo <b>Peso</b> kg/ml. <b>1.417</b> <b>Jx</b> 29.86 cm <sup>4</sup> <b>Wx</b> 8.41 cm <sup>3</sup> <b>Jy</b> 8.62 cm <sup>4</sup> <b>Wy</b> 2.41 cm <sup>3</sup>		Tavola 15	<b>CX70.156</b> Tel. Z ornam. picc. aletta 25 mm <b>Peso</b> kg/ml. <b>1.484</b> <b>Jx</b> 41.23 cm <sup>4</sup> <b>Wx</b> 12.06 cm <sup>3</sup> <b>Jy</b> 10.05 cm <sup>4</sup> <b>Wy</b> 3.21 cm <sup>3</sup>		Tavola 13
<b>CX70.123</b> Telaio / anta grande <b>Peso</b> kg/ml. <b>1.831</b> <b>Jx</b> 41.45 cm <sup>4</sup> <b>Wx</b> 11.56 cm <sup>3</sup> <b>Jy</b> 28.05 cm <sup>4</sup> <b>Wy</b> 5.84 cm <sup>3</sup>		Tavola 15	<b>CX70.157</b> Telaio bombato a Z rientrato picc. <b>Peso</b> kg/ml. <b>1.547</b> <b>Jx</b> 42.89 cm <sup>4</sup> <b>Wx</b> 12.66 cm <sup>3</sup> <b>Jy</b> 18.73 cm <sup>4</sup> <b>Wy</b> 5.44 cm <sup>3</sup>		Tavola 16
<b>CX70.124</b> Telaio a L piccolo ridotto <b>Peso</b> kg/ml. <b>1.212</b> <b>Jx</b> 23.57 cm <sup>4</sup> <b>Wx</b> 6.39 cm <sup>3</sup> <b>Jy</b> 5.00 cm <sup>4</sup> <b>Wy</b> 1.53 cm <sup>3</sup>		Tavola 14	<b>CX70.160</b> Telaio bombato a Z rientrato picc. <b>Peso</b> kg/ml. <b>1.501</b> <b>Jx</b> 38.41 cm <sup>4</sup> <b>Wx</b> 9.07 cm <sup>3</sup> <b>Jy</b> 11.96 cm <sup>4</sup> <b>Wy</b> 3.17 cm <sup>3</sup>		Tavola 17
<b>CX70.125</b> Tel Z picc.ridotto rientro mm.11.5 <b>Peso</b> kg/ml. <b>1.355</b> <b>Jx</b> 29.55 cm <sup>4</sup> <b>Wx</b> 7.86 cm <sup>3</sup> <b>Jy</b> 10.08 cm <sup>4</sup> <b>Wy</b> 2.83 cm <sup>3</sup>		Tavola 14	<b>CX70.161</b> Telaio bombato a Z rientrato picc. <b>Peso</b> kg/ml. <b>1.453</b> <b>Jx</b> 41.91 cm <sup>4</sup> <b>Wx</b> 8.19 cm <sup>3</sup> <b>Jy</b> 7.33 cm <sup>4</sup> <b>Wy</b> 2.27 cm <sup>3</sup>		Tavola 17
<b>CX70.127</b> Tel. Z picc.ridotto rientro mm.8 <b>Peso</b> kg/ml. <b>1.401</b> <b>Jx</b> 31.43 cm <sup>4</sup> <b>Wx</b> 8.59 cm <sup>3</sup> <b>Jy</b> 10.97 cm <sup>4</sup> <b>Wy</b> 2.88 cm <sup>3</sup>		Tavola 21	<b>CX70.162</b> Telaio bombato a Z rientrato picc. <b>Peso</b> kg/ml. <b>1.630</b> <b>Jx</b> 53.33 cm <sup>4</sup> <b>Wx</b> 11.72 cm <sup>3</sup> <b>Jy</b> 14.27 cm <sup>4</sup> <b>Wy</b> 3.73 cm <sup>3</sup>		Tavola 17

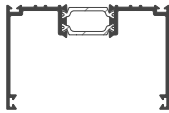
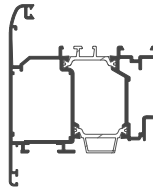
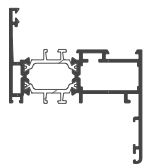
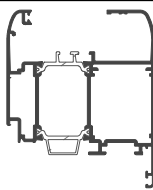
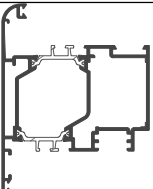
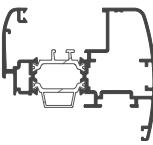
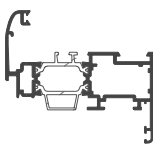
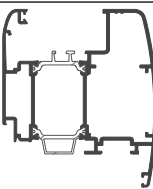
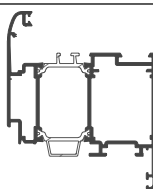
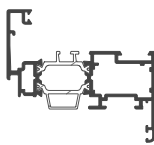
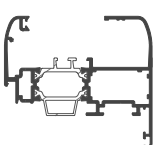
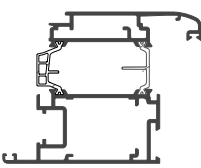
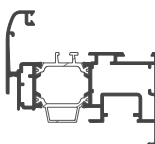
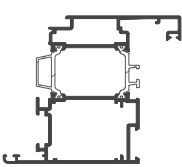

<b>XX70.163</b> Telaio compensazione <b>Peso</b> kg/ml. <b>1.256</b> <b>Jx</b> 46.13 cm <sup>4</sup> <b>Wx</b> 10.72 cm <sup>3</sup> <b>Jy</b> 11.20 cm <sup>4</sup> <b>Wy</b> 3.08 cm <sup>3</sup>		Tavola 16	<b>CX70.205</b> Anta apertura esterna <b>Peso</b> kg/ml. <b>2.039</b> <b>Jx</b> 52.27 cm <sup>4</sup> <b>Wx</b> 12.09 cm <sup>3</sup> <b>Jy</b> 33.26 cm <sup>4</sup> <b>Wy</b> 6.87 cm <sup>3</sup>		Tavola 23 9
<b>CX70.172</b> Telaio a Z aletta battuta 32 mm. <b>Peso</b> kg/ml. <b>1.424</b> <b>Jx</b> 31.11 cm <sup>4</sup> <b>Wx</b> 8.26 cm <sup>3</sup> <b>Jy</b> 11.98 cm <sup>4</sup> <b>Wy</b> 2.67 cm <sup>3</sup>		Tavola 13	<b>CX70.206</b> Anta tonda grande v/infilare <b>Peso</b> kg/ml. <b>2.090</b> <b>Jx</b> 56.75 cm <sup>4</sup> <b>Wx</b> 13.79 cm <sup>3</sup> <b>Jy</b> 39.71 cm <sup>4</sup> <b>Wy</b> 7.83 cm <sup>3</sup>		Tavola 19
			<b>CX70.207</b> Anta apertura bilico <b>Peso</b> kg/ml. <b>2.086</b> <b>Jx</b> 54.02 cm <sup>4</sup> <b>Wx</b> 11.88 cm <sup>3</sup> <b>Jy</b> 37.93 cm <sup>4</sup> <b>Wy</b> 7.45 cm <sup>3</sup>		Tavola 29
			<b>CX70.209</b> Anta piccola ellittica v/infilare <b>Peso</b> kg/ml. <b>1.695</b> <b>Jx</b> 00.00 cm <sup>4</sup> <b>Wx</b> 00.00 cm <sup>3</sup> <b>Jy</b> 00.00 cm <sup>4</sup> <b>Wy</b> 00.00 cm <sup>3</sup>		Tavola 19
<b>CX70.201</b> Anta tonda piccola c/fermavetro <b>Peso</b> kg/ml. <b>1.528</b> <b>Jx</b> 37.73 cm <sup>4</sup> <b>Wx</b> 9.46 cm <sup>3</sup> <b>Jy</b> 9.96 cm <sup>4</sup> <b>Wy</b> 2.80 cm <sup>3</sup>		Tavola 18	<b>CX70.210</b> Anta grande ellittica v/infilare <b>Peso</b> kg/ml. <b>2.19</b> <b>Jx</b> 00.00 cm <sup>4</sup> <b>Wx</b> 00.00 cm <sup>3</sup> <b>Jy</b> 00.00 cm <sup>4</sup> <b>Wy</b> 00.00 cm <sup>3</sup>		Tavola 17 9
<b>CX70.202</b> Anta tonda grande c/fermavetro <b>Peso</b> kg/ml. <b>1.956</b> <b>Jx</b> 51.50 cm <sup>4</sup> <b>Wx</b> 13.13 cm <sup>3</sup> <b>Jy</b> 31.00 cm <sup>4</sup> <b>Wy</b> 6.51 cm <sup>3</sup>		Tavola 18	<b>CX70.215</b> Anta diritta piccola c/fermavetro <b>Peso</b> kg/ml. <b>1.549</b> <b>Jx</b> 00.00 cm <sup>4</sup> <b>Wx</b> 00.00 cm <sup>3</sup> <b>Jy</b> 00.00 cm <sup>4</sup> <b>Wy</b> 00.00 cm <sup>3</sup>		Tavola 21
<b>CX70.203</b> Anta tonda piccola v/infilare <b>Peso</b> kg/ml. <b>1.650</b> <b>Jx</b> 42.53 cm <sup>4</sup> <b>Wx</b> 9.93 cm <sup>3</sup> <b>Jy</b> 14.47 cm <sup>4</sup> <b>Wy</b> 3.76 cm <sup>3</sup>		Tavola 19	<b>CX70.225</b> Anta tonda grande f/nastro <b>Peso</b> kg/ml. <b>2.437</b> <b>Jx</b> 53.11 cm <sup>4</sup> <b>Wx</b> 20.35 cm <sup>3</sup> <b>Jy</b> 26.22 cm <sup>4</sup> <b>Wy</b> 7.88 cm <sup>3</sup>		Tavola 24
<b>CX70.204</b> Anta tonda piccola f/nastro <b>Peso</b> kg/ml. <b>1.789</b> <b>Jx</b> 47.57 cm <sup>4</sup> <b>Wx</b> 11.87 cm <sup>3</sup> <b>Jy</b> 14.63 cm <sup>4</sup> <b>Wy</b> 3.71 cm <sup>3</sup>		Tavola 23	<b>CX70.226</b> Anta diritta grande c/fermavetro <b>Peso</b> kg/ml. <b>1.974</b> <b>Jx</b> 00.00 cm <sup>4</sup> <b>Wx</b> 00.00 cm <sup>3</sup> <b>Jy</b> 00.00 cm <sup>4</sup> <b>Wy</b> 00.00 cm <sup>3</sup>		Tavola 21



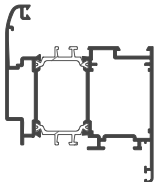
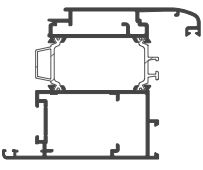
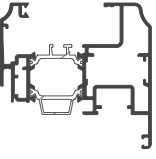
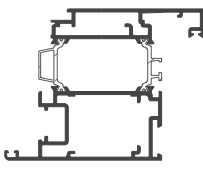
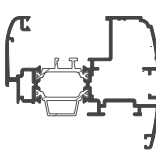
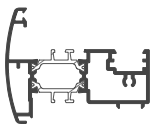
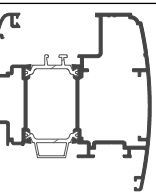
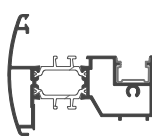
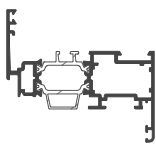
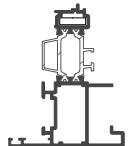
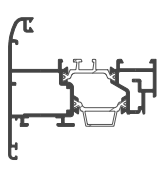
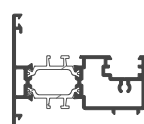
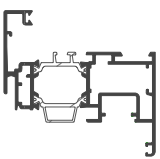
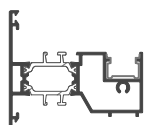
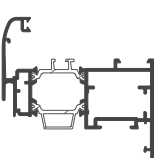
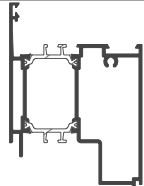

<b>CX70.227</b> Anta doppia battuta grande <b>Peso</b> kg/ml. <b>1.953</b> <b>Jx</b> 51.47 cm <sup>4</sup> <b>Wx</b> 15.03 cm <sup>3</sup> <b>Jy</b> 32.33 cm <sup>4</sup> <b>Wy</b> 6.41 cm <sup>3</sup>		Tavola 22	<b>CX70.261</b> Anta grande sormonto int. 10 mm <b>Peso</b> kg/ml. <b>2.307</b> <b>Jx</b> 67.58 cm <sup>4</sup> <b>Wx</b> 16.25 cm <sup>3</sup> <b>Jy</b> 49.62 cm <sup>4</sup> <b>Wy</b> 9.45 cm <sup>3</sup>		Tavola 25
<b>XX70.230</b> Anta ornamentale ferr.nastro <b>Peso</b> kg/ml. <b>1.990</b> <b>Jx</b> 38.99 cm <sup>4</sup> <b>Wx</b> 10.63 cm <sup>3</sup> <b>Jy</b> 22.31 cm <sup>4</sup> <b>Wy</b> 5.17 cm <sup>3</sup>		Tavola 23	<b>CX70.262</b> Anta dritta grande f/nastro <b>Peso</b> kg/ml. <b>2.462</b> <b>Jx</b> 53.66 cm <sup>4</sup> <b>Wx</b> 20.41 cm <sup>3</sup> <b>Jy</b> 26.75 cm <sup>4</sup> <b>Wy</b> 7.96 cm <sup>3</sup>		Tavola 24
<b>CX70.232</b> Anta picc. ornamentale v/infilare <b>Peso</b> kg/ml. <b>1.699</b> <b>Jx</b> 00.00 cm <sup>4</sup> <b>Wx</b> 00.00 cm <sup>3</sup> <b>Jy</b> 00.00 cm <sup>4</sup> <b>Wy</b> 00.00 cm <sup>3</sup>		Tavola 20	<b>CX70.301</b> Riporto tondo <b>Peso</b> kg/ml. <b>1.471</b> <b>Jx</b> 33.71 cm <sup>4</sup> <b>Wx</b> 8.34 cm <sup>3</sup> <b>Jy</b> 8.21 cm <sup>4</sup> <b>Wy</b> 2.33 cm <sup>3</sup>		Tavola 18
<b>CX70.233</b> Anta grande ornamen. v/infilare <b>Peso</b> kg/ml. <b>2.184</b> <b>Jx</b> 00.00 cm <sup>4</sup> <b>Wx</b> 00.00 cm <sup>3</sup> <b>Jy</b> 00.00 cm <sup>4</sup> <b>Wy</b> 00.00 cm <sup>3</sup>		Tavola 20	<b>XX70.302</b> Riporto tondo f/nastro <b>Peso</b> kg/ml. <b>1.462</b> <b>Jx</b> 34.52 cm <sup>4</sup> <b>Wx</b> 8.33 cm <sup>3</sup> <b>Jy</b> 9.49 cm <sup>4</sup> <b>Wy</b> 2.59 cm <sup>3</sup>		Tavola 23
<b>CX70.235</b> Anta dritta rientro 5 mm. <b>Peso</b> kg/ml. <b>1.487</b> <b>Jx</b> 00.00 cm <sup>4</sup> <b>Wx</b> 00.00 cm <sup>3</sup> <b>Jy</b> 00.00 cm <sup>4</sup> <b>Wy</b> 00.00 cm <sup>3</sup>		Tavola 22	<b>CX70.303</b> Riporto/inversione bilico <b>Peso</b> kg/ml. <b>1.367</b> <b>Jx</b> 26.05 cm <sup>4</sup> <b>Wx</b> 5.51 mm <sup>3</sup> <b>Jy</b> 6.92 cm <sup>4</sup> <b>Wy</b> 2.10 mm <sup>3</sup>		Tavola 31
<b>CX70.237</b> Anta piccola apertura esterna <b>Peso</b> kg/ml. <b>1.691</b> <b>Jx</b> 40.38 cm <sup>4</sup> <b>Wx</b> 8.97 cm <sup>3</sup> <b>Jy</b> 13.21 cm <sup>4</sup> <b>Wy</b> 3.51 cm <sup>3</sup>		Tavola 24	<b>CX70.304</b> Riporto dritto <b>Peso</b> kg/ml. <b>1.405</b> <b>Jx</b> 00.00 cm <sup>4</sup> <b>Wx</b> 00.00 cm <sup>3</sup> <b>Jy</b> 00.00 cm <sup>4</sup> <b>Wy</b> 00.00 cm <sup>3</sup>		Tavola 18
<b>CX70.238</b> Anta dritta piccola f/nastro <b>Peso</b> kg/ml. <b>1.802</b> <b>Jx</b> 48.70 cm <sup>4</sup> <b>Wx</b> 12.03 cm <sup>3</sup> <b>Jy</b> 15.54 cm <sup>4</sup> <b>Wy</b> 3.89 cm <sup>3</sup>		Tavola 24	<b>XX70.308</b> Riporto dritto f/nastro <b>Peso</b> kg/ml. <b>1.409</b> <b>Jx</b> 30.62 cm <sup>4</sup> <b>Wx</b> 7.81 cm <sup>3</sup> <b>Jy</b> 8.50 cm <sup>4</sup> <b>Wy</b> 2.35 cm <sup>3</sup>		Tavola 23
<b>CX70.260</b> Anta piccola sormonto int. 10 mm <b>Peso</b> kg/ml. <b>1.760</b> <b>Jx</b> 48.68 cm <sup>4</sup> <b>Wx</b> 12.13 cm <sup>3</sup> <b>Jy</b> 14.97 cm <sup>4</sup> <b>Wy</b> 3.90 cm <sup>3</sup>		Tavola 25	<b>CX70.401</b> Soprazoccolo <b>Peso</b> kg/ml. <b>1.971</b> <b>Jx</b> 41.99 cm <sup>4</sup> <b>Wx</b> 11.96 mm <sup>3</sup> <b>Jy</b> 39.08 cm <sup>4</sup> <b>Wy</b> 7.72 mm <sup>3</sup>		Tavola 27



<b>CX70.402</b> Traverso mm.96 <b>Peso</b> kg/ml. <b>2.066</b> <b>Jx</b> 43.81 cm <sup>4</sup> <b>Wx</b> 11.08 mm <sup>3</sup> <b>Jy</b> 31.45 cm <sup>4</sup> <b>Wy</b> 6.55 mm <sup>3</sup>		Tavola 27	<b>XX70.414</b> Soglia bassa per porte <b>Peso</b> kg/ml. <b>0.966</b> <b>Jx</b> 00.00 cm <sup>4</sup> <b>Wx</b> 00.00 cm <sup>3</sup> <b>Jy</b> 00.00 cm <sup>4</sup> <b>Wy</b> 00.00 cm <sup>3</sup>		Tavola 28
<b>CX70.403</b> Fascia mm. 158 <b>Peso</b> kg/ml. <b>3.174</b> <b>Jx</b> 73.53 cm <sup>4</sup> <b>Wx</b> 18.10 cm <sup>3</sup> <b>Jy</b> 190.58 cm <sup>4</sup> <b>Wy</b> 24.12 cm <sup>3</sup>		Tavola 28	<b>CX70.415</b> Fascia compl. da 78 x 158 mm. <b>Peso</b> kg/ml. <b>3.298</b> <b>Jx</b> 00.00 cm <sup>4</sup> <b>Wx</b> 0.00 cm <sup>3</sup> <b>Jy</b> 00.00 cm <sup>4</sup> <b>Wy</b> 0.00 cm <sup>3</sup>		Tavola 22
<b>CX70.404</b> Zoccolo mm. 158 <b>Peso</b> kg/ml. <b>3.284</b> <b>Jx</b> 79.47 cm <sup>4</sup> <b>Wx</b> 20.25 cm <sup>3</sup> <b>Jy</b> 212.70 cm <sup>4</sup> <b>Wy</b> 25.47 cm <sup>3</sup>		Tavola 28			
<b>XX70.405</b> Traverso v/infilare mm. 96 <b>Peso</b> kg/ml. <b>1.729</b> <b>Jx</b> 20.40 cm <sup>4</sup> <b>Wx</b> 5.66 cm <sup>3</sup> <b>Jy</b> 31.96 cm <sup>4</sup> <b>Wy</b> 9.41 cm <sup>3</sup>		Tavola 26	<b>CX70.521</b> Fermavetro tondo mm. 14 <b>Peso</b> kg/ml. <b>0.266</b> <b>Jx</b> 00.00 cm <sup>4</sup> <b>Wx</b> 00.00 cm <sup>3</sup> <b>Jy</b> 00.00 cm <sup>4</sup> <b>Wy</b> 00.00 cm <sup>3</sup>		Tavola 38
<b>XX70.406</b> Traverso v/infilare mm. 158 <b>Peso</b> kg/ml. <b>3.352</b> <b>Jx</b> 70.30 cm <sup>4</sup> <b>Wx</b> 20.98 cm <sup>3</sup> <b>Jy</b> 231.32 cm <sup>4</sup> <b>Wy</b> 29.28 cm <sup>3</sup>		Tavola 26	<b>CX70.522</b> Fermavetro tondo mm. 18 <b>Peso</b> kg/ml. <b>0.277</b> <b>Jx</b> 00.00 cm <sup>4</sup> <b>Wx</b> 00.00 cm <sup>3</sup> <b>Jy</b> 00.00 cm <sup>4</sup> <b>Wy</b> 00.00 cm <sup>3</sup>		Tavola 38
<b>XX70.407</b> Soprazoccolo v/infilare mm. 74 <b>Peso</b> kg/ml. <b>1.884</b> <b>Jx</b> 33.98 cm <sup>4</sup> <b>Wx</b> 10.92 cm <sup>3</sup> <b>Jy</b> 30.61 cm <sup>4</sup> <b>Wy</b> 7.44 cm <sup>3</sup>		Tavola 26	<b>CX70.523</b> Fermavetro tondo mm. 22 <b>Peso</b> kg/ml. <b>0.294</b> <b>Jx</b> 00.00 cm <sup>4</sup> <b>Wx</b> 00.00 cm <sup>3</sup> <b>Jy</b> 00.00 cm <sup>4</sup> <b>Wy</b> 00.00 cm <sup>3</sup>		Tavola 38
<b>CX70.408</b> Traverso piccolo mm. 72 <b>Peso</b> kg/ml. <b>1.480</b> <b>Jx</b> 28.98 cm <sup>4</sup> <b>Wx</b> 7.23 cm <sup>3</sup> <b>Jy</b> 9.52 cm <sup>4</sup> <b>Wy</b> 2.64 cm <sup>3</sup>		Tavola 31	<b>CX70.524</b> Fermavetro tondo mm. 26 <b>Peso</b> kg/ml. <b>0.314</b> <b>Jx</b> 00.00 cm <sup>4</sup> <b>Wx</b> 00.00 cm <sup>3</sup> <b>Jy</b> 00.00 cm <sup>4</sup> <b>Wy</b> 00.00 cm <sup>3</sup>		Tavola 38
<b>CX70.409</b> Soglia bassa <b>Peso</b> kg/ml. <b>0.785</b> <b>Jx</b> 14.28 cm <sup>4</sup> <b>Wx</b> 3,91 cm <sup>3</sup> <b>Jy</b> 0,60 cm <sup>4</sup> <b>Wy</b> 0,41 cm <sup>3</sup>		Tavola 13	<b>CX70.525</b> Fermavetro tondo mm. 30 <b>Peso</b> kg/ml. <b>0.350</b> <b>Jx</b> 00.00 cm <sup>4</sup> <b>Wx</b> 00.00 cm <sup>3</sup> <b>Jy</b> 00.00 cm <sup>4</sup> <b>Wy</b> 00.00 cm <sup>3</sup>		Tavola 38









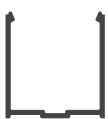
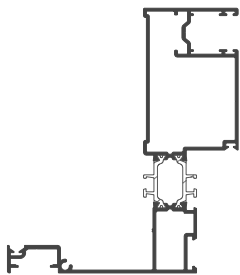

<b>CX70.526</b> Fermavetro diritto mm. 14 <b>Peso</b> kg/ml. <b>0.279</b> <b>Jx</b> 00.00 cm4 <b>Wx</b> 00.00 cm3 <b>Jy</b> 00.00 cm4 <b>Wy</b> 00.00 cm3		Tavola 39	<b>CX70.537</b> Fermavetro diritto mm. 40 <b>Peso</b> kg/ml. <b>0.403</b> <b>Jx</b> 00.00 cm4 <b>Wx</b> 0.00 cm3 <b>Jy</b> 00.00 cm4 <b>Wy</b> 0.00 cm3		Tavola 39
<b>CX70.527</b> Fermavetro diritto mm. 18 <b>Peso</b> kg/ml. <b>0.290</b> <b>Jx</b> 00.00 cm4 <b>Wx</b> 00.00 cm3 <b>Jy</b> 00.00 cm4 <b>Wy</b> 00.00 cm3		Tavola 39	<b>CX70.539</b> Fermavetro diritto mm. 10 <b>Peso</b> kg/ml. <b>0.245</b> <b>Jx</b> 00.00 cm4 <b>Wx</b> 0.00 cm3 <b>Jy</b> 00.00 cm4 <b>Wy</b> 0.00 cm3		Tavola 39
<b>CX70.528</b> Fermavetro diritto mm. 22 <b>Peso</b> kg/ml. <b>0.307</b> <b>Jx</b> 00.00 cm4 <b>Wx</b> 0.00 cm3 <b>Jy</b> 00.00 cm4 <b>Wy</b> 0.00 cm3		Tavola 39	<b>CX70.562</b> Fermavetro sicurezza mm. 14 <b>Peso</b> kg/ml. <b>0.324</b> <b>Jx</b> 00.00 cm4 <b>Wx</b> 00.00 cm3 <b>Jy</b> 00.00 cm4 <b>Wy</b> 00.00 cm3		Tavola 41
<b>CX70.529</b> Fermavetro diritto mm. 26 <b>Peso</b> kg/ml. <b>0.327</b> <b>Jx</b> 00.00 cm4 <b>Wx</b> 0.00 cm3 <b>Jy</b> 00.00 cm4 <b>Wy</b> 0.00 cm3		Tavola 39	<b>CX70.563</b> Fermavetro sicurezza mm. 18 <b>Peso</b> kg/ml. <b>0.330</b> <b>Jx</b> 00.00 cm4 <b>Wx</b> 00.00 cm3 <b>Jy</b> 00.00 cm4 <b>Wy</b> 00.00 cm3		Tavola 41
<b>CX70.530</b> Fermavetro diritto mm. 30 <b>Peso</b> kg/ml. <b>0.362</b> <b>Jx</b> 00.00 cm4 <b>Wx</b> 0.00 cm3 <b>Jy</b> 00.00 cm4 <b>Wy</b> 0.00 cm3		Tavola 39	<b>CX70.564</b> Fermavetro sicurezza mm. 22 <b>Peso</b> kg/ml. <b>0.348</b> <b>Jx</b> 00.00 cm4 <b>Wx</b> 0.00 cm3 <b>Jy</b> 00.00 cm4 <b>Wy</b> 0.00 cm3		Tavola 41
<b>CX70.531</b> Fermavetro tondo mm. 35 <b>Peso</b> kg/ml. <b>0.370</b> <b>Jx</b> 00.00 cm4 <b>Wx</b> 0.00 cm3 <b>Jy</b> 00.00 cm4 <b>Wy</b> 0.00 cm3		Tavola 38	<b>CX70.565</b> Fermavetro sicurezza mm. 26 <b>Peso</b> kg/ml. <b>0.372</b> <b>Jx</b> 00.00 cm4 <b>Wx</b> 0.00 cm3 <b>Jy</b> 00.00 cm4 <b>Wy</b> 0.00 cm3		Tavola 41
<b>CX70.532</b> Fermavetro diritto mm. 35 <b>Peso</b> kg/ml. <b>0.383</b> <b>Jx</b> 00.00 cm4 <b>Wx</b> 0.00 cm3 <b>Jy</b> 00.00 cm4 <b>Wy</b> 0.00 cm3		Tavola 39	<b>CX70.566</b> Fermavetro sicurezza mm. 30 <b>Peso</b> kg/ml. <b>0.396</b> <b>Jx</b> 00.00 cm4 <b>Wx</b> 0.00 cm3 <b>Jy</b> 00.00 cm4 <b>Wy</b> 0.00 cm3		Tavola 41
<b>CX70.533</b> Fermavetro diritto mm. 5 <b>Peso</b> kg/ml. <b>0.252</b> <b>Jx</b> 00.00 cm4 <b>Wx</b> 0.00 cm3 <b>Jy</b> 00.00 cm4 <b>Wy</b> 0.00 cm3		Tavola 39	<b>CX70.567</b> Fermavetro sicurezza mm. 35 <b>Peso</b> kg/ml. <b>0.434</b> <b>Jx</b> 00.00 cm4 <b>Wx</b> 0.00 cm3 <b>Jy</b> 00.00 cm4 <b>Wy</b> 0.00 cm3		Tavola 41

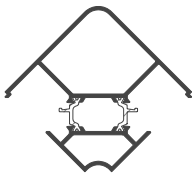

<b>CX70.568</b> Fermavetro sicurezza mm. 10 <b>Peso</b> kg/ml. <b>0.297</b> <b>Jx</b> 00.00 cm <sup>4</sup> <b>Wx</b> 0.00 cm <sup>3</sup> <b>Jy</b> 00.00 cm <sup>4</sup> <b>Wy</b> 0.00 cm <sup>3</sup>		Tavola 41	<b>XX70.601</b> Gocciolatoio <b>Peso</b> kg/ml. <b>0.269</b> <b>Jx</b> 00.00 cm <sup>4</sup> <b>Wx</b> 0.00 cm <sup>3</sup> <b>Jy</b> 00.00 cm <sup>4</sup> <b>Wy</b> 0.00 cm <sup>3</sup>		Tavola 21
<b>CX70.571</b> Fermavetro clips tondo mm. 14 <b>Peso</b> kg/ml. <b>0.216</b> <b>Jx</b> 00.00 cm <sup>4</sup> <b>Wx</b> 00.00 cm <sup>3</sup> <b>Jy</b> 00.00 cm <sup>4</sup> <b>Wy</b> 00.00 cm <sup>3</sup>		Tavola 40	<b>XX70.602</b> Porta spazzolino <b>Peso</b> kg/ml. <b>0.372</b> <b>Jx</b> 00.00 cm <sup>4</sup> <b>Wx</b> 0.00 cm <sup>3</sup> <b>Jy</b> 00.00 cm <sup>4</sup> <b>Wy</b> 0.00 cm <sup>3</sup>		Tavola 21
<b>CX70.572</b> Fermavetro clips tondo mm. 18 <b>Peso</b> kg/ml. <b>0.262</b> <b>Jx</b> 00.00 cm <sup>4</sup> <b>Wx</b> 00.00 cm <sup>3</sup> <b>Jy</b> 00.00 cm <sup>4</sup> <b>Wy</b> 00.00 cm <sup>3</sup>		Tavola 40	<b>XX70.603</b> Soglia piatta da mm. 5 <b>Peso</b> kg/ml. <b>0.275</b> <b>Jx</b> 00.00 cm <sup>4</sup> <b>Wx</b> 0.00 cm <sup>3</sup> <b>Jy</b> 00.00 cm <sup>4</sup> <b>Wy</b> 0.00 cm <sup>3</sup>		Tavola 21
<b>CX70.573</b> Fermavetro clips tondo mm. 22 <b>Peso</b> kg/ml. <b>0.283</b> <b>Jx</b> 00.00 cm <sup>4</sup> <b>Wx</b> 00.00 cm <sup>3</sup> <b>Jy</b> 00.00 cm <sup>4</sup> <b>Wy</b> 00.00 cm <sup>3</sup>		Tavola 40	<b>CX70.604</b> Inversione di battuta <b>Peso</b> kg/ml. <b>1.195</b> <b>Jx</b> 16.97 cm <sup>4</sup> <b>Wx</b> 5.83 cm <sup>3</sup> <b>Jy</b> 4.77 cm <sup>4</sup> <b>Wy</b> 1.50 cm <sup>3</sup>		Tavola 25
<b>CX70.574</b> Fermavetro clips tondo mm. 26 <b>Peso</b> kg/ml. <b>0.313</b> <b>Jx</b> 00.00 cm <sup>4</sup> <b>Wx</b> 00.00 cm <sup>3</sup> <b>Jy</b> 00.00 cm <sup>4</sup> <b>Wy</b> 00.00 cm <sup>3</sup>		Tavola 40	<b>CX70.605</b> Astina <b>Peso</b> kg/ml. <b>0.146</b> <b>Jx</b> 0,00 cm <sup>4</sup> <b>Wx</b> 0,00 cm <sup>3</sup> <b>Jy</b> 0,00 cm <sup>4</sup> <b>Wy</b> 0,00 cm <sup>3</sup>		Tavola 18
<b>CX70.575</b> Fermavetro clips tondo mm. 30 <b>Peso</b> kg/ml. <b>0.340</b> <b>Jx</b> 00.00 cm <sup>4</sup> <b>Wx</b> 00.00 cm <sup>3</sup> <b>Jy</b> 00.00 cm <sup>4</sup> <b>Wy</b> 00.00 cm <sup>3</sup>		Tavola 40	<b>XX70.606</b> Scivolo esterno soglia bassa <b>Peso</b> kg/ml. <b>0.322</b> <b>Jx</b> 0,00 cm <sup>4</sup> <b>Wx</b> 0,00 cm <sup>3</sup> <b>Jy</b> 0,00 cm <sup>4</sup> <b>Wy</b> 0,00 cm <sup>3</sup>		Tavola 13
<b>CX70.581</b> Fermavetro clips tondo mm. 35 <b>Peso</b> kg/ml. <b>0.361</b> <b>Jx</b> 00.00 cm <sup>4</sup> <b>Wx</b> 00.00 cm <sup>3</sup> <b>Jy</b> 00.00 cm <sup>4</sup> <b>Wy</b> 00.00 cm <sup>3</sup>		Tavola 40	<b>XX70.607</b> Scivolo interno soglia bassa <b>Peso</b> kg/ml. <b>0.224</b> <b>Jx</b> 0,00 cm <sup>4</sup> <b>Wx</b> 0,00 cm <sup>3</sup> <b>Jy</b> 0,00 cm <sup>4</sup> <b>Wy</b> 0,00 cm <sup>3</sup>		Tavola 13
			<b>RX70.609</b> Prof. di chiusura rinforzo montanti <b>Peso</b> kg/ml. <b>0.393</b> <b>Jx</b> 0.10 cm <sup>4</sup> <b>Wx</b> 0.11 cm <sup>3</sup> <b>Jy</b> 3.99 cm <sup>4</sup> <b>Wy</b> 1.53 cm <sup>3</sup>		Tavola 23

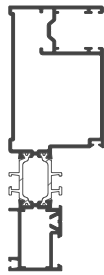
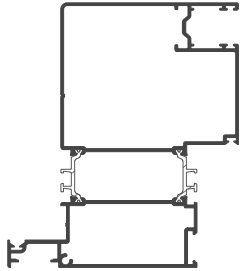
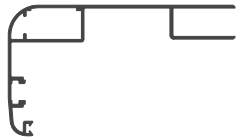

<b>RX70.610</b> Profilo per rinforzo montanti <b>Peso</b> kg/ml. <b>0.994</b> <b>Jx</b> 12.49 cm <sup>4</sup> <b>Wx</b> 3.56 cm <sup>3</sup> <b>Jy</b> 17.78 cm <sup>4</sup> <b>Wy</b> 6.84 cm <sup>3</sup>		Tavola 23	<b>CX70.702</b> Spalla laterale aperta <b>Peso</b> kg/ml. <b>2.617</b> <b>Jx</b> 222.35 cm <sup>4</sup> <b>Wx</b> 28.56 cm <sup>3</sup> <b>Jy</b> 91.91 cm <sup>4</sup> <b>Wy</b> 11.55 cm <sup>3</sup>		Tavola 26
<b>XX70.611</b> Profilo per squadretta <b>Peso</b> kg/ml. <b>3.426</b> <b>Jx</b> 00.00 cm <sup>4</sup> <b>Wx</b> 0.00 cm <sup>3</sup> <b>Jy</b> 00.00 cm <sup>4</sup> <b>Wy</b> 0.00 cm <sup>3</sup>		Tavola 24			
<b>XX70.612</b> Profilo bancalino <b>Peso</b> kg/ml. <b>0.245</b> <b>Jx</b> 00.00 cm <sup>4</sup> <b>Wx</b> 0.00 cm <sup>3</sup> <b>Jy</b> 00.00 cm <sup>4</sup> <b>Wy</b> 0.00 cm <sup>3</sup>		Tavola 13	<b>XX70.703</b> Traverso superiore monoblocco <b>Peso</b> kg/ml. <b>0.791</b> <b>Jx</b> 00.00 cm <sup>4</sup> <b>Wx</b> 0.00 cm <sup>3</sup> <b>Jy</b> 00.00 cm <sup>4</sup> <b>Wy</b> 0.00 cm <sup>3</sup>		Tavola 27
<b>XX70.613</b> Profilo angolo universale <b>Peso</b> kg/ml. <b>1.885</b> <b>Jx</b> 00.00 cm <sup>4</sup> <b>Wx</b> 0.00 cm <sup>3</sup> <b>Jy</b> 00.00 cm <sup>4</sup> <b>Wy</b> 0.00 cm <sup>3</sup>		Tavola 24	<b>XX70.704</b> Coprivite <b>Peso</b> kg/ml. <b>0.135</b> <b>Jx</b> 00.00 cm <sup>4</sup> <b>Wx</b> 0.00 cm <sup>3</sup> <b>Jy</b> 00.00 cm <sup>4</sup> <b>Wy</b> 0.00 cm <sup>3</sup>		Tavola 27
<b>XX70.627</b> Battuta riportata per zoccolo <b>Peso</b> kg/ml. <b>0.671</b> <b>Jx</b> 00.00 cm <sup>4</sup> <b>Wx</b> 0.00 cm <sup>3</sup> <b>Jy</b> 00.00 cm <sup>4</sup> <b>Wy</b> 0.00 cm <sup>3</sup>		Tavola 22	<b>XX70.705</b> Profilo battuta cassonetto <b>Peso</b> kg/ml. <b>0.155</b> <b>Jx</b> 00.00 cm <sup>4</sup> <b>Wx</b> 0.00 cm <sup>3</sup> <b>Jy</b> 00.00 cm <sup>4</sup> <b>Wy</b> 0.00 cm <sup>3</sup>		Tavola 27
<b>XX60.635</b> Battuta riportata per telaio <b>Peso</b> kg/ml. <b>0.306</b> <b>Jx</b> 00.00 cm <sup>4</sup> <b>Wx</b> 0.00 cm <sup>3</sup> <b>Jy</b> 00.00 cm <sup>4</sup> <b>Wy</b> 0.00 cm <sup>3</sup>		Tavola 15 - b	<b>CX70.706</b> Mezza spalla monoblocco <b>Peso</b> kg/ml. <b>2.191</b> <b>Jx</b> 165.80 cm <sup>4</sup> <b>Wx</b> 22.14 cm <sup>3</sup> <b>Jy</b> 18.80 cm <sup>4</sup> <b>Wy</b> 6.56 cm <sup>3</sup>		Tavola 27
<b>CX70.701</b> Spalla laterale chiusa <b>Peso</b> kg/ml. <b>3.152</b> <b>Jx</b> 260.63 cm <sup>4</sup> <b>Wx</b> 34.86 cm <sup>3</sup> <b>Jy</b> 136.59 cm <sup>4</sup> <b>Wy</b> 20.42 cm <sup>3</sup>		Tavola 26	<b>XX70.801</b> Imbotte da mm. 120 <b>Peso</b> kg/ml. <b>1.317</b> <b>Jx</b> 76.93 cm <sup>4</sup> <b>Wx</b> 9.91 cm <sup>3</sup> <b>Jy</b> 20.54 cm <sup>4</sup> <b>Wy</b> 4.10 cm <sup>3</sup>		Tavola 30



<b>XX70.802</b>			Tavola 30
Prolunga da 90 mm. per imbotte			
<b>Peso</b>	kg/ml. <b>0.882</b>		
<b>Jx</b>	00.00 cm <sup>4</sup> <b>Wx</b> 0.00 cm <sup>3</sup>		
<b>Jy</b>	00.00 cm <sup>4</sup> <b>Wy</b> 0.00 cm <sup>3</sup>		

 Serie **SLIM**

<b>XX70.803</b>			Tavola 30
Prolunga da 50 mm. per imbotte			
<b>Peso</b>	kg/ml. <b>0.574</b>		
<b>Jx</b>	00.00 cm <sup>4</sup> <b>Wx</b> 0.00 cm <sup>3</sup>		
<b>Jy</b>	00.00 cm <sup>4</sup> <b>Wy</b> 0.00 cm <sup>3</sup>		

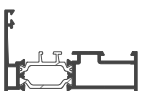
<b>CX70S.101</b>			Tavola 42
Telaio SLIM ad " L "			
<b>Peso</b>	kg/ml. <b>1.067</b>		
<b>Jx</b>	00.00 cm <sup>4</sup> <b>Wx</b> 0.00 cm <sup>3</sup>		
<b>Jy</b>	00.00 cm <sup>4</sup> <b>Wy</b> 0.00 cm <sup>3</sup>		

<b>XX70.808</b>			Tavola 30
Profilo jolly per imbotte			
<b>Peso</b>	kg/ml. <b>0.750</b>		
<b>Jx</b>	00.00 cm <sup>4</sup> <b>Wx</b> 0.00 cm <sup>3</sup>		
<b>Jy</b>	00.00 cm <sup>4</sup> <b>Wy</b> 0.00 cm <sup>3</sup>		

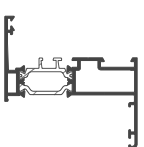
<b>CX70S.102</b>			Tavola 42
Telaio SLIM ad " Z "			
<b>Peso</b>	kg/ml. <b>1.199</b>		
<b>Jx</b>	00.00 cm <sup>4</sup> <b>Wx</b> 0.00 cm <sup>3</sup>		
<b>Jy</b>	00.00 cm <sup>4</sup> <b>Wy</b> 0.00 cm <sup>3</sup>		

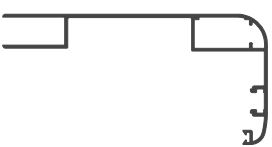
<b>XX70.809</b>			Tavola 30
Imbotte da mm. 140			
<b>Peso</b>	kg/ml. <b>1.580</b>		
<b>Jx</b>	123.04 cm <sup>4</sup> <b>Wx</b> 13.89 cm <sup>3</sup>		
<b>Jy</b>	22.31 cm <sup>4</sup> <b>Wy</b> 4.30 cm <sup>3</sup>		

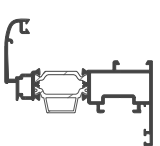
<b>CX70S.201</b>			Tavola 43
Anta piccola SLIM			
<b>Peso</b>	kg/ml. <b>1.348</b>		
<b>Jx</b>	00.00 cm <sup>4</sup> <b>Wx</b> 0.00 cm <sup>3</sup>		
<b>Jy</b>	00.00 cm <sup>4</sup> <b>Wy</b> 0.00 cm <sup>3</sup>		

<b>CX45.3362</b>			Tavola 28
Profilo centrale cassonetto			
<b>Peso</b>	kg/ml. <b>1.150</b>		
<b>Jx</b>	00.00 cm <sup>4</sup> <b>Wx</b> 0.00 cm <sup>3</sup>		
<b>Jy</b>	00.00 cm <sup>4</sup> <b>Wy</b> 0.00 cm <sup>3</sup>		

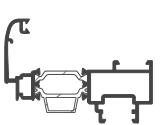
<b>CX70S.201R</b>			Tavola 43
Anta piccola SLIM s/battuta			
<b>Peso</b>	kg/ml. <b>1.302</b>		
<b>Jx</b>	00.00 cm <sup>4</sup> <b>Wx</b> 0.00 cm <sup>3</sup>		
<b>Jy</b>	00.00 cm <sup>4</sup> <b>Wy</b> 0.00 cm <sup>3</sup>		

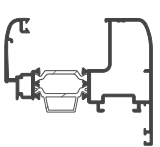
<b>CX70S.203</b>			Tavola 43
Anta piccola v.inf.SLIM			
<b>Peso</b>	kg/ml. <b>1.499</b>		
<b>Jx</b>	00.00 cm <sup>4</sup> <b>Wx</b> 0.00 cm <sup>3</sup>		
<b>Jy</b>	00.00 cm <sup>4</sup> <b>Wy</b> 0.00 cm <sup>3</sup>		

<b>CX45.3363</b>			Tavola 28
Profilo sup./ inf. cassonetto			
<b>Peso</b>	kg/ml. <b>1.379</b>		
<b>Jx</b>	00.00 cm <sup>4</sup> <b>Wx</b> 0.00 cm <sup>3</sup>		
<b>Jy</b>	00.00 cm <sup>4</sup> <b>Wy</b> 0.00 cm <sup>3</sup>		

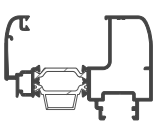
<b>CX70S.203R</b>			Tavola 43
Anta piccola v.inf.SLIM s/battuta			
<b>Peso</b>	kg/ml. <b>1.454</b>		
<b>Jx</b>	00.00 cm <sup>4</sup> <b>Wx</b> 0.00 cm <sup>3</sup>		
<b>Jy</b>	00.00 cm <sup>4</sup> <b>Wy</b> 0.00 cm <sup>3</sup>		

<b>CX60S.304</b>			Tavola 42
Incontro centrale			
<b>Peso</b>	kg/ml. <b>0.427</b>		
<b>Jx</b>	00.00 cm <sup>4</sup> <b>Wx</b> 0.00 cm <sup>3</sup>		
<b>Jy</b>	00.00 cm <sup>4</sup> <b>Wy</b> 0.00 cm <sup>3</sup>		

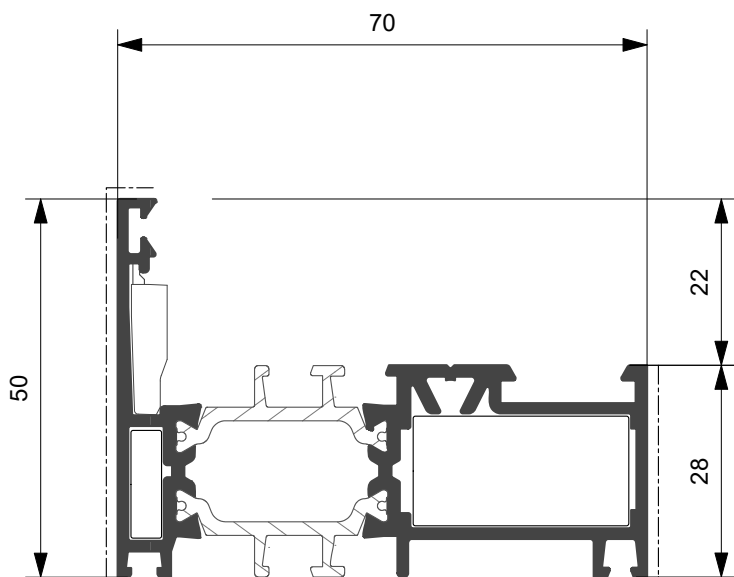

**CX70.101**

Kg/ml 1.287  
--- mm. 78,0

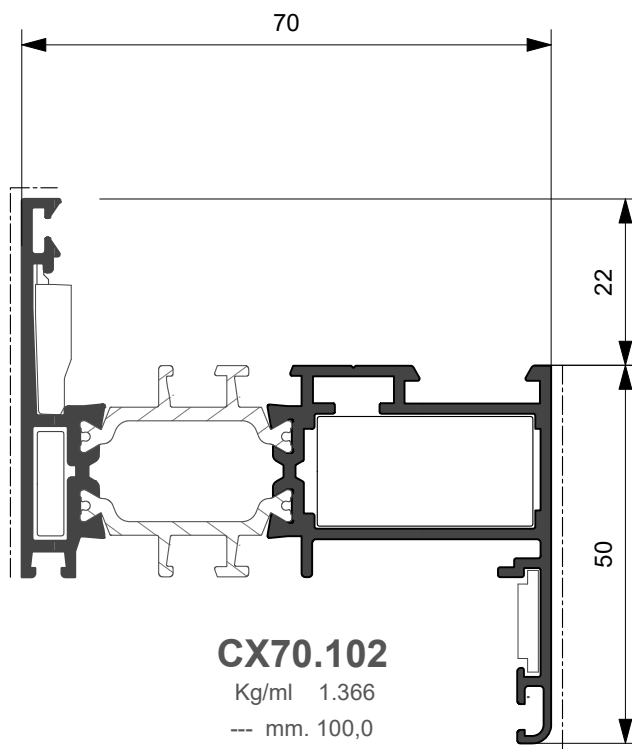

**CX70.102**

Kg/ml 1.366  
--- mm. 100,0

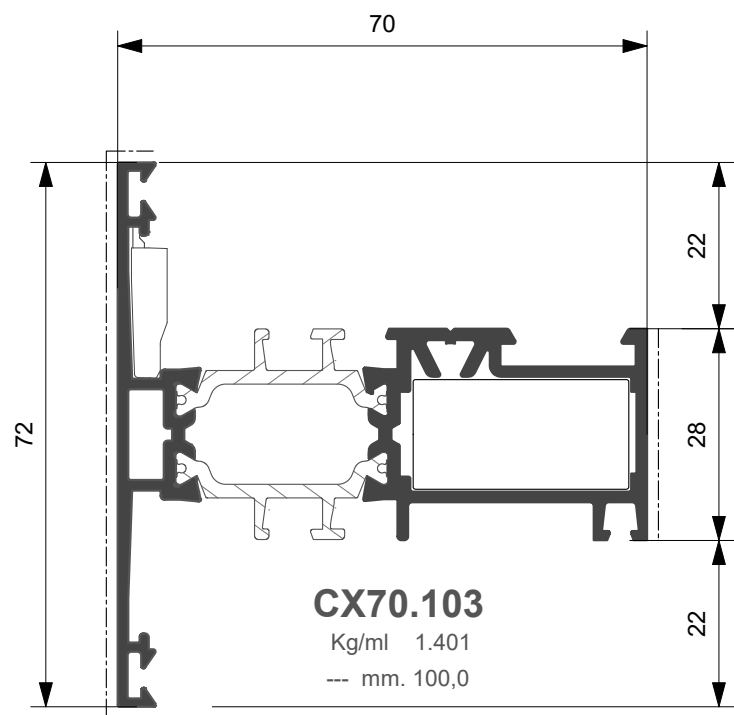

**CX70.103**

Kg/ml 1.401  
--- mm. 100,0

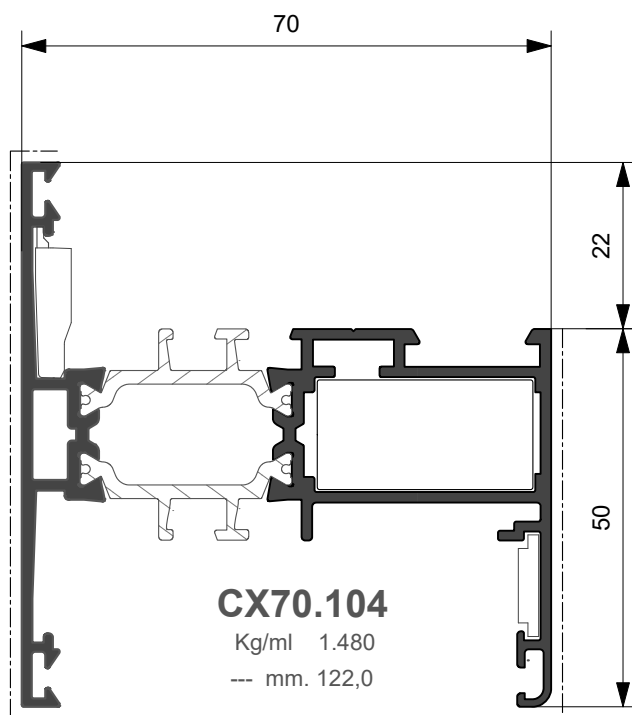

**CX70.104**

Kg/ml 1.480  
--- mm. 122,0

Profilato	Squadretta esterna		Squadretta interna			Squadretta allineamento	
	Cianfrinare	Spinare	Bottone	Cianfrinare	Spinare	Esterna	Interna
CX70.101	ARX.03.SQ	ARX.03.SQ + ARX.08.SQ	ACX.01.SQ	ACX.02.SQ	ACX.02.SQ + ARX.07.SQ	ARX.15.SQ	
CX70.102	ARX.03.SQ	ARX.03.SQ + ARX.08.SQ	ACX.01.SQ	ACX.02.SQ	ACX.02.SQ + ARX.07.SQ	ARX.15.SQ	ARX.10.SQ
CX70.103			ACX.01.SQ	ACX.02.SQ	ACX.02.SQ + ARX.07.SQ	ARX.15.SQ	
CX70.104			ACX.01.SQ	ACX.02.SQ	ACX.02.SQ + ARX.07.SQ	ARX.15.SQ	ARX.10.SQ

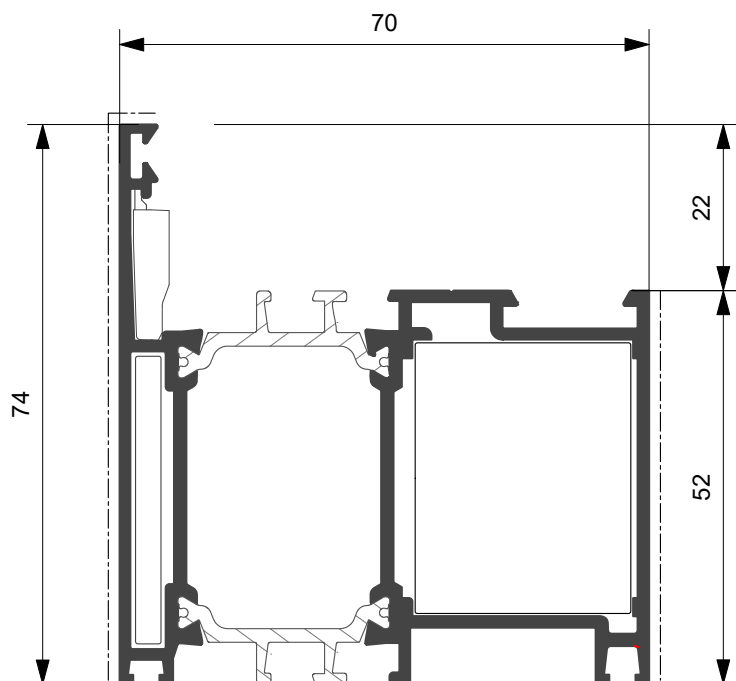

**CX70.105**

Kg/ml 1.681  
--- mm. 126,0

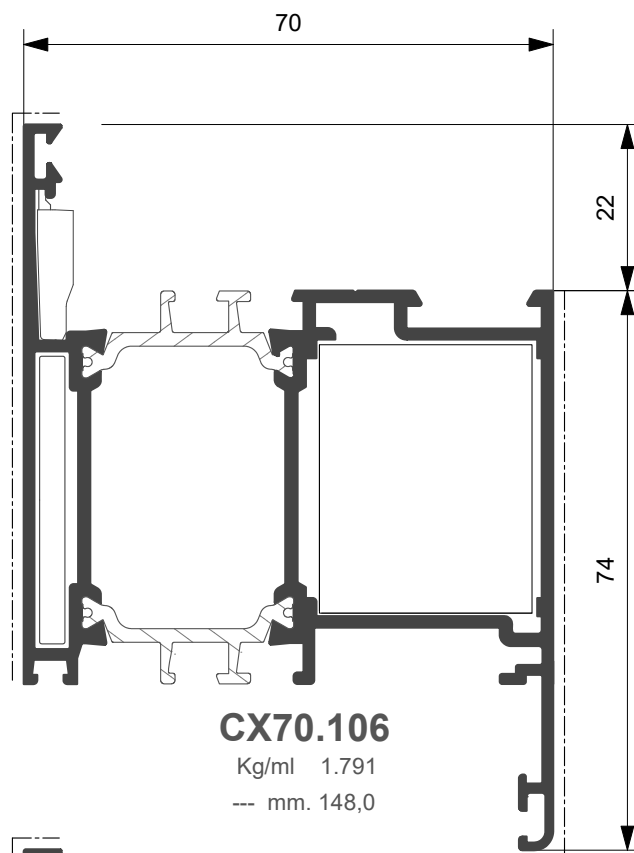

**CX70.106**

Kg/ml 1.791  
--- mm. 148,0

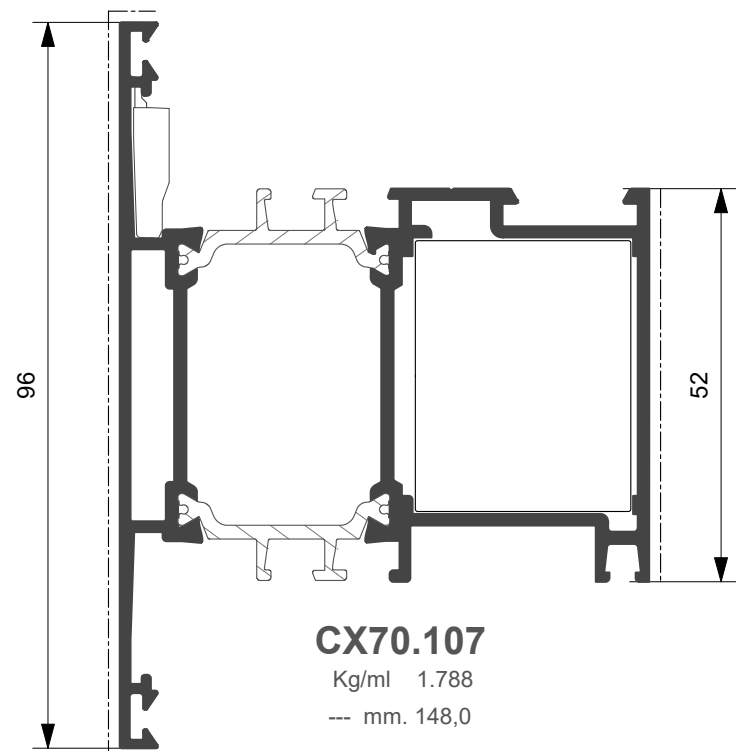

**CX70.107**

Kg/ml 1.788  
--- mm. 148,0

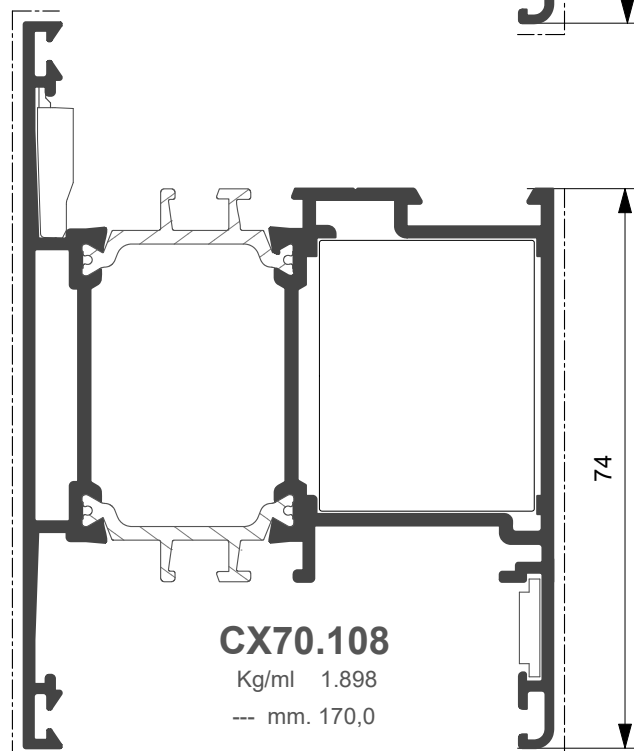

**CX70.108**

Kg/ml 1.898  
--- mm. 170,0

Profilato	Squadretta esterna		Squadretta interna			Squadretta allineamento	
	Cianfrinare	Spinare	Bottone	Cianfrinare	Spinare o Avvitare	Esterna	Interna
CX70.105	ARX.06.SQ	ARX.06.SQ + ARX.08.SQ	ACX.04.SQ	ACX.14.SQ	ACX.14.SQ	ARX.15.SQ	
CX70.106	ARX.06.SQ	ARX.06.SQ + ARX.08.SQ	ACX.04.SQ	ACX.14.SQ	ACX.14.SQ	ARX.15.SQ	ARX.10.SQ
CX70.107			ACX.04.SQ	ACX.14.SQ	ACX.14.SQ	ARX.15.SQ	
CX70.108			ACX.04.SQ	ACX.14.SQ	ACX.14.SQ	ARX.15.SQ	ARX.10.SQ



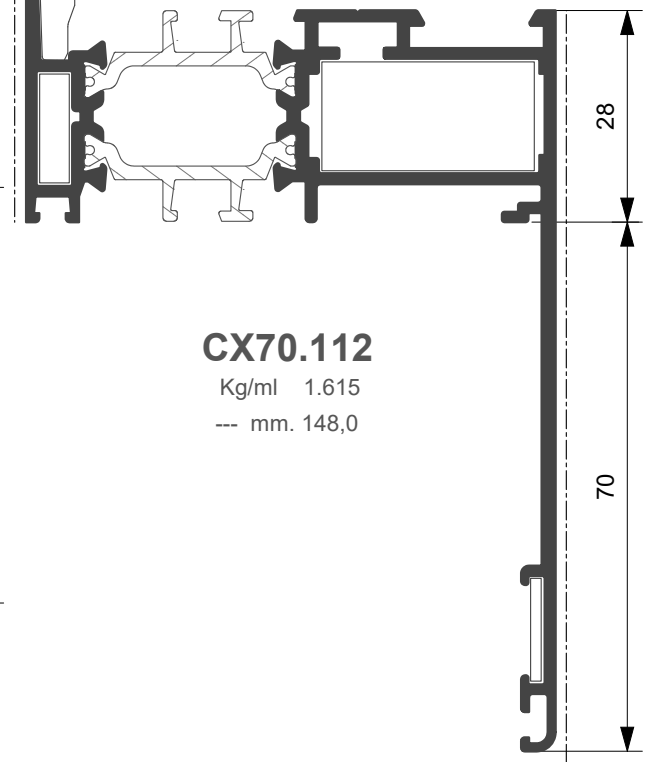
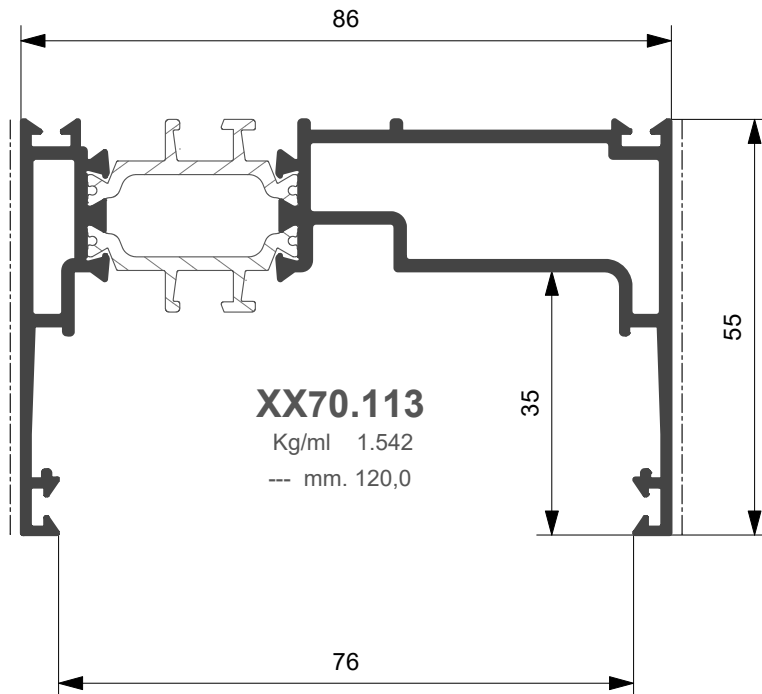
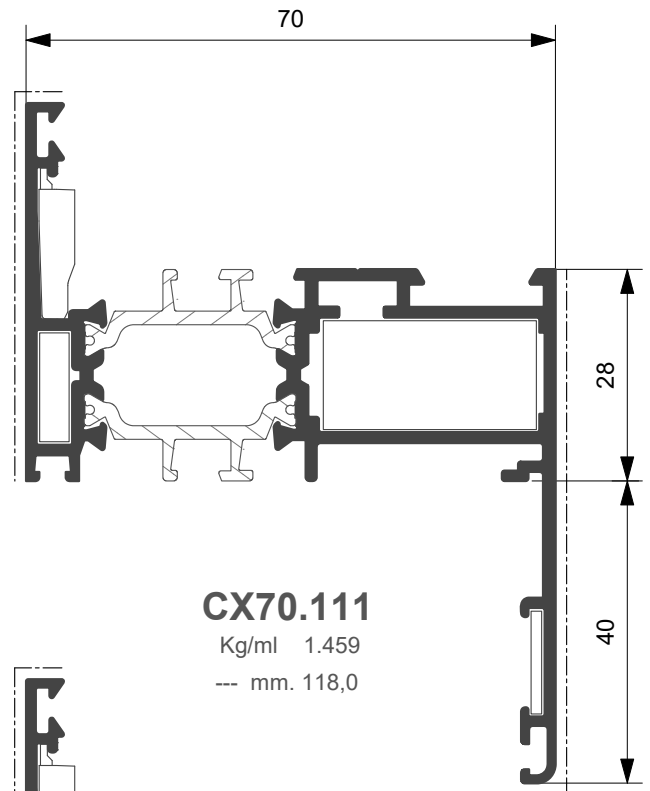
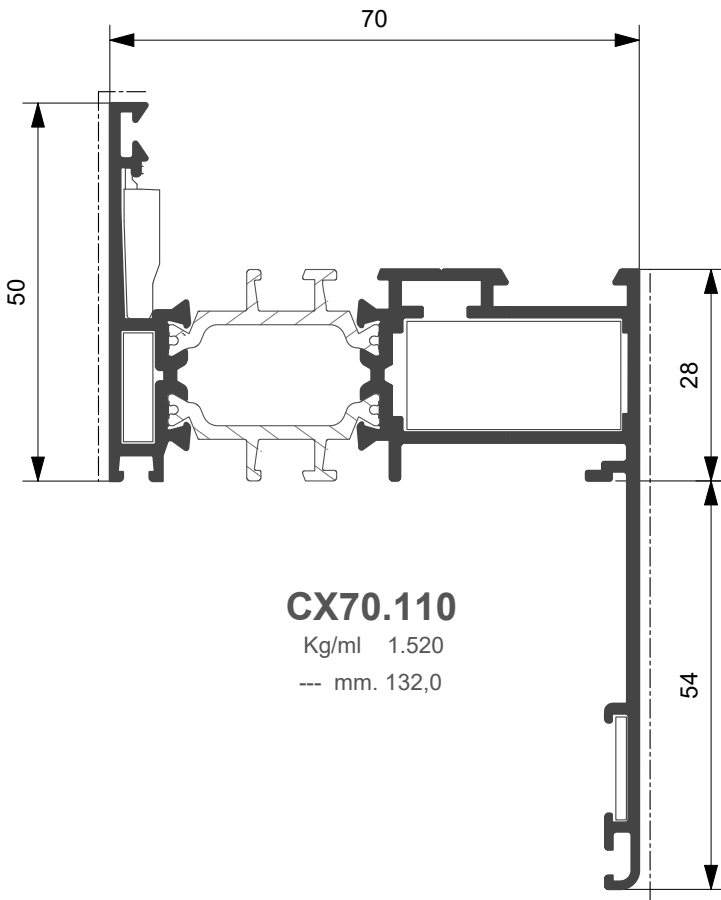

Profilato	Squadretta esterna		Squadretta interna			Squadretta allineamento	
	Cianfrinare	Spinare	Bottone	Cianfrinare	Spinare	Esterna	Interna
CX70.110	ARX.03.SQ	ARX.03.SQ + ARX.08.SQ	ACX.01.SQ	ACX.02.SQ	ACX.02.SQ + ARX.07.SQ	ARX.15.SQ	ARX.10.SQ
CX70.111	ARX.03.SQ	ARX.03.SQ + ARX.08.SQ	ACX.01.SQ	ACX.02.SQ	ACX.02.SQ + ARX.07.SQ	ARX.15.SQ	ARX.10.SQ
CX70.112	ARX.03.SQ	ARX.03.SQ + ARX.08.SQ	ACX.01.SQ	ACX.02.SQ	ACX.02.SQ + ARX.07.SQ	ARX.15.SQ	ARX.10.SQ

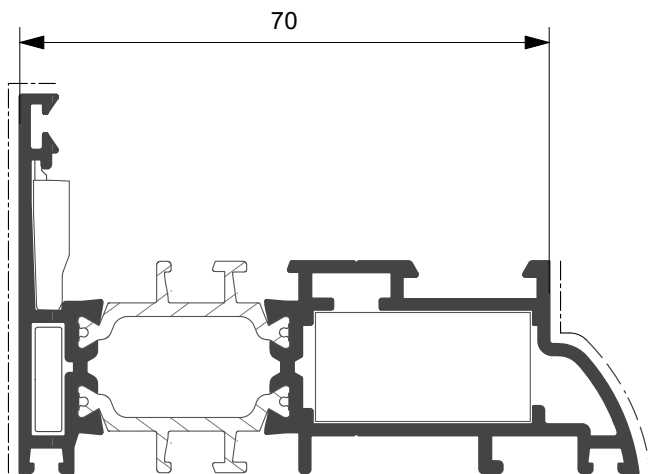

**CX70.155**

Kg/ml 1.307  
--- mm. 88,0

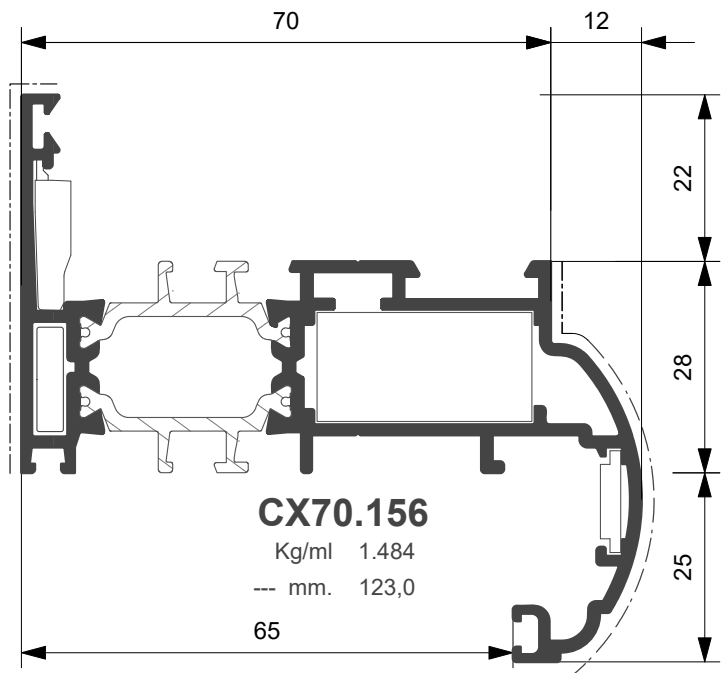

**CX70.156**

Kg/ml 1.484  
--- mm. 123,0

65

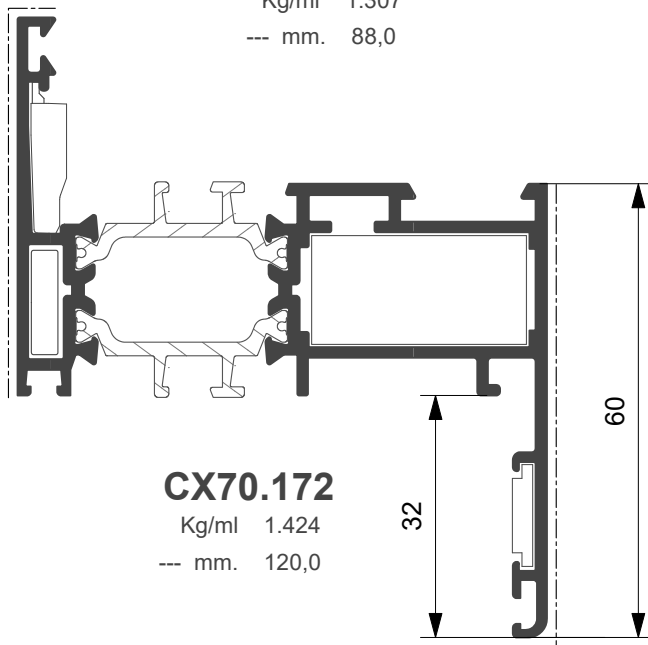

**CX70.172**

Kg/ml 1.424  
--- mm. 120,0

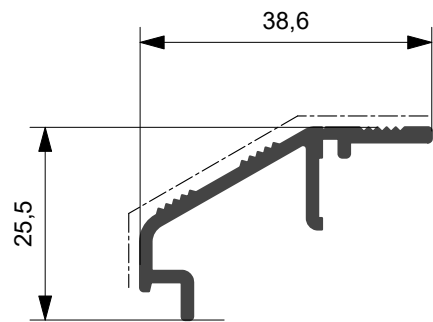

**XX70.606**

Kg/ml 0.322  
--- mm. 50,0

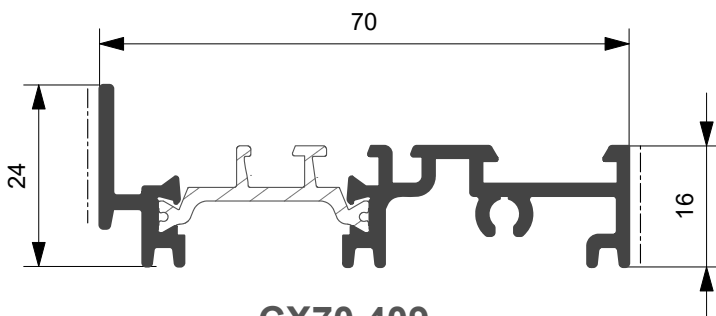

**CX70.409**

Kg/ml 0.785  
--- mm. 34,0

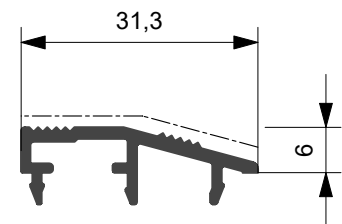

**XX70.607**

Kg/ml 0.224  
--- mm. 32,0

Profilato	Squadretta esterna		Squadretta interna			Squadretta allineamento	
	Cianfrinare	Spinare	Bottono	Cianfrinare	Spinare	Esterna	Interna
CX70.155	ARX.03.SQ	ARX.03.SQ + ARX.08.SQ	ACX.01.SQ	ACX.02.SQ	ACX.02.SQ + ARX.07.SQ	ARX.15.SQ	
CX70.156	ARX.03.SQ	ARX.03.SQ + ARX.08.SQ	ACX.01.SQ	ACX.02.SQ	ACX.02.SQ + ARX.07.SQ	ARX.15.SQ	ARX.10.SQ
CX70.172	ARX.03.SQ	ARX.03.SQ + ARX.08.SQ	ACX.01.SQ	ACX.02.SQ	ACX.02.SQ + ARX.07.SQ	ARX.15.SQ	ARX.10.SQ

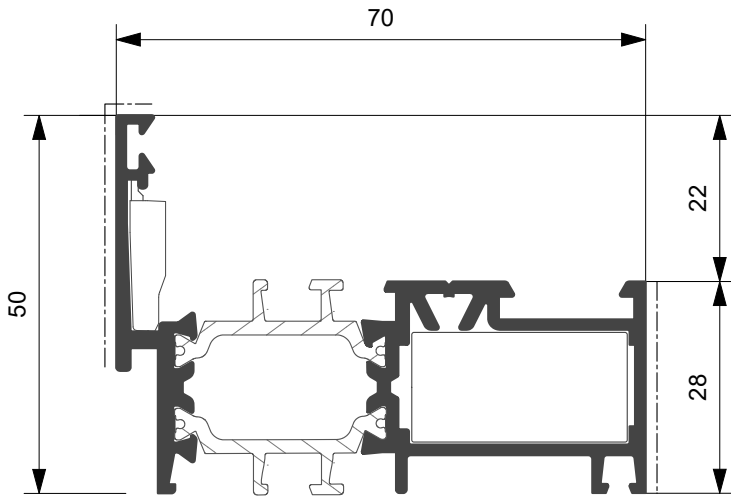

**CX70.124**

Kg/ml 1.212  
--- mm. 78,0

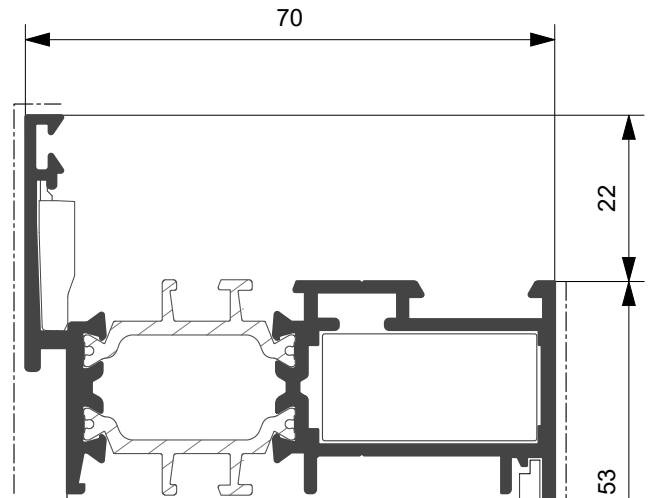

**CX70.125**

Kg/ml 1.355  
--- mm. 100,0

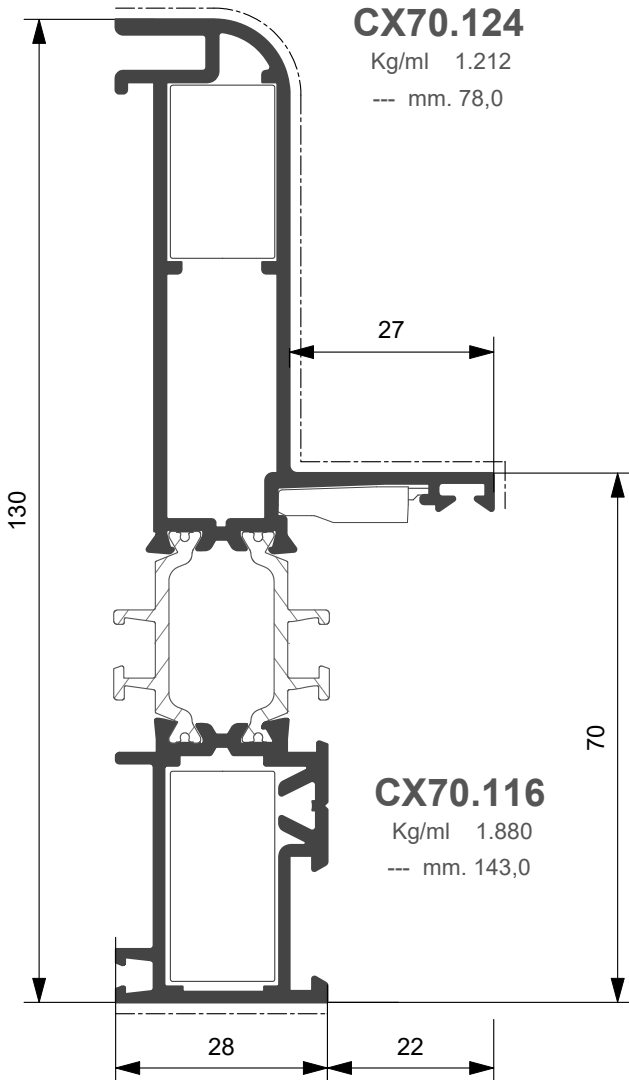

**CX70.116**

Kg/ml 1.880  
--- mm. 143,0

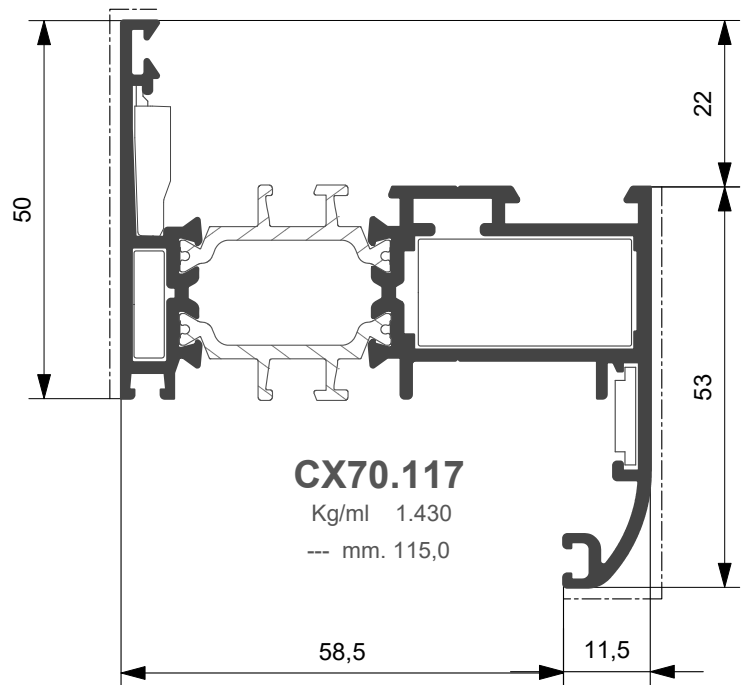

**CX70.117**

Kg/ml 1.430  
--- mm. 115,0

Profilato	Squadretta esterna		Squadretta interna			Squadretta allineamento	
	Cianfrinare	Spinare	Bottone	Cianfrinare	Spinare	Esterna	Interna
CX70.116	ARX.13.SQ a bottone		ACX.01.SQ			ARX.15.SQ	
CX70.117	ARX.03.SQ	ARX.03.SQ + ARX.08.SQ	ACX.01.SQ	ACX.02.SQ	ACX.02.SQ + ARX.07.SQ	ARX.15.SQ	ARX.10.SQ
CX70.124			ACX.01.SQ	ACX.02.SQ	ACX.02.SQ + ARX.07.SQ	ARX.15.SQ	
CX70.125			ACX.01.SQ	ACX.02.SQ	ACX.02.SQ + ARX.07.SQ	ARX.15.SQ	ARX.10.SQ

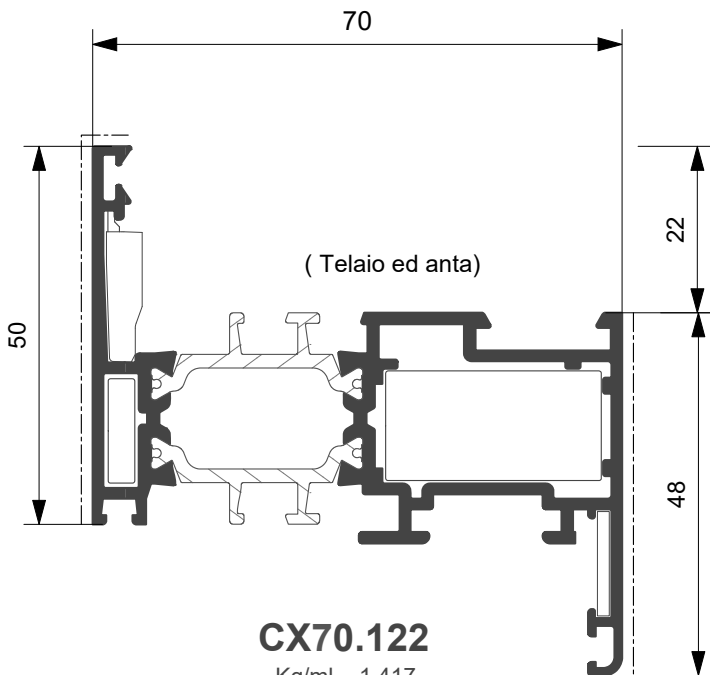

**CX70.122**  
Kg/ml 1.417  
--- mm. 98

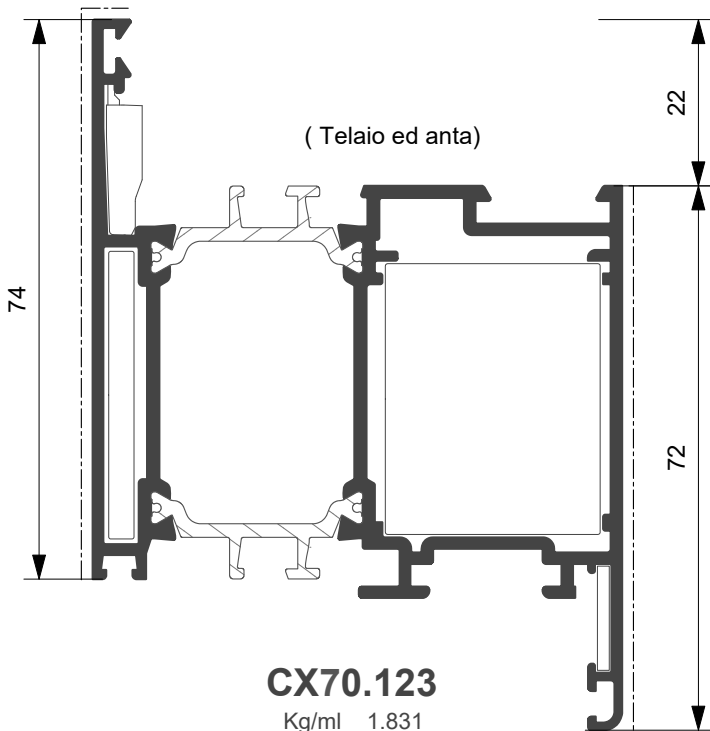

**CX70.123**  
Kg/ml 1.831  
--- mm. 146

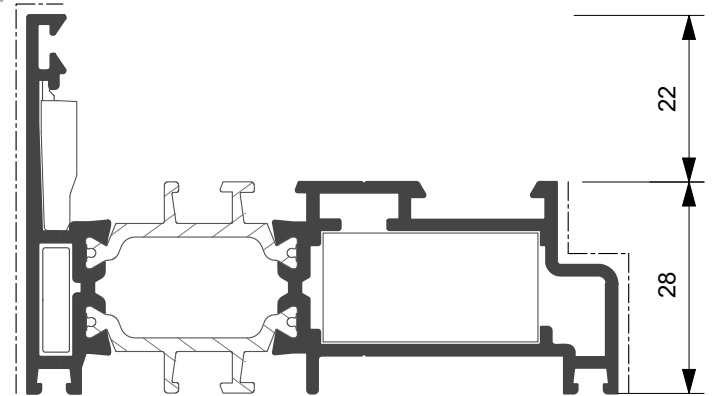

**CX70.119**  
Kg/ml 1.273  
--- mm. 86,0

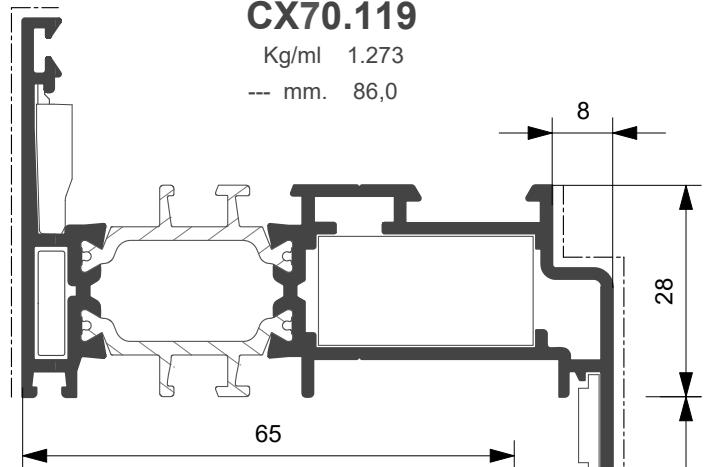

**CX70.120**  
Kg/ml 1.447  
--- mm. 111,0

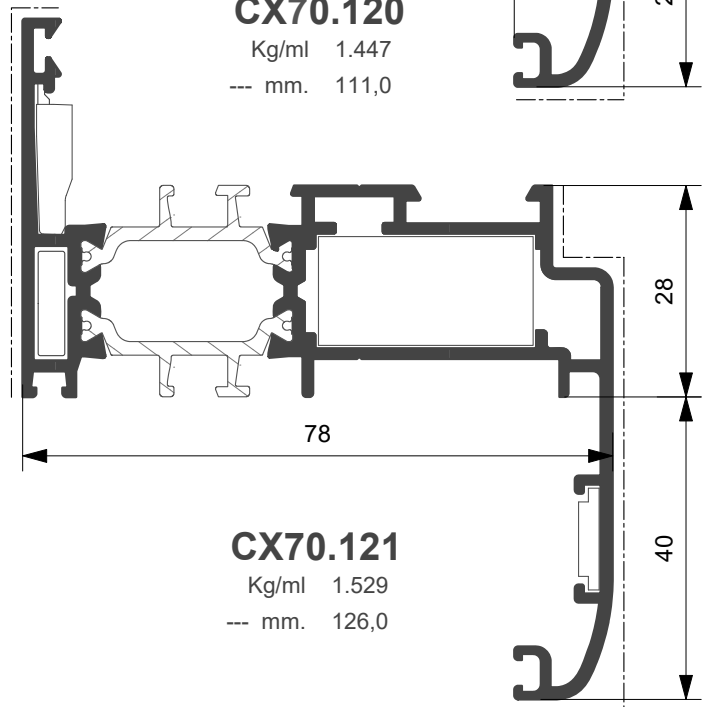

**CX70.121**  
Kg/ml 1.529  
--- mm. 126,0

Profilato	Squadretta esterna		Squadretta interna			Squadretta allineamento	
	Cianfrinare	Spinare	Bottone	Cianfrinare	Spinare	Esterna	Interna
CX70.119	ARX.03.SQ	ARX.03.SQ + ARX.08.SQ	ACX.01.SQ	ACX.02.SQ	ACX.02.SQ + ARX.07.SQ	ARX.15.SQ	
CX70.120	ARX.03.SQ	ARX.03.SQ + ARX.08.SQ	ACX.01.SQ	ACX.02.SQ	ACX.02.SQ + ARX.07.SQ	ARX.15.SQ	ARX.10.SQ
CX70.121	ARX.03.SQ	ARX.03.SQ + ARX.08.SQ	ACX.01.SQ	ACX.02.SQ	ACX.02.SQ + ARX.07.SQ	ARX.15.SQ	ARX.10.SQ
CX70.122	ARX.03.SQ	ARX.03.SQ + ARX.08.SQ	ACX.01.SQ	ACX.02.SQ	ACX.02.SQ + ARX.07.SQ	ARX.15.SQ	ARX.10.SQ
CX70.123	ARX.06.SQ	ARX.06.SQ + ARX.08.SQ	ACX.04.SQ	ACX.14.SQ	ACX.14.SQ	ARX.15.SQ	ARX.10.SQ

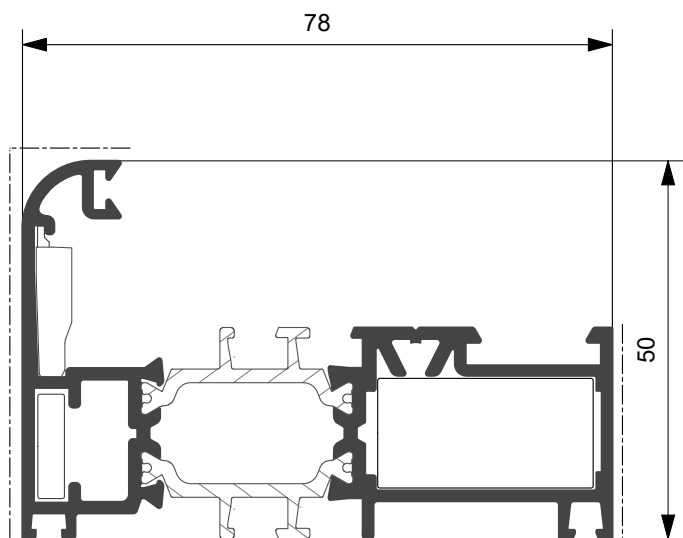

**CX70.152**

Kg/ml 1.433  
--- mm. 86,0

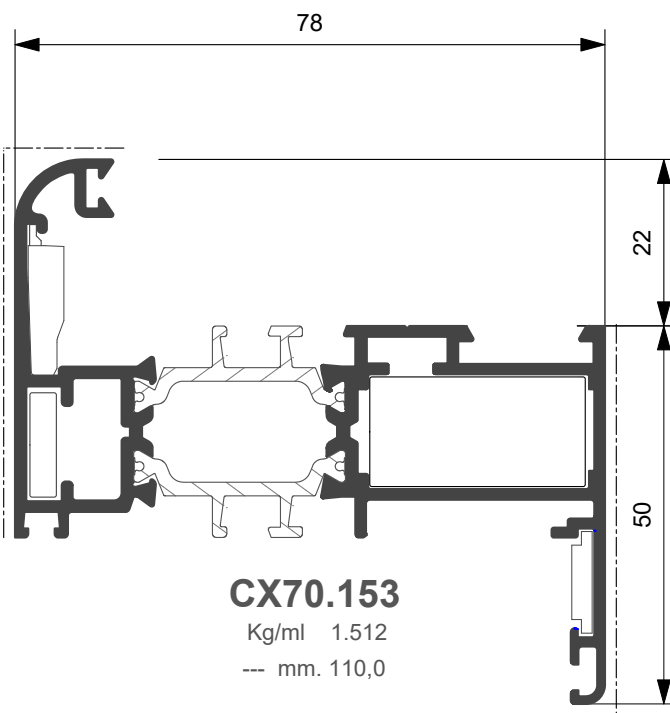

**CX70.153**

Kg/ml 1.512  
--- mm. 110,0

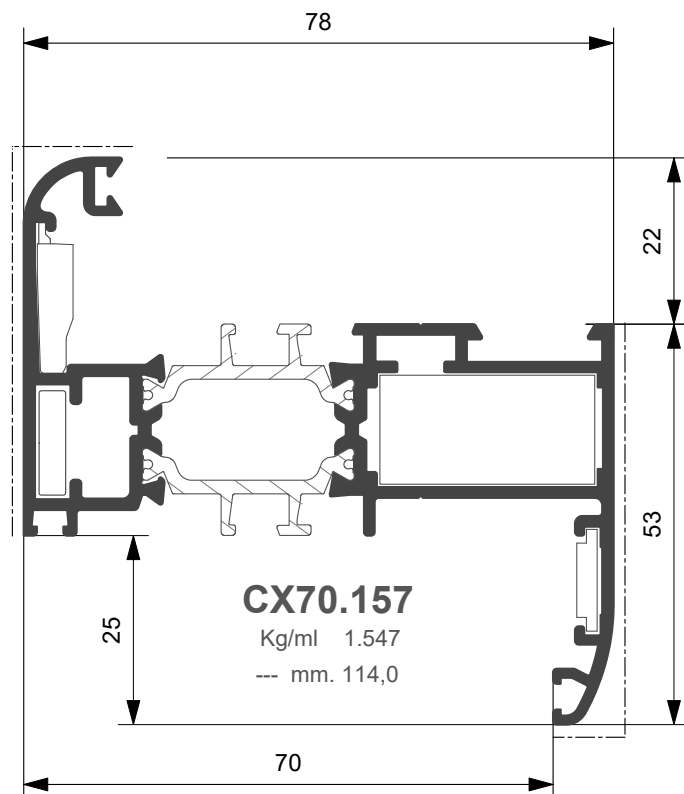

**CX70.157**

Kg/ml 1.547  
--- mm. 114,0

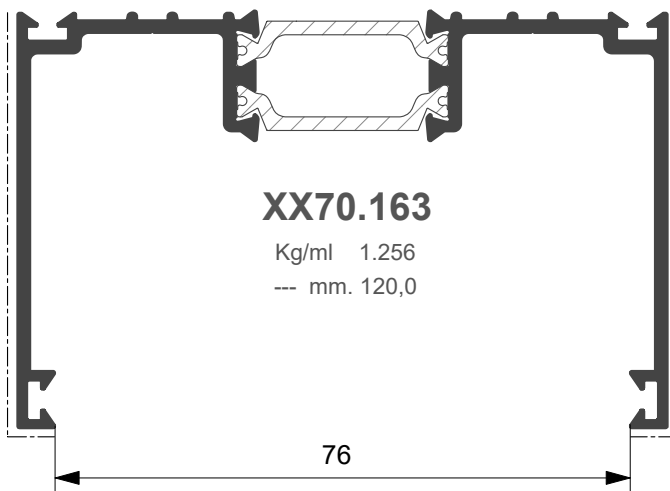

**XX70.163**

Kg/ml 1.256  
--- mm. 120,0

Profilato	Squadretta esterna		Squadretta interna			Squadretta allineamento	
	Cianfrinare	Spinare	Bottone	Cianfrinare	Spinare	Esterna	Interna
CX70.152	ARX.03.SQ	ARX.03.SQ + ARX.08.SQ	ACX.01.SQ	ARX.02.SQ	ACX.02.SQ + ARX.07.SQ	ARX.15.SQ	
CX70.153	ARX.03.SQ	ARX.03.SQ + ARX.08.SQ	ACX.01.SQ	ARX.02.SQ	ACX.02.SQ + ARX.07.SQ	ARX.15.SQ	ARX.10.SQ
CX70.157	ARX.03.SQ	ARX.03.SQ + ARX.08.SQ	ACX.01.SQ	ARX.02.SQ	ACX.02.SQ + ARX.07.SQ	ARX.15.SQ	ARX.10.SQ

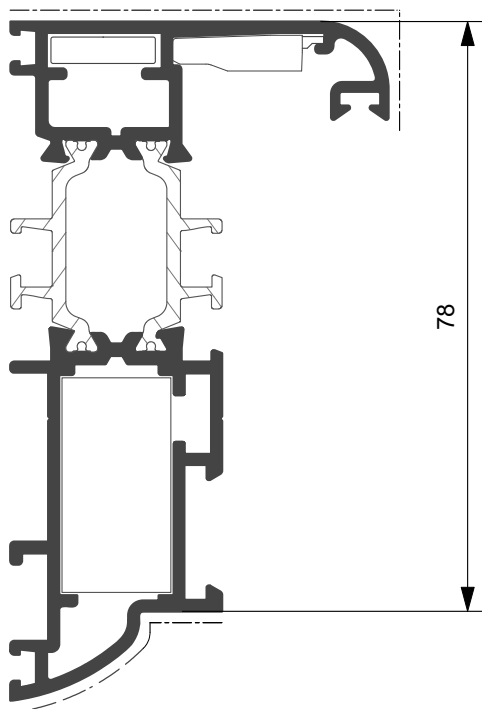

**CX70.161**

Kg/ml 1.453  
--- mm. 96,0

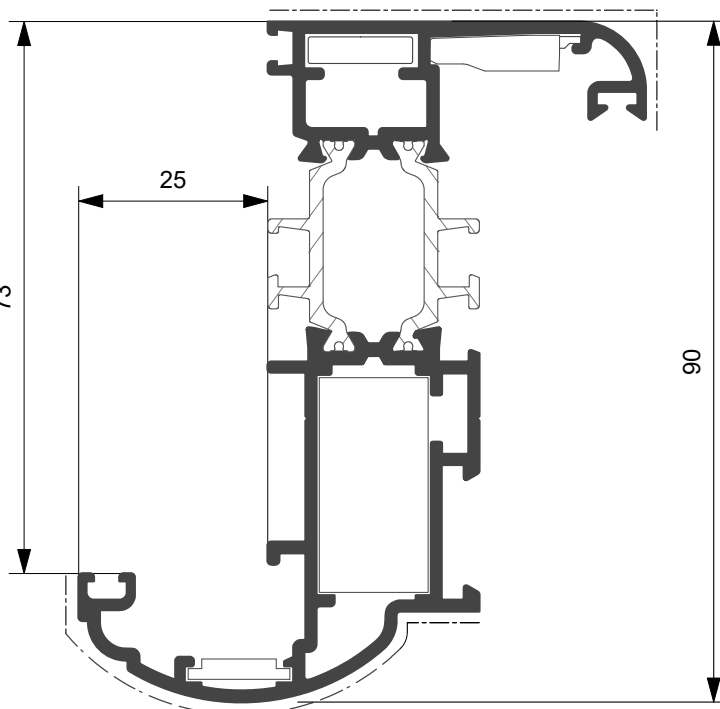

**CX70.162**

Kg/ml 1.630  
--- mm. 131,0

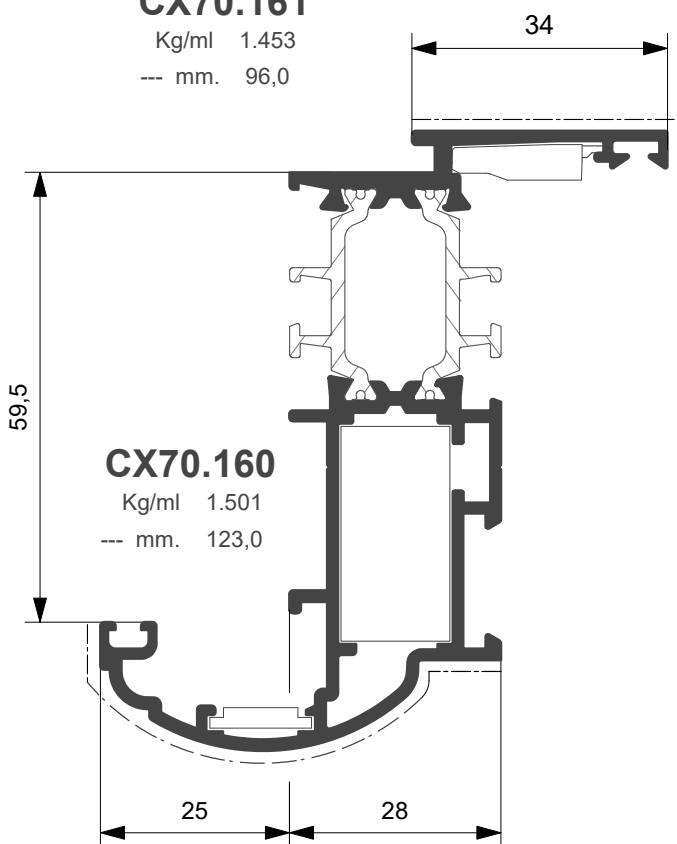

**CX70.160**

Kg/ml 1.501  
--- mm. 123,0

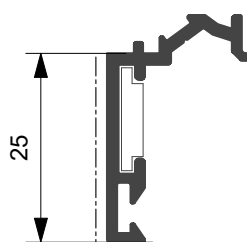

**XX70.612**

Kg/ml 0.245  
--- mm. 25,0



**XX60.635**

Kg/ml 0.306  
--- mm. 41,0

Profilato	Squadretta esterna		Squadretta interna			Squadretta allineamento	
	Cianfrinare	Spinare	Bottone	Cianfrinare	Spinare	Esterna	Interna
CX70.160			ACX.01.SQ	ARX.02.SQ	ACX.02.SQ + ARX.07.SQ	ARX.15.SQ	ARX.10.SQ
CX70.161	ARX.03.SQ	ARX.03.SQ + ARX.08.SQ	ACX.01.SQ	ARX.02.SQ	ACX.02.SQ + ARX.07.SQ	ARX.15.SQ	ARX.10.SQ
CX70.162	ARX.03.SQ	ARX.03.SQ + ARX.08.SQ	ACX.01.SQ	ARX.02.SQ	ACX.02.SQ + ARX.07.SQ	ARX.15.SQ	

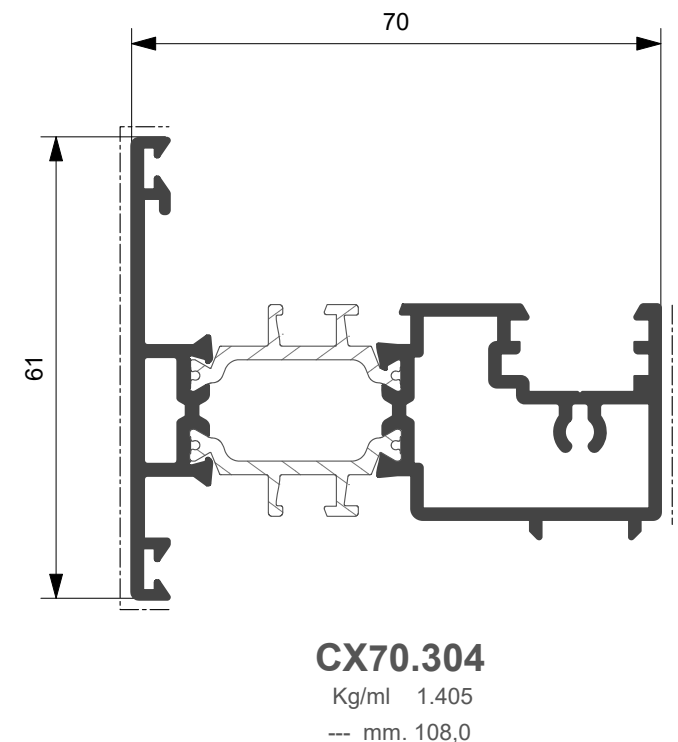
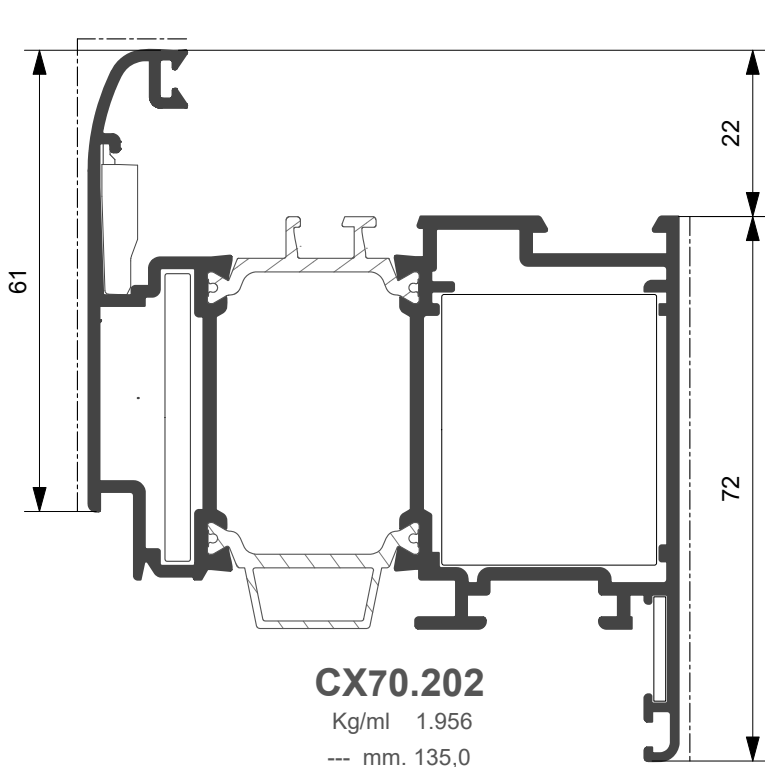
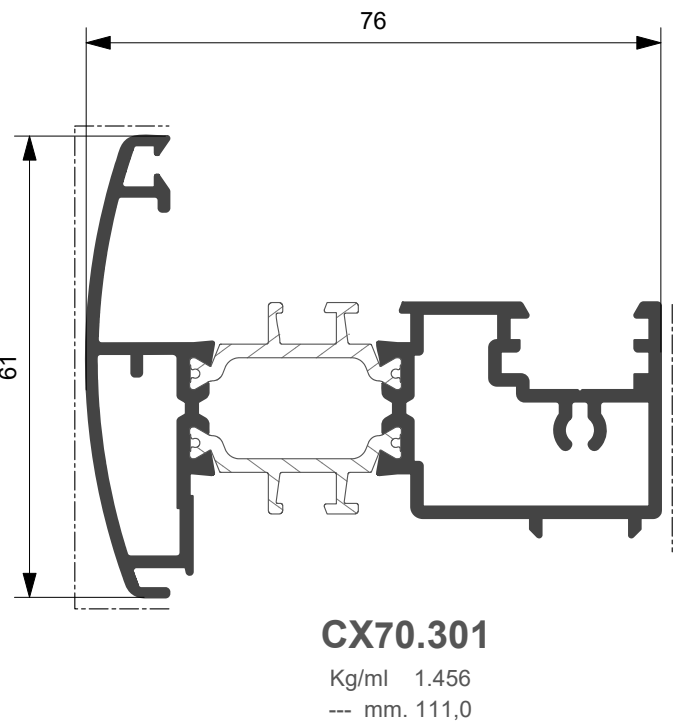
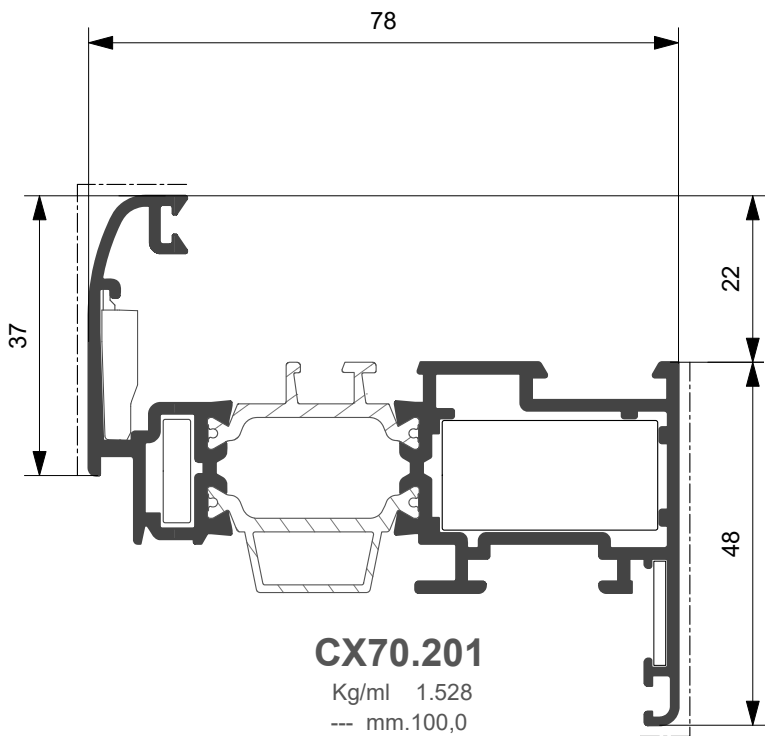

Profilato	Squadretta esterna		Squadretta interna			Squadretta allineamento	
	Cianfrinare	Spinare	Bottone	Cianfrinare	Spinare o Avvitare	Esterna	Interna
CX70.201	ARX.03.SQ	ARX.03.SQ + ARX.08.SQ	ACX.01.SQ	ACX.02.SQ	ACX.02.SQ + ARX.07.SQ	ARX.15.SQ	ARX.10.SQ
CX70.202	ARX.06.SQ	ARX.06.SQ + ARX.08.SQ	ACX.04.SQ	ACX.14.SQ	ACX.14.SQ	ARX.15.SQ	ARX.10.SQ

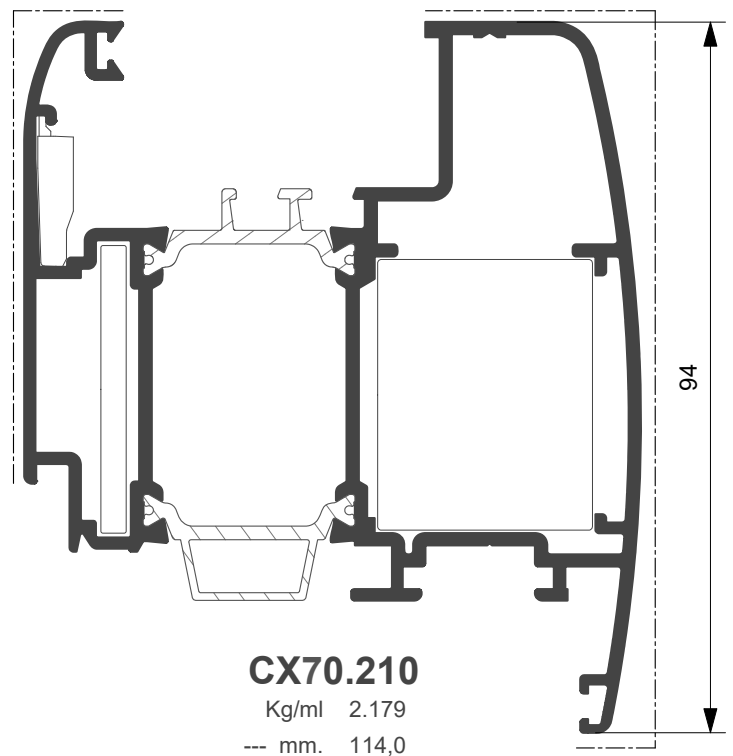
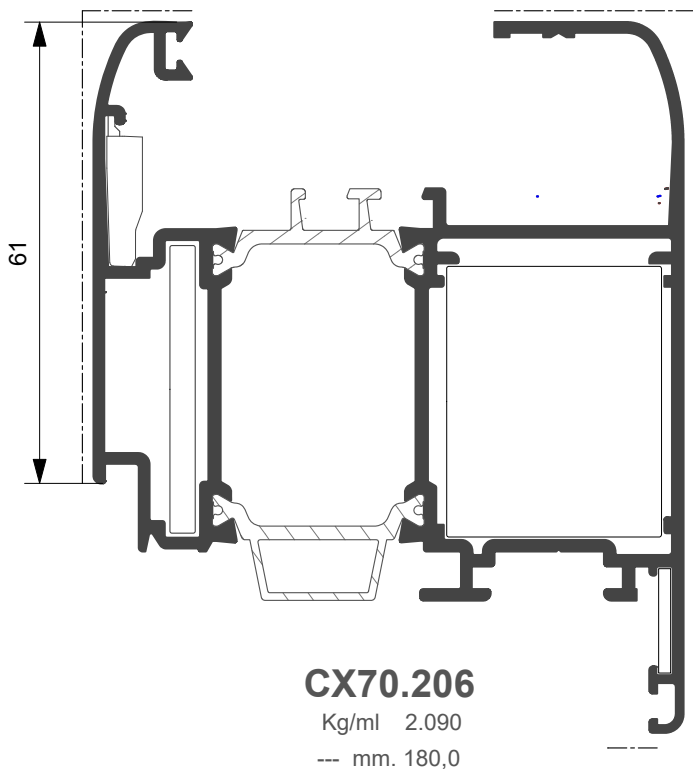
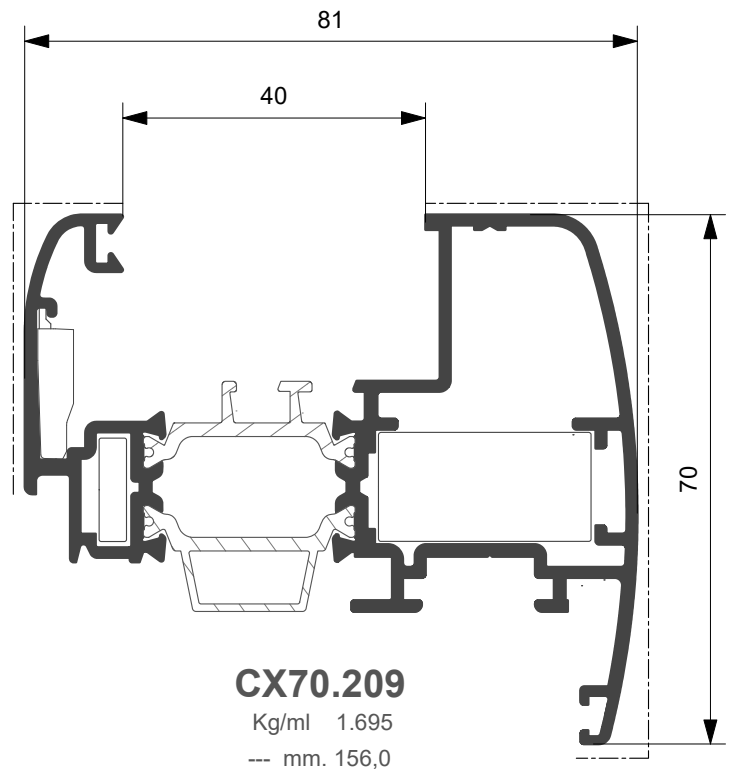
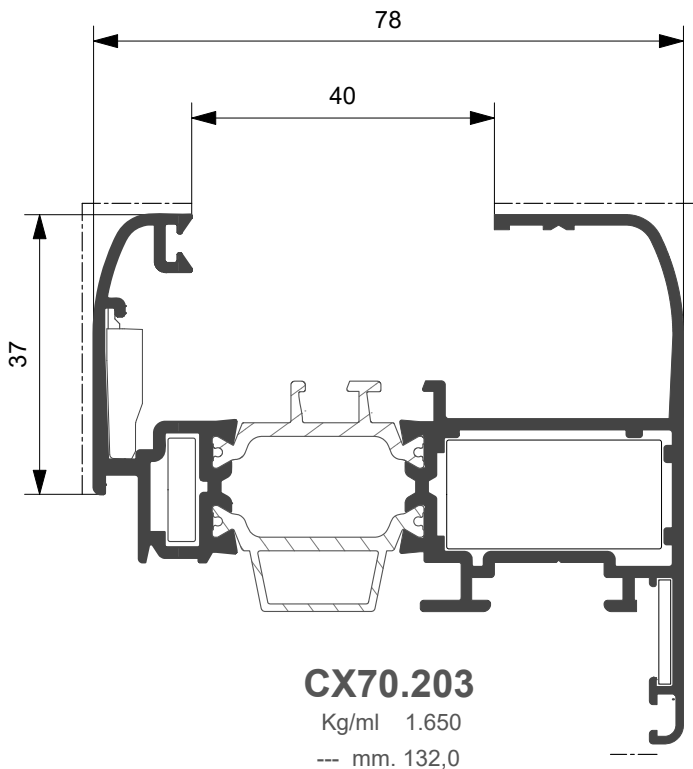

Profilato	Squadretta esterna		Squadretta interna			Squadretta allineamento	
	Cianfrinare	Spinare	Bottoni	Cianfrinare	Spinare o Avvitare	Esterna	Interna
CX70.203		ARX.03.SQ + ARX.08.SQ	ACX.01.SQ		ACX.02.SQ + ARX.07.SQ	ARX.15.SQ	ARX.10.SQ
CX70.206		ARX.06.SQ + ARX.08.SQ	ACX.04.SQ		ACX.14.SQ	ARX.15.SQ	ARX.10.SQ
CX70.209		ARX.03.SQ + ARX.08.SQ	ACX.01.SQ		ACX.02.SQ + ARX.07.SQ	ARX.15.SQ	
CX70.210		ARX.06.SQ + ARX.08.SQ	ACX.04.SQ		ACX.14.SQ	ARX.15.SQ	



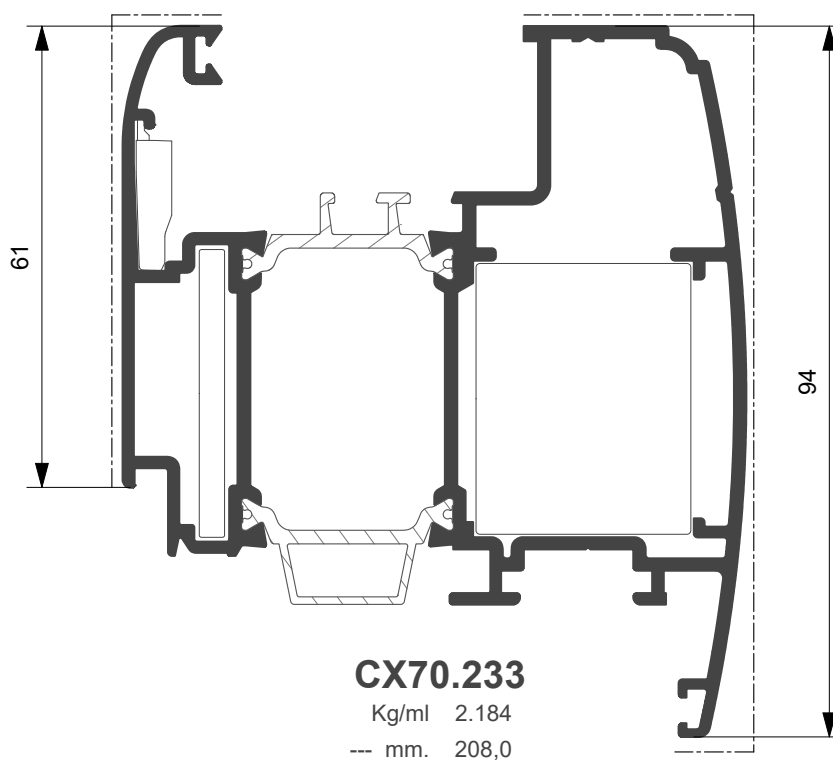
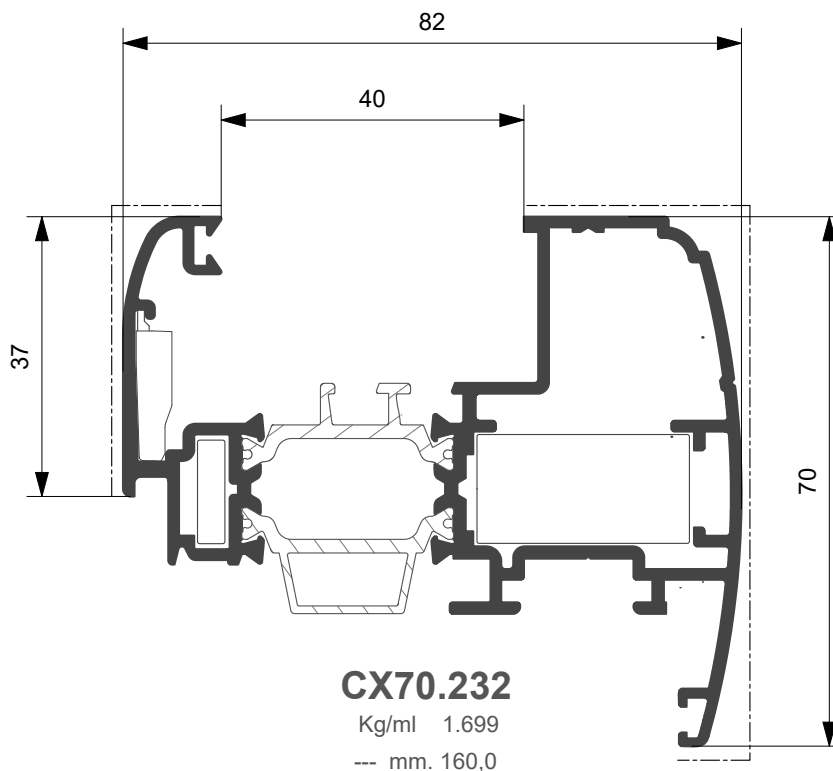

Profilato	Squadretta esterna		Squadretta interna			Squadretta allineamento	
	Cianfrinare	Spinare	Bottone	Cianfrinare	Spinare o Avvitare	Esterna	Interna
CX70.232	ARX.03.SQ	ARX.03.SQ + ARX.08.SQ	ACX.01.SQ		ACX.02.SQ + ARX.07.SQ	ARX.15.SQ	ARX.10.SQ
CX70.233	ARX.06.SQ	ARX.06.SQ + ARX.08.SQ	ACX.04.SQ		ACX.14.SQ	ARX.15.SQ	ARX.10.SQ

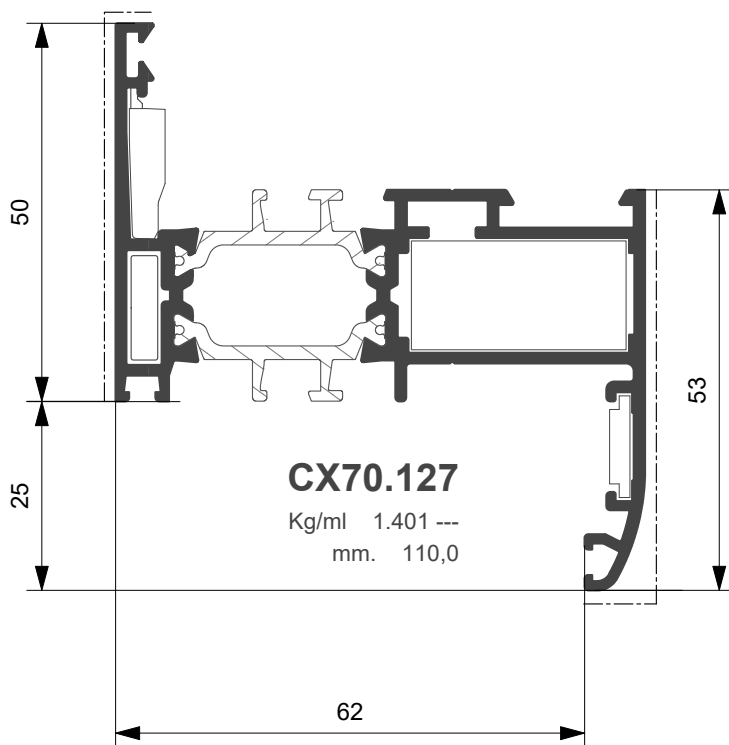
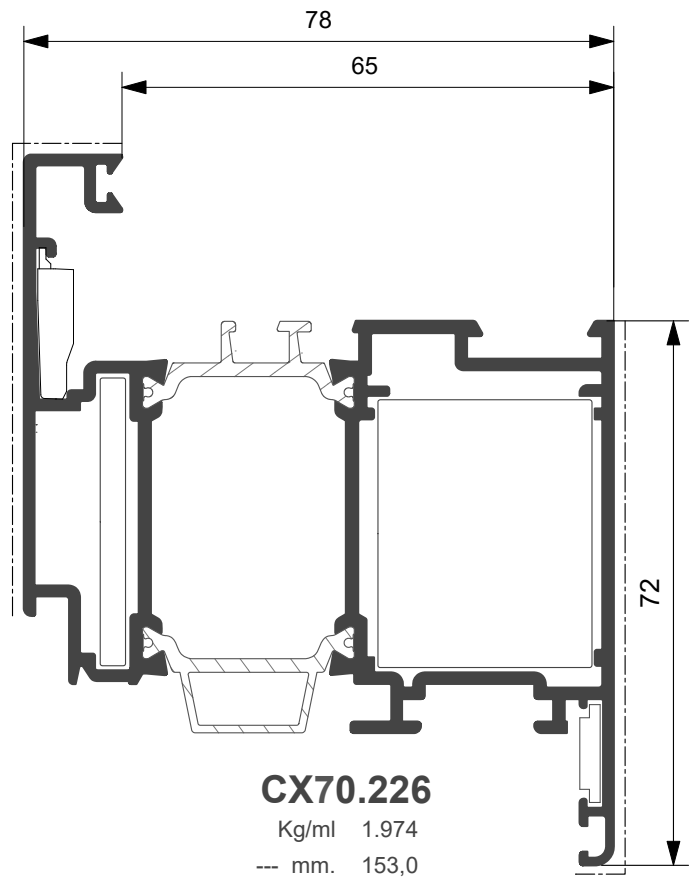
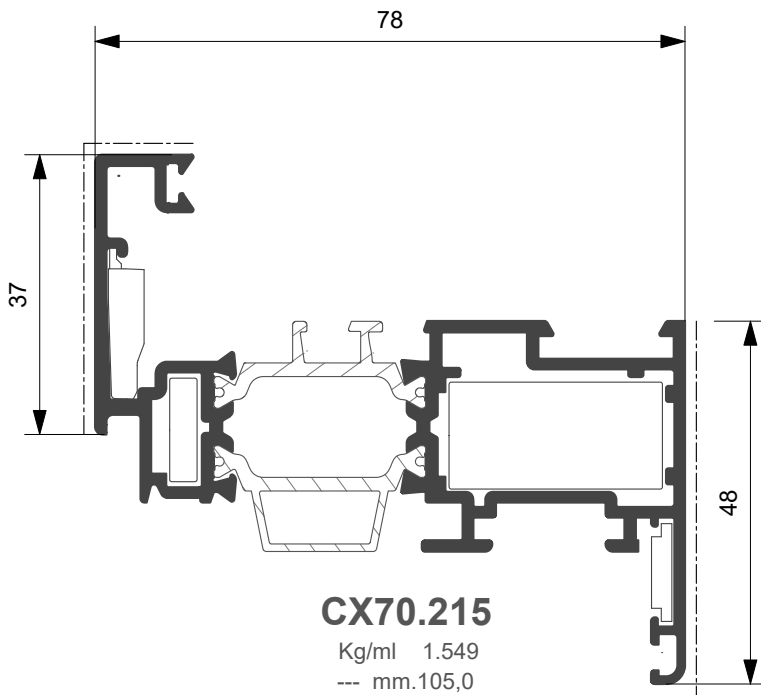

Profilato	Squadretta esterna		Squadretta interna			Squadretta allineamento	
	Cianfrinare	Spinare o Avvitare	Bottone	Cianfrinare	Spinare	Esterna	Interna
CX70.127	ARX.03.SQ	ARX.03.SQ + ARX.08.SQ	ACX.01.SQ		ACX.02.SQ + ARX.07.SQ	ARX.15.SQ	ARX.10.SQ
CX70.215	ARX.03.SQ	ARX.03.SQ + ARX.08.SQ	ACX.01.SQ		ACX.02.SQ + ARX.07.SQ	ARX.15.SQ	ARX.10.SQ
CX70.226	ARX.06.SQ	ARX.06.SQ + ARX.08.SQ	ACX.04.SQ	ACX.14.SQ	ACX.14.SQ	ARX.15.SQ	ARX.10.SQ

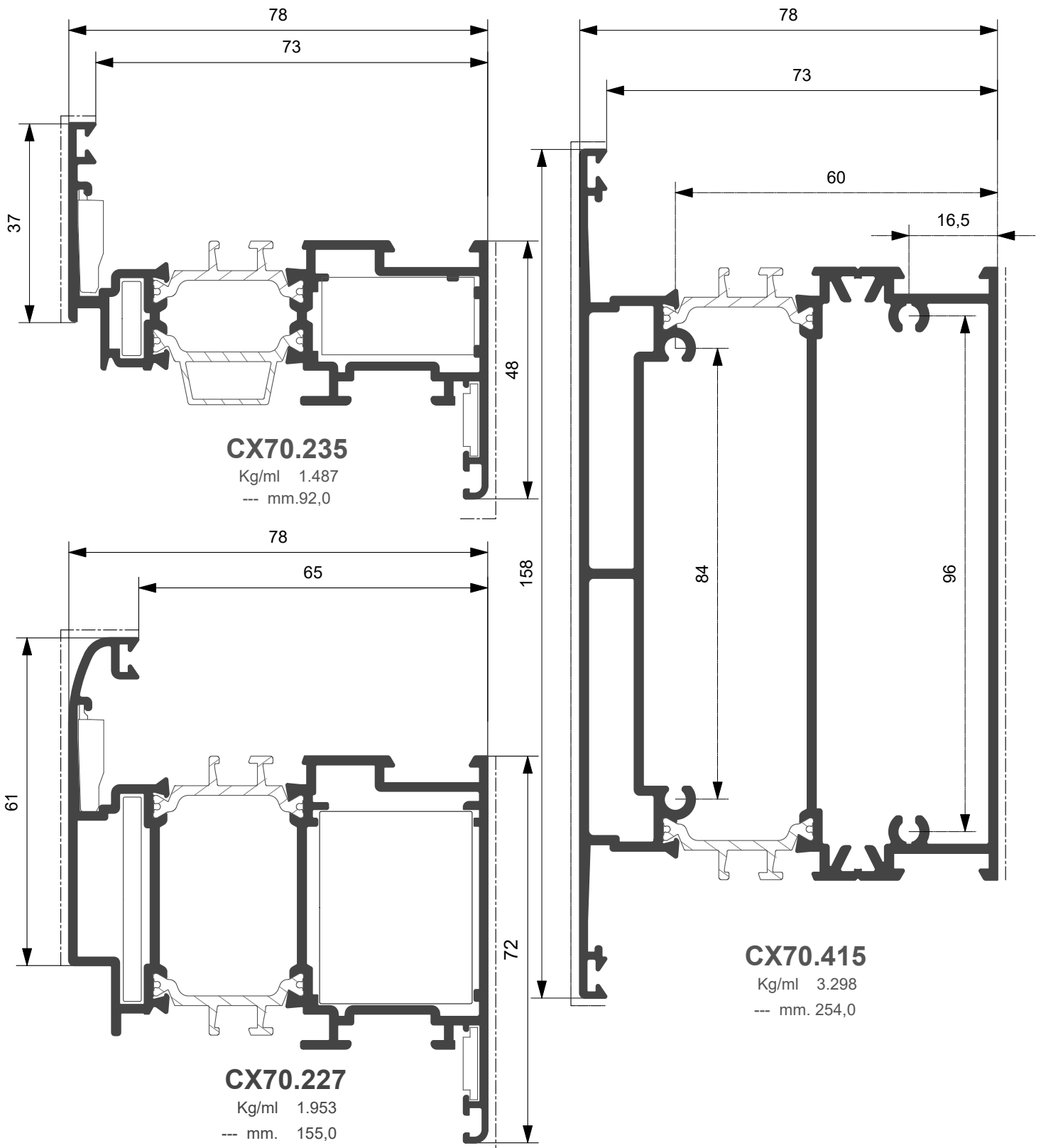

Profilato	Squadretta esterna		Squadretta interna			Squadretta allineamento	
	Cianfrinare	Spinare o Avvitare	Bottone	Cianfrinare	Spinare	Esterna	Interna
CX70.227	ARX.06.SQ	ARX.06.SQ + ARX.08.SQ	ACX.04.SQ	ACX.14.SQ	ACX.14.SQ	ARX.15.SQ	ARX.10.SQ
CX70.235	ARX.03.SQ	ARX.03.SQ + ARX.08.SQ	ACX.01.SQ		ACX.02.SQ + ARX.07.SQ	ARX.15.SQ	ARX.10.SQ



**Ferramenta a nastro**

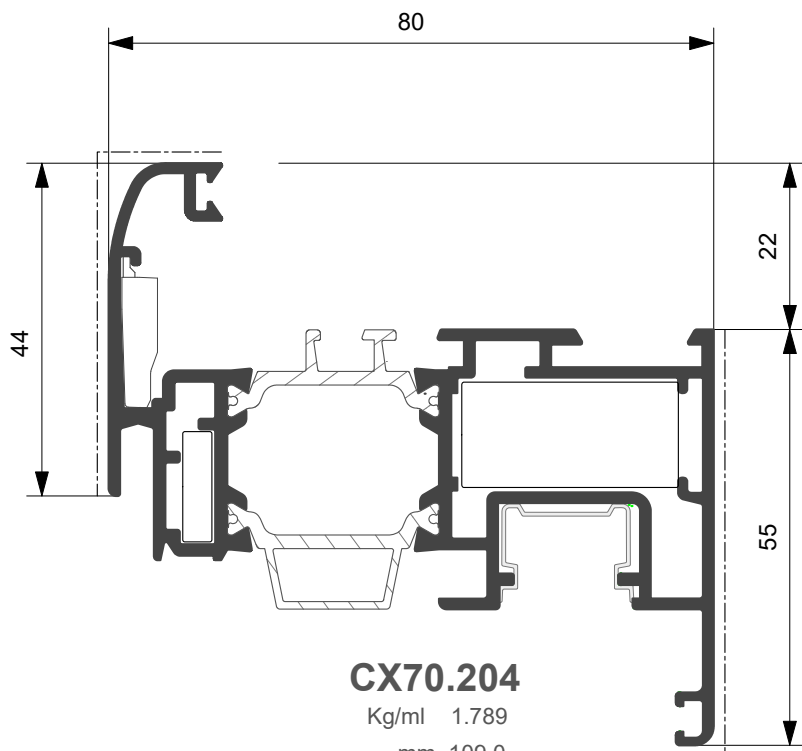

**CX70.204**

Kg/ml 1.789

--- mm. 109,0

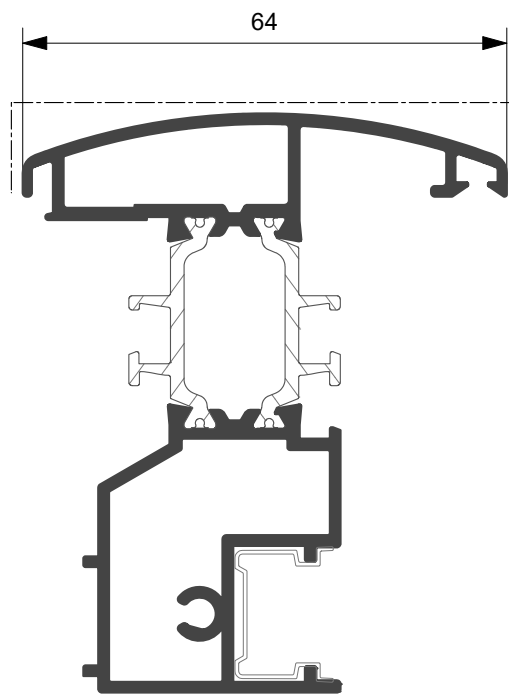

**XX70.302**

Kg/ml 1.462

--- mm. 106,0

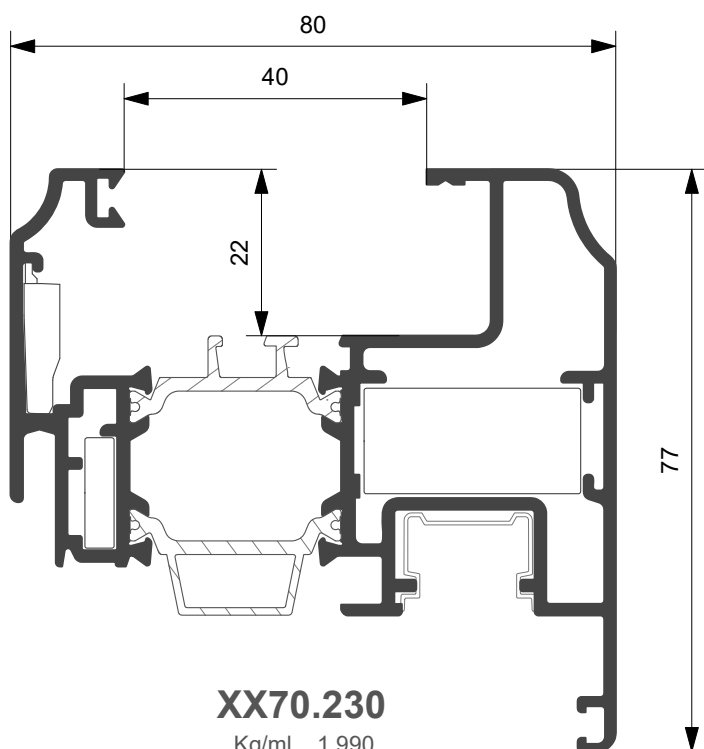

**XX70.230**

Kg/ml 1.990

--- mm. 159,0

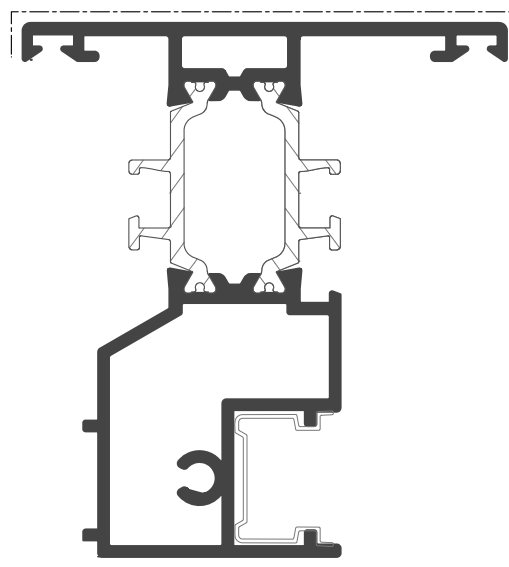

**XX70.308**

Kg/ml 1.409

--- mm. 101,0

Profilato	Squadretta esterna		Squadretta interna			Squadretta allineamento	
	Cianfrinare	Spinare	Bottone	Cianfrinare	Spinare	Esterna	Interna
CX70.204	ARX.03.SQ	ARX.03.SQ + ARX.08.SQ	ACX.01.SQ	ACX.02.SQ	ACX.02.SQ + ARX.07.SQ	ARX.15.SQ	
XX70.230	ARX.03.SQ	ARX.03.SQ + ARX.08.SQ	ACX.01.SQ	ACX.02.SQ	ACX.02.SQ + ARX.07.SQ	ARX.15.SQ	

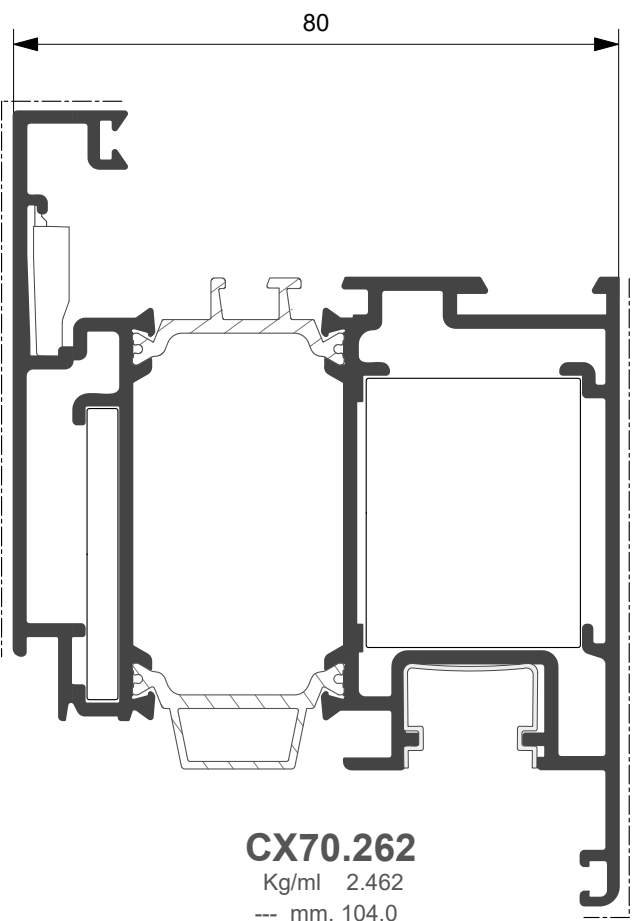
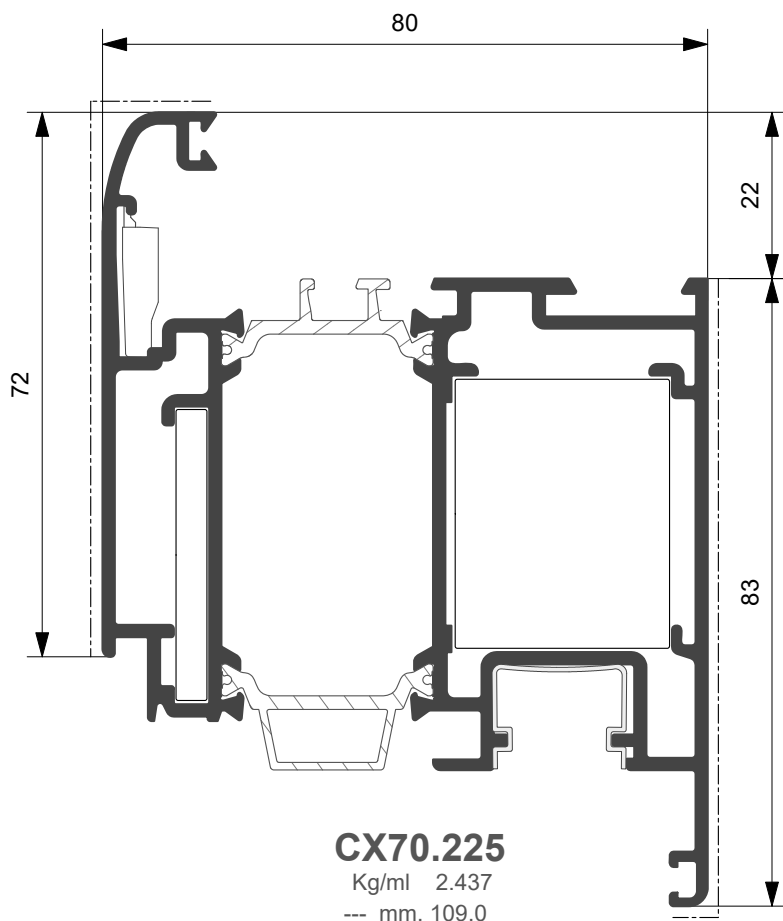
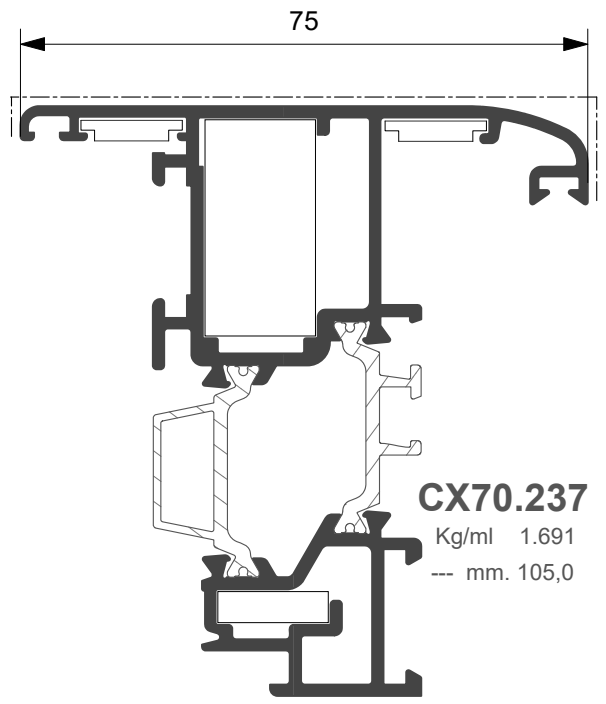
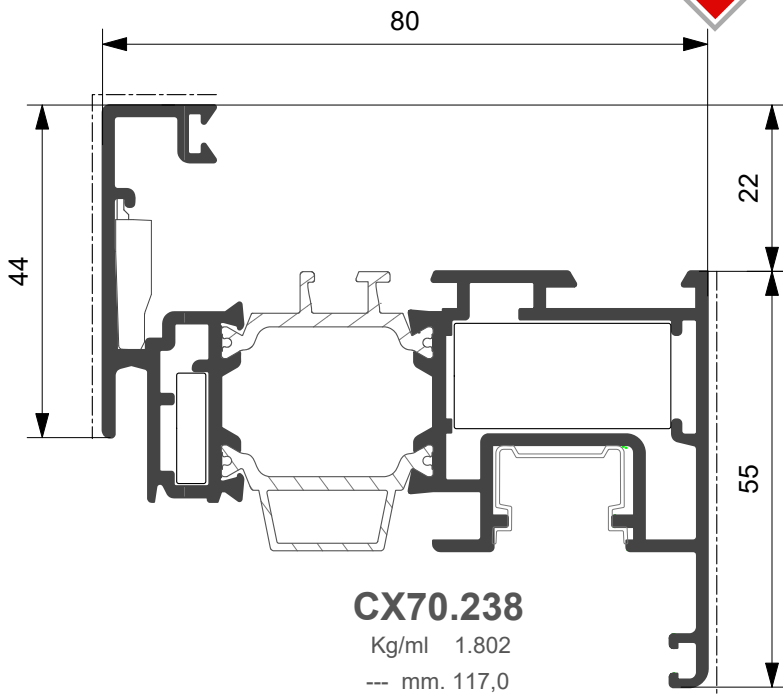

Profilato	Squadretta esterna		Squadretta interna			Squadretta allineamento	
	Cianfrinare	Spinare	Bottone	Cianfrinare	Spinare	Esterna	Interna
CX70.225	ARX.06.SQ	ARX.06.SQ + ARX.08.SQ	ACX.04.SQ		ACX.14.SQ	ARX.15.SQ	
CX70.237	ARX.03.SQ	ARX.03.SQ + ARX.08.SQ	ACX.01.SQ	ACX.02.SQ	ACX.02.SQ + ARX.07.SQ	ARX.15.SQ	
CX70.238	ARX.03.SQ	ARX.03.SQ + ARX.08.SQ	ACX.01.SQ	ACX.02.SQ	ACX.02.SQ + ARX.07.SQ	ARX.10.SQ	
CX70.262	ARX.06.SQ	ARX.06.SQ + ARX.08.SQ	ACX.04.SQ		ACX.14.SQ	ARX.15.SQ	



Ante sormonto 10 mm.

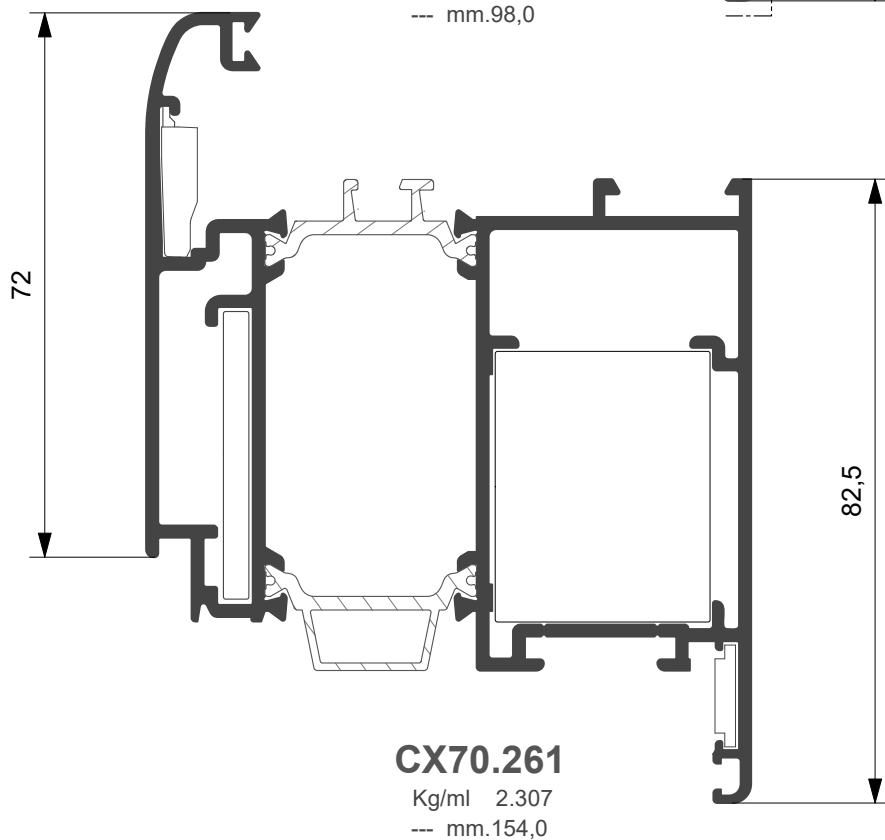
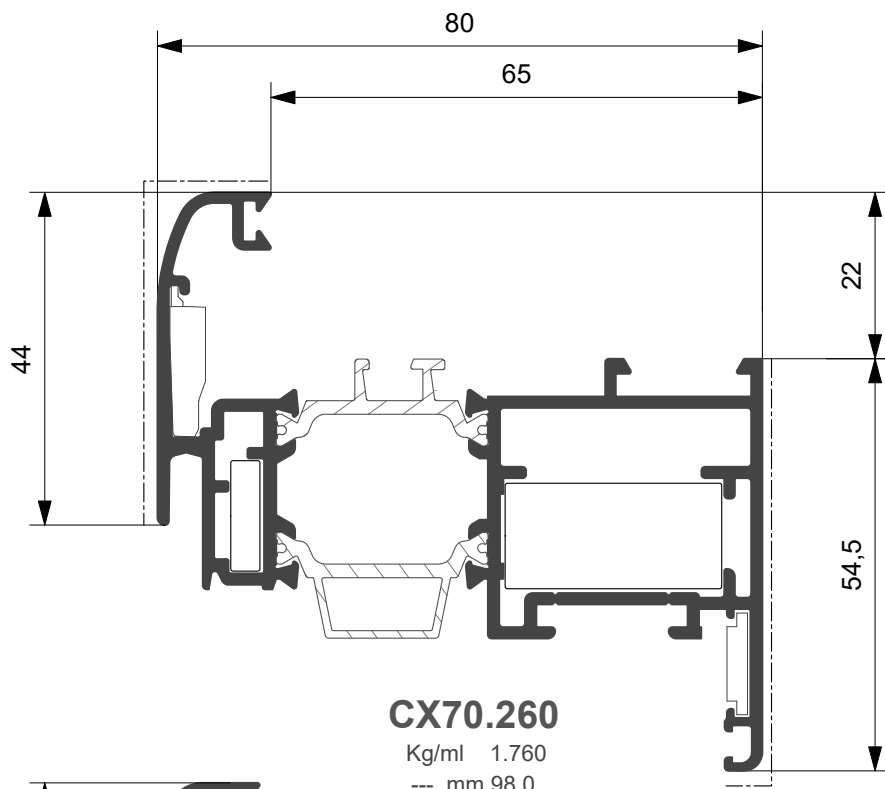

Profilato	Squadretta esterna		Squadretta interna			Squadretta allineamento	
	Cianfrinare	Spinare o Avvitare	Bottone	Cianfrinare	Spinare	Esterna	Interna
CX70.260	ARX.03.SQ	ARX.03.SQ + ARX.08.SQ	ACX.01.SQ		ACX.02.SQ + ARX.07.SQ	ARX.15.SQ	ARX.10.SQ
CX70.261	ARX.06.SQ	ARX.06.SQ + ARX.08.SQ	ACX.04.SQ	ACX.14.SQ	ACX.14.SQ	ARX.15.SQ	ARX.10.SQ

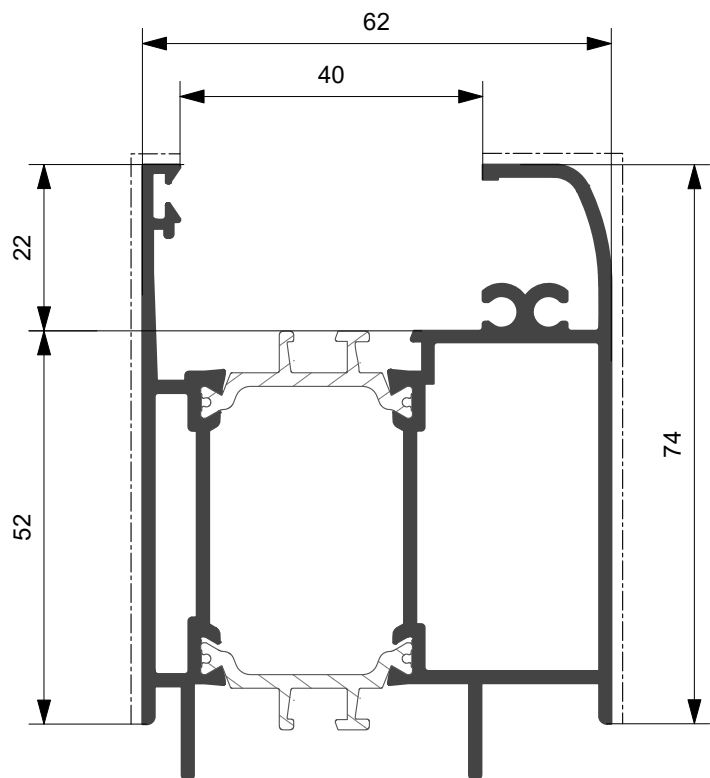

**XX70.407**

Kg/ml 1.884  
--- mm. 162,0

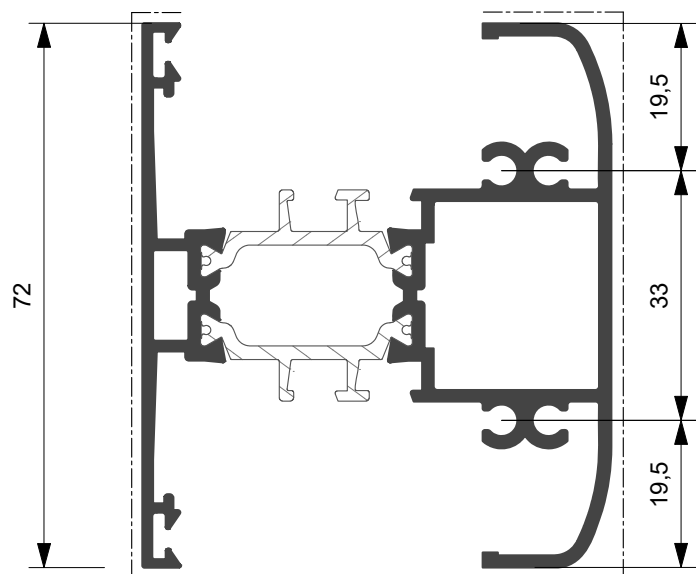

**XX70.405**

Kg/ml 1.729  
--- mm. 1700

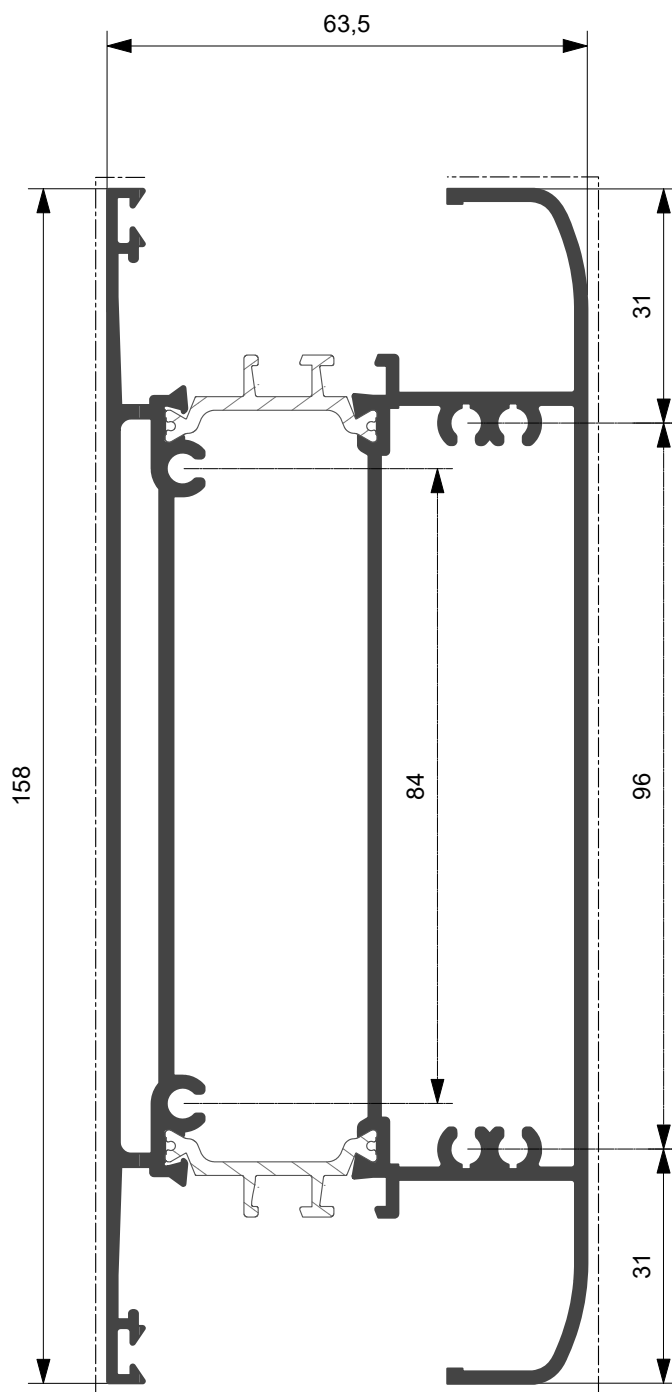

**XX70.406**

Kg/ml 3.352  
--- mm. 332,0

Profilato	Squadretta esterna		Squadretta interna			Squadretta allineamento	
	Cianfrinare	Spinare	Bottono	Cianfrinare	Spinare	Esterna	Interna

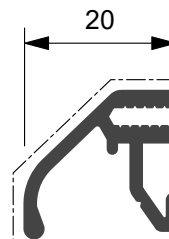
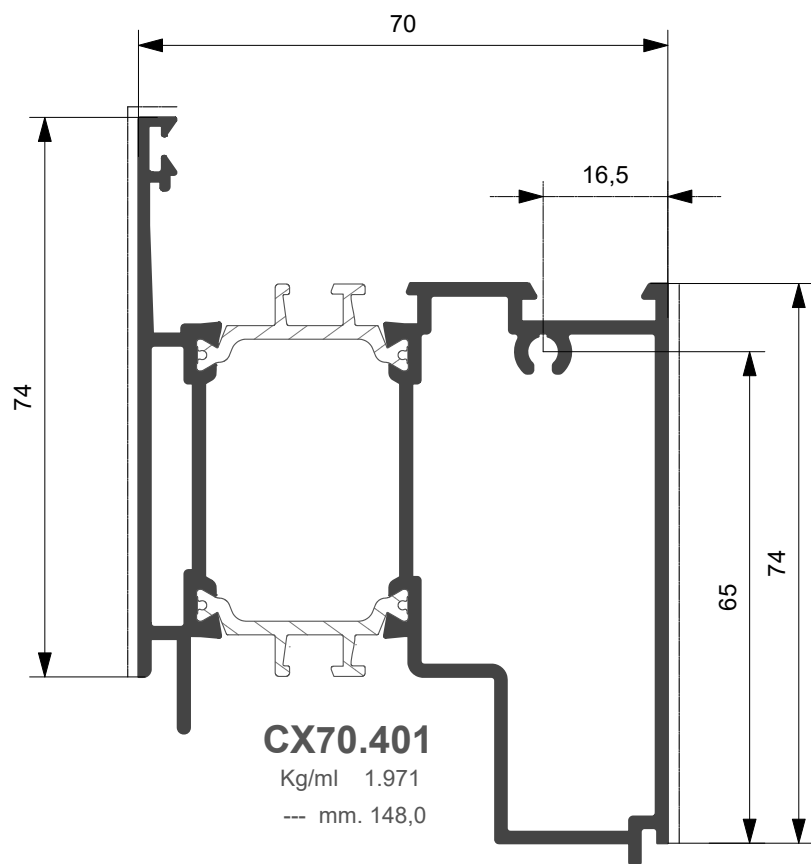

**XX70.601**  
Kg/ml 0.269  
--- mm. 28,0

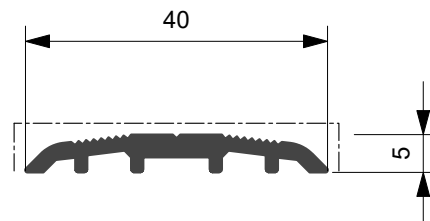

**XX70.603**  
Kg/ml 0.275  
--- mm. 40,0

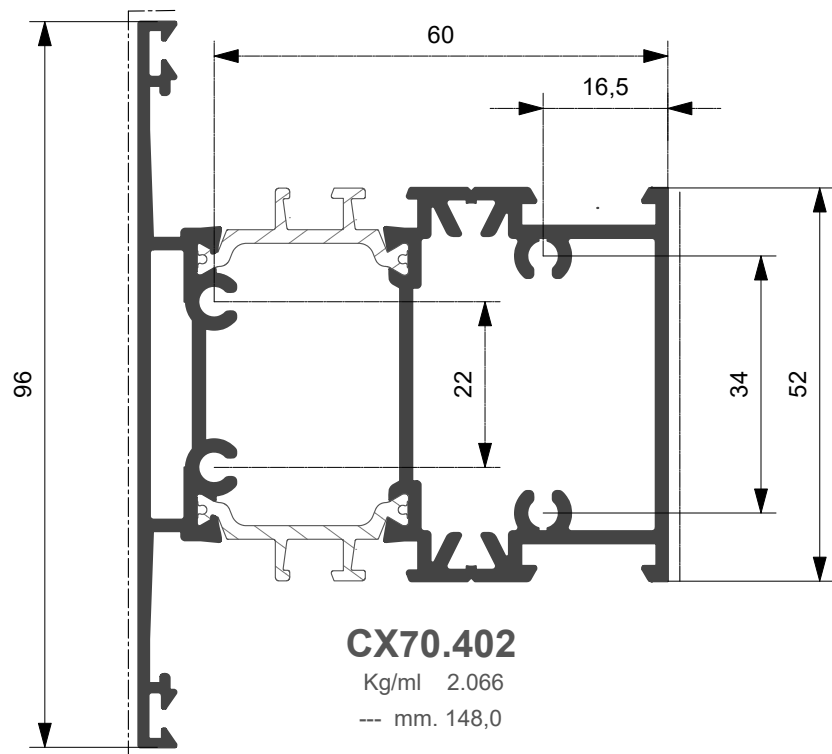

**XX70.602**  
Kg/ml 0.372  
--- mm. 22,0

Profilato	Squadretta esterna		Squadretta interna			Squadretta allineamento	
	Cianfrinare	Spinare	Bottone	Cianfrinare	Spinare	Esterna	Interna



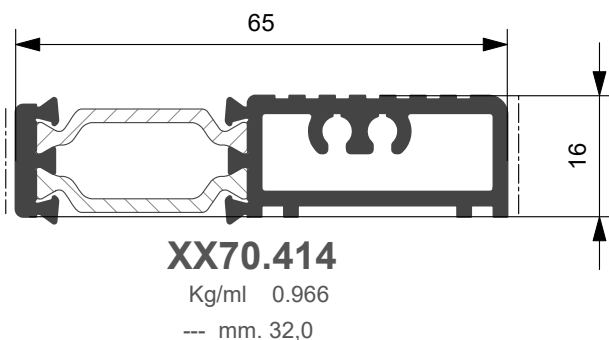
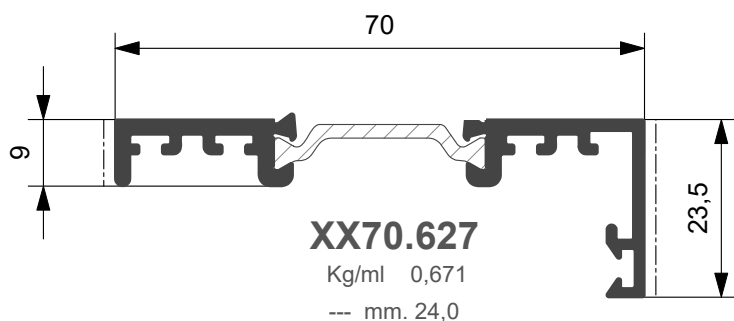
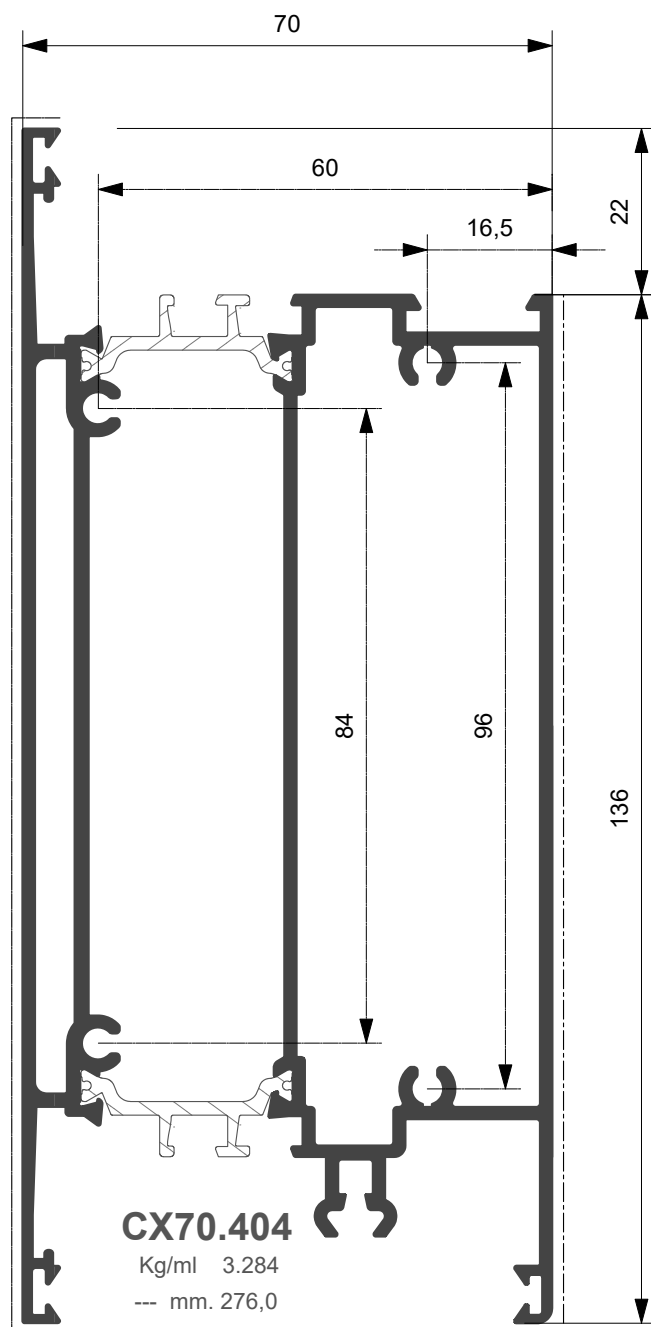
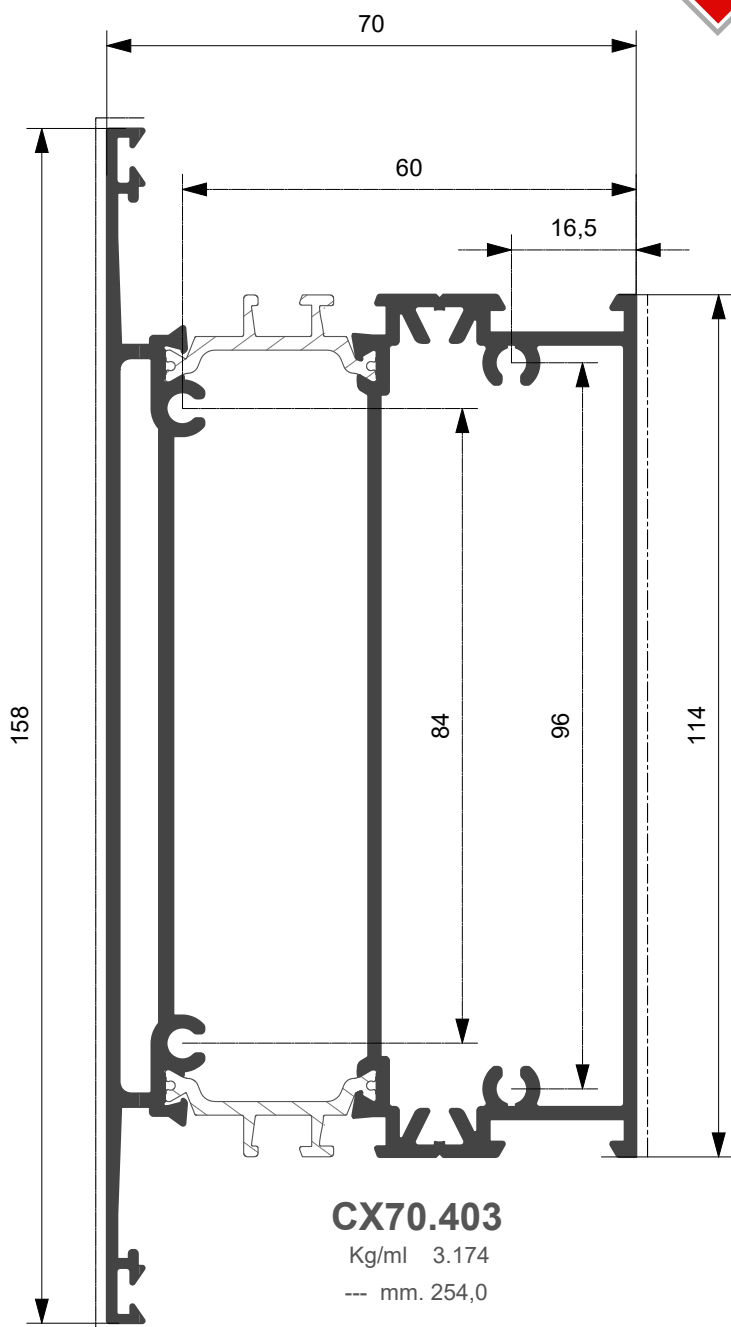

Profilato	Squadretta esterna		Squadretta interna			Squadretta allineamento	
	Cianfrinare	Spinare	Bottone	Cianfrinare	Spinare	Esterna	Interna

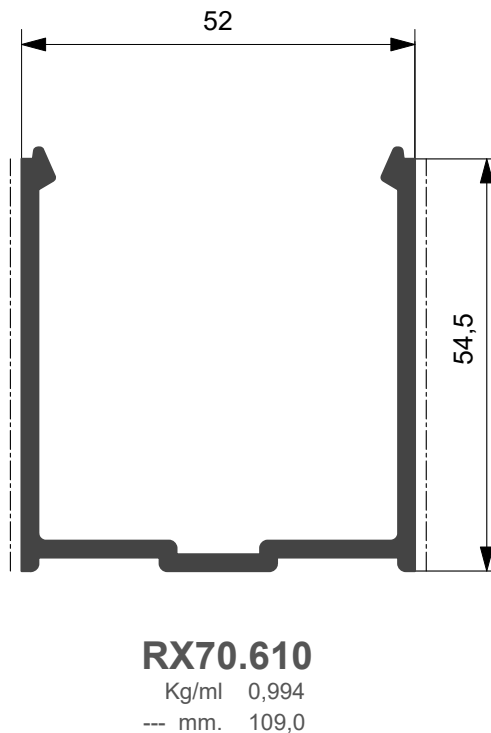
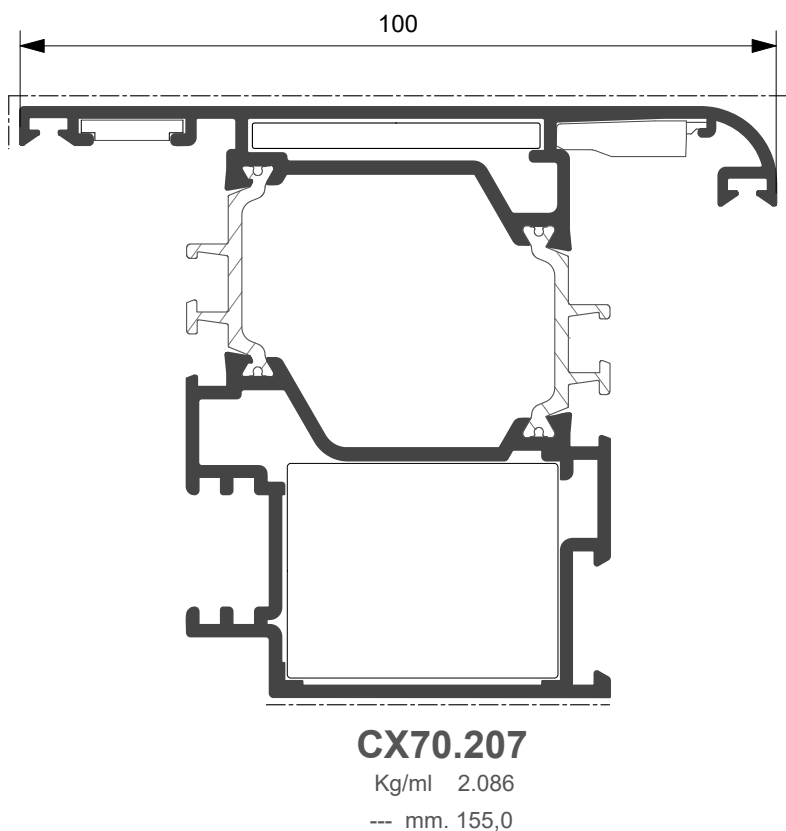
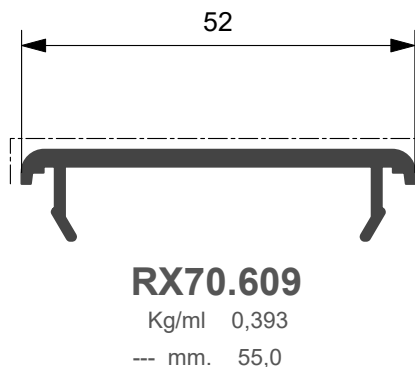
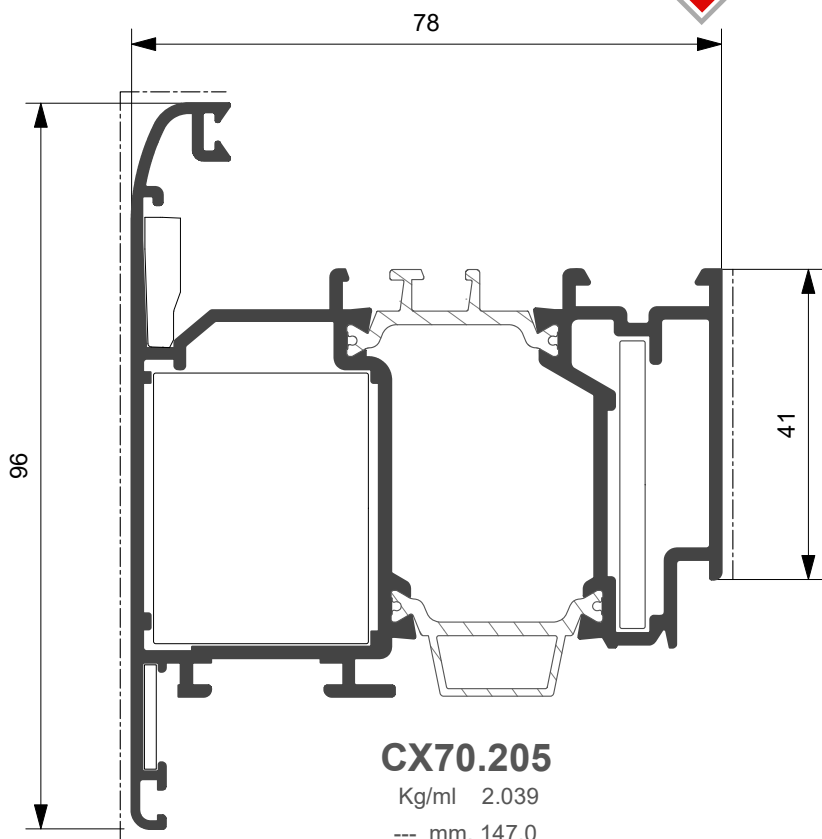

Profilato	Squadretta esterna		Squadretta interna			Squadretta allineamento	
	Cianfrinare	Spinare	Bottono	Cianfrinare	Spinare	Esterna	Interna
CX70.205	ARX.06.SQ	ARX.06.SQ + ARX.08.SQ	ACX.04.SQ			ARX.09.SQ	ARX.10.SQ
CX70.207	ARX.06.SQ		ACX.04.SQ			ARX.09.SQ	ARX.10.SQ

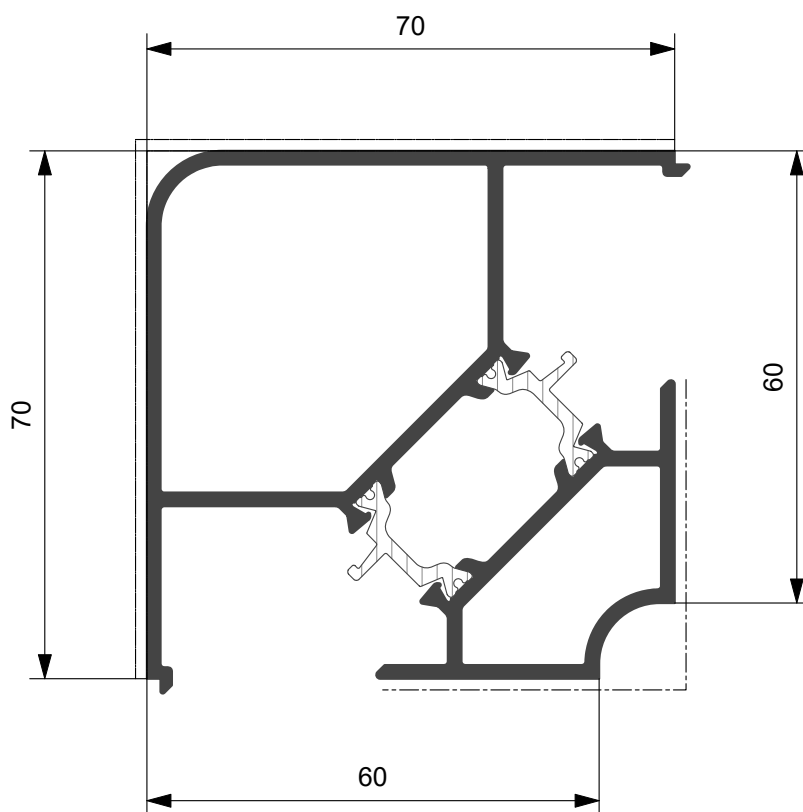

**XX70.613**

Kg/ml 1,885  
--- mm. 215,0

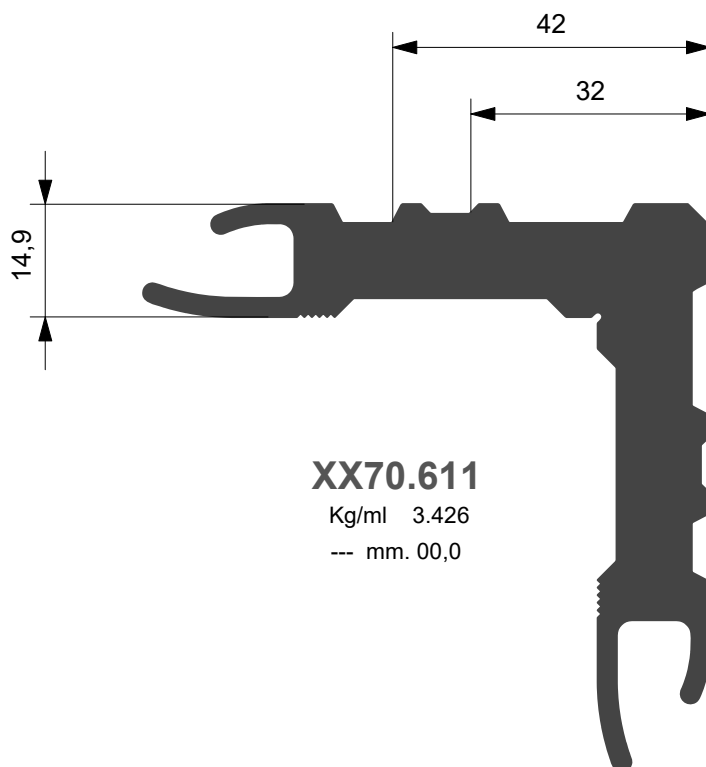

**XX70.611**

Kg/ml 3.426  
--- mm. 00,0

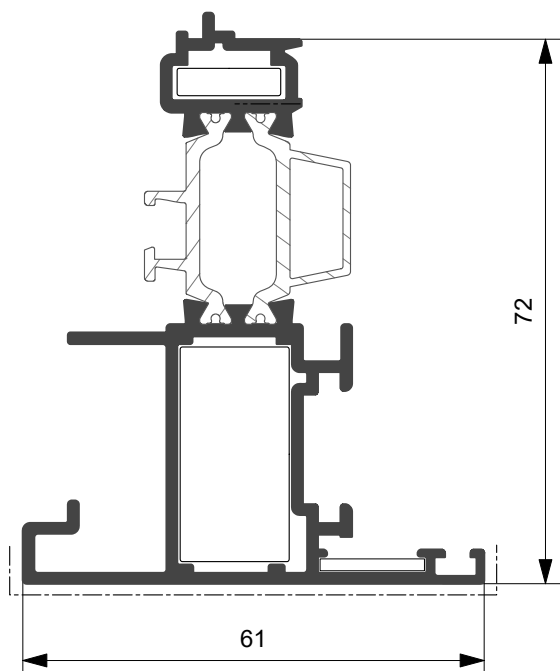

**CX70.303**

Kg/ml 1.367

--- mm. 64,0

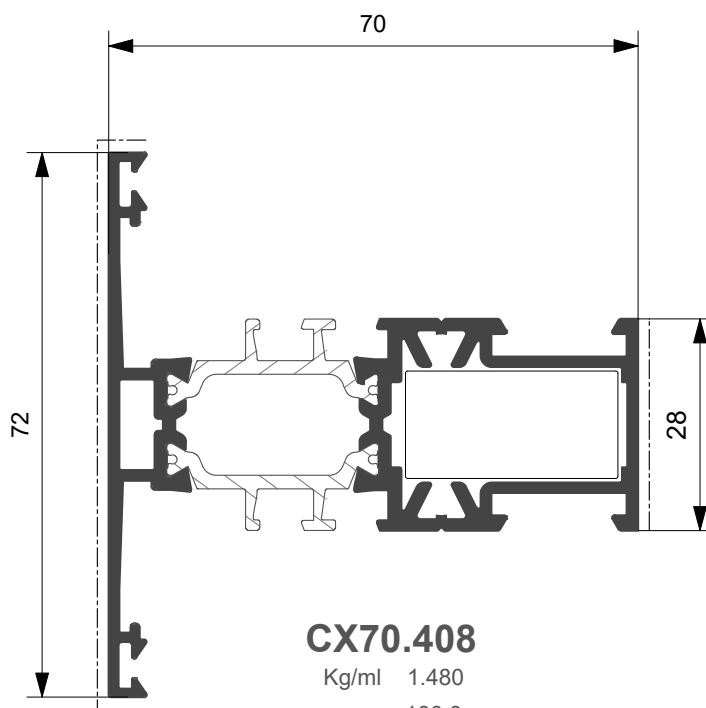

**CX70.408**

Kg/ml 1.480

--- mm. 100,0

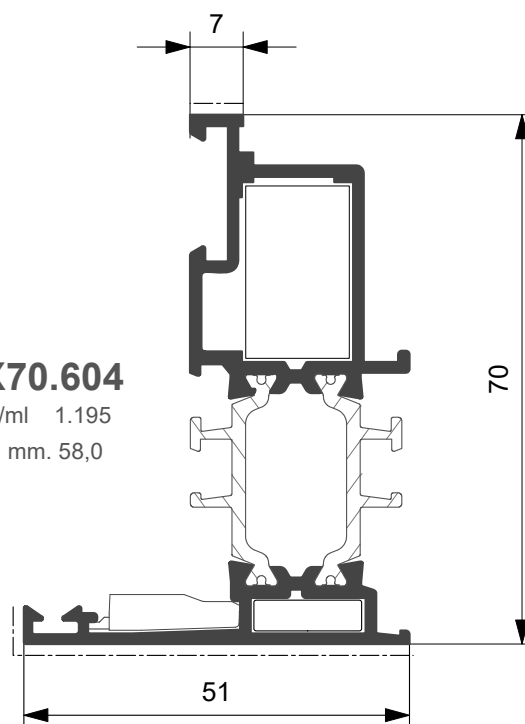

**CX70.604**

Kg/ml 1.195

--- mm. 58,0

Profilato	Squadretta esterna		Squadretta interna			Squadretta allineamento	
	Cianfrinare	Spinare	Bottone	Cianfrinare	Spinare	Esterna	Interna
CX70.303	ARX.03.SQ	ARX.03.SQ + ARX.08.SQ	ACX.01.SQ	ACX.02.SQ	ACX.02.SQ + ARX.07.SQ		ARX.10.SQ
CX70.604	ARX.03.SQ	ARX.06.SQ + ARX.08.SQ	ARX.13.SQ			ARX.15.SQ	

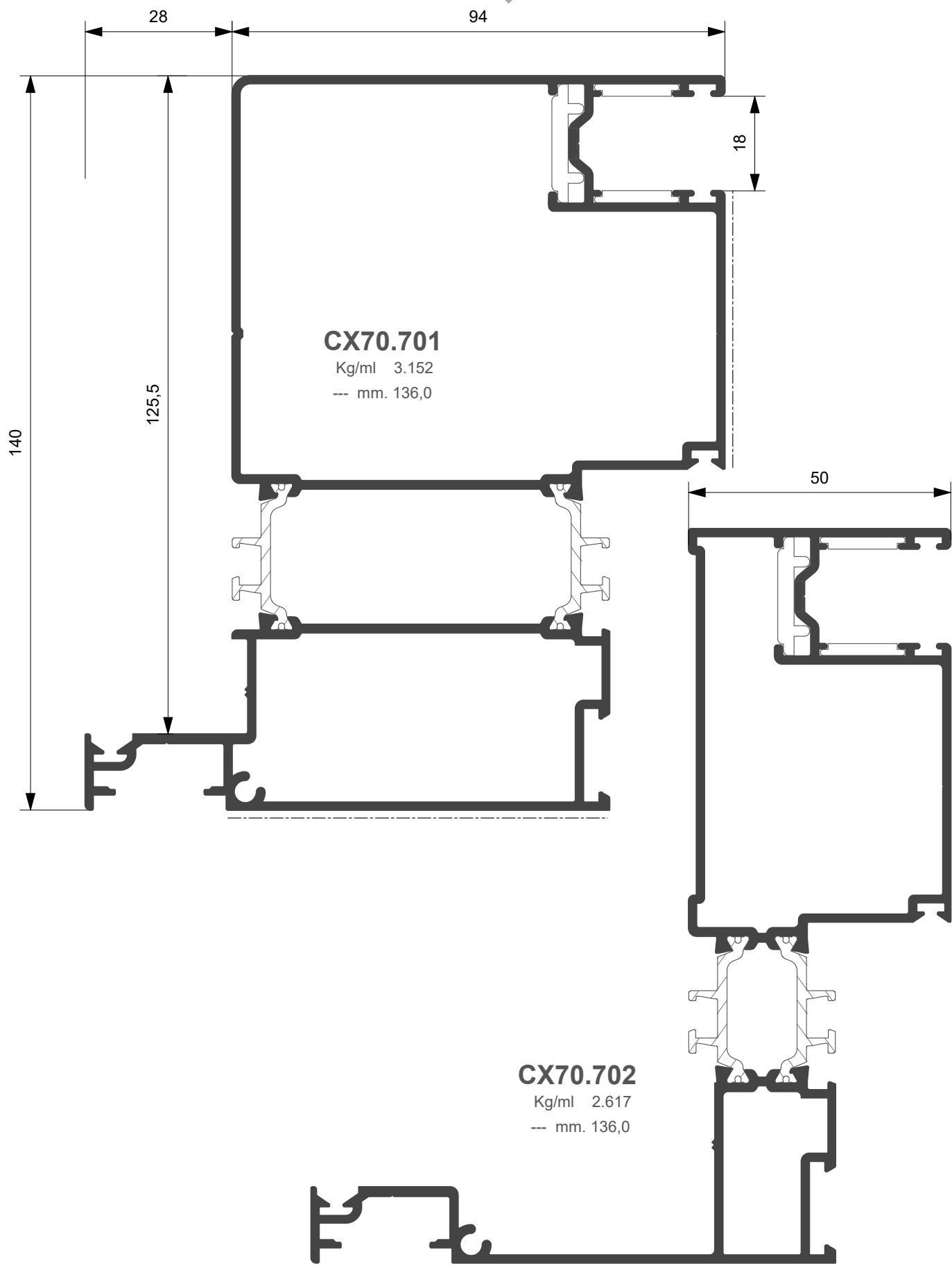

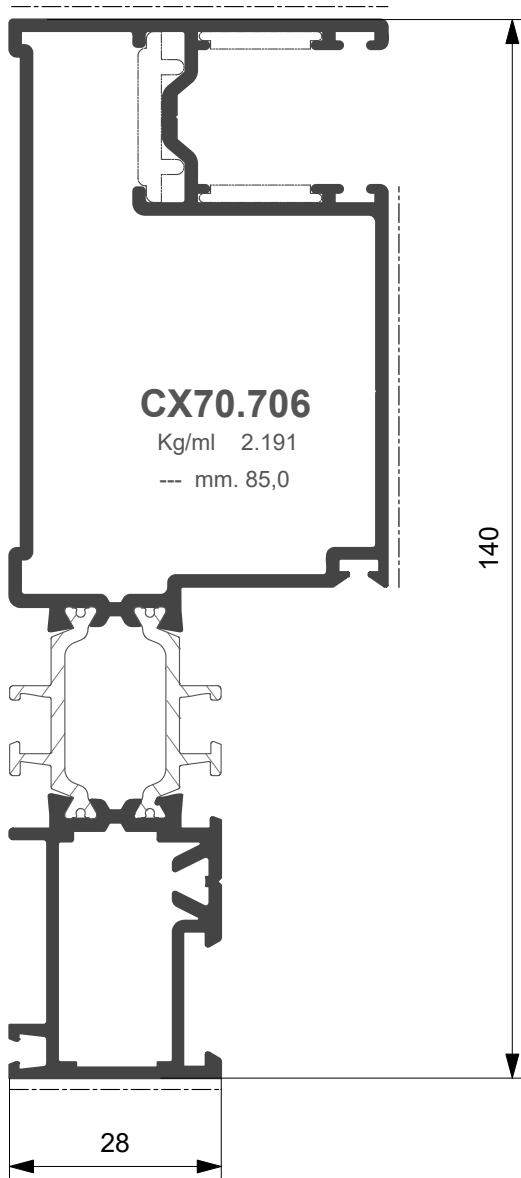

**XX70.705**  
Kg/ml 0.155  
--- mm. 000,0

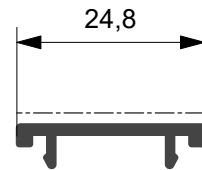

**XX70.704**  
Kg/ml 0.135  
--- mm. 25,0

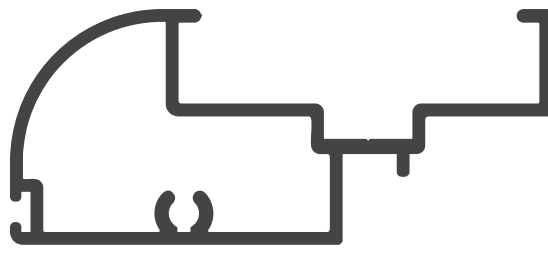

**XX70.703**  
Kg/ml 0.791  
--- mm. 43,0

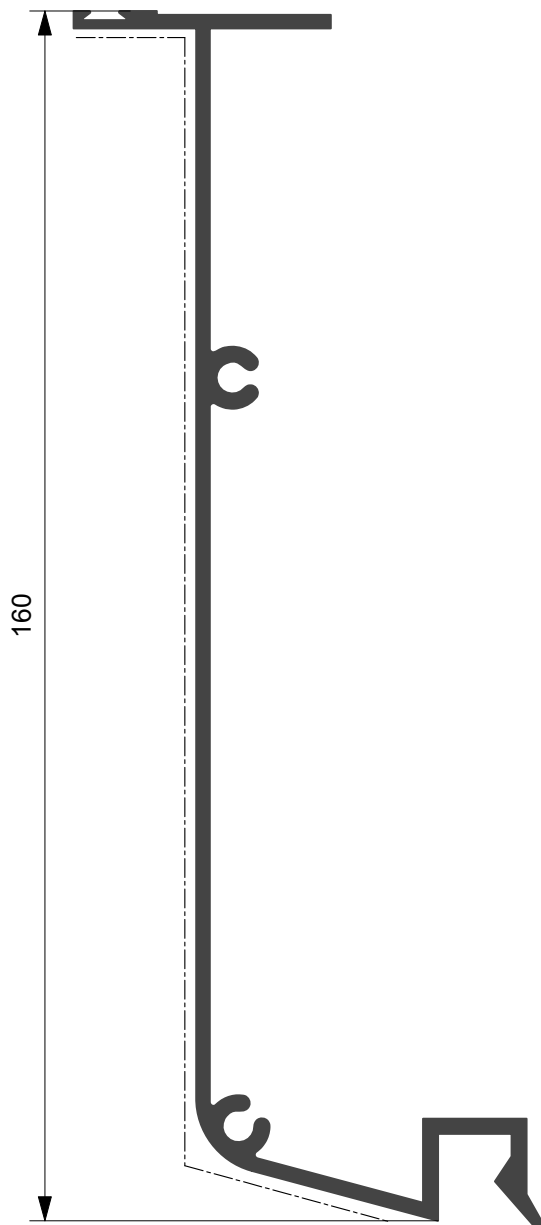

**CX45.3363**

Kg/ml 1.379  
--- mm. 182,0

**CX45.3362**

Kg/ml 1.150  
--- mm. 212,0

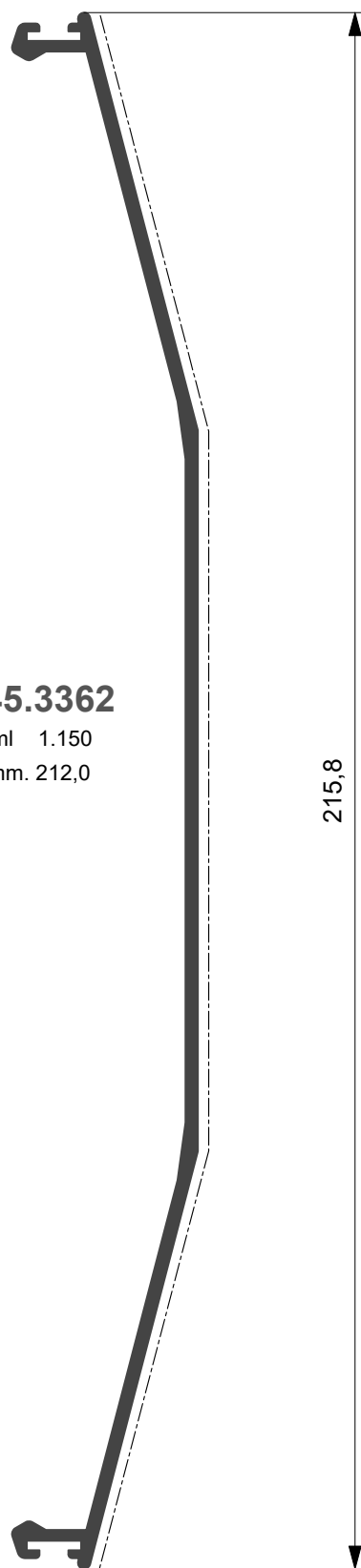

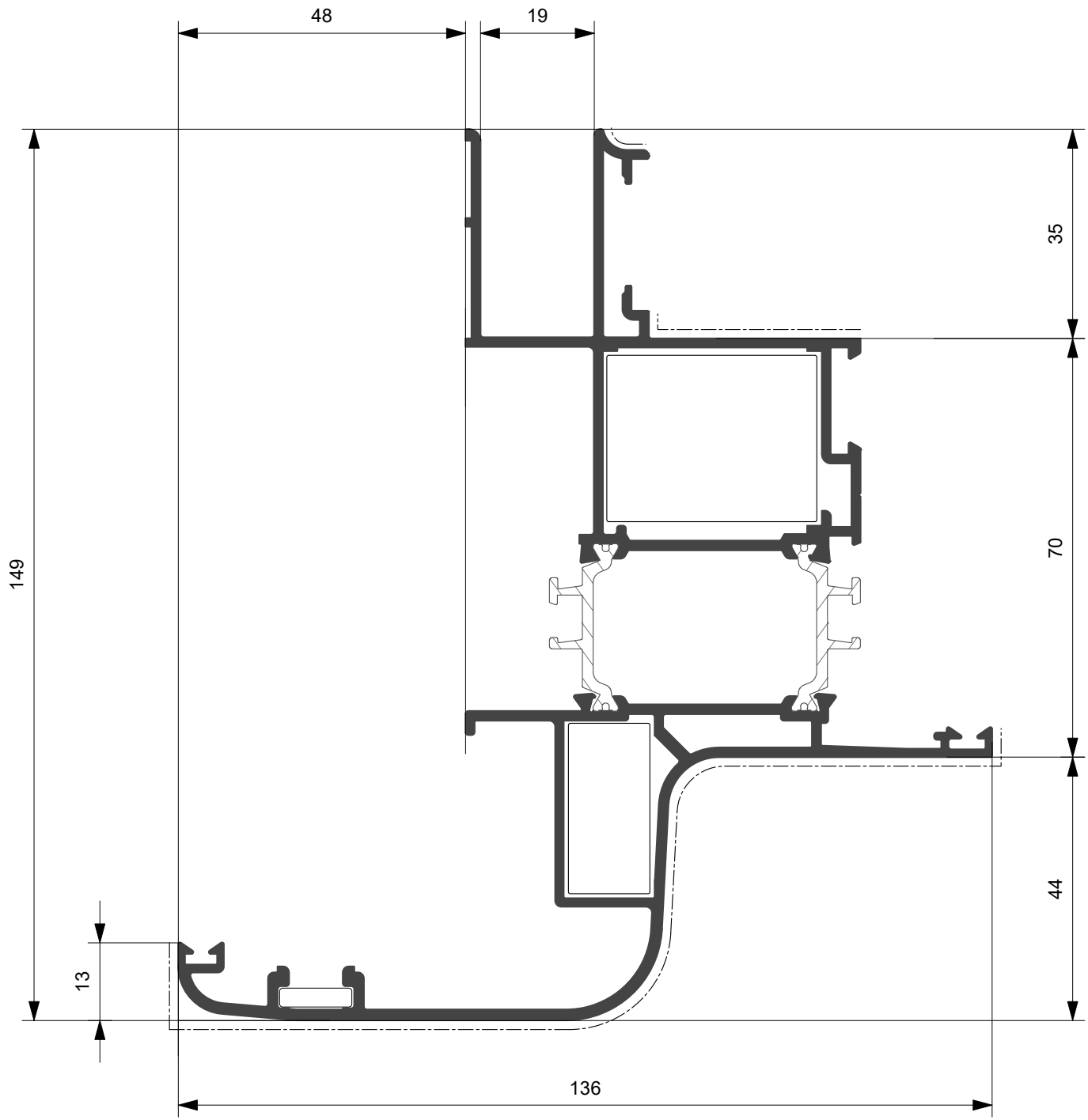

**CX70.109**  
Kg/ml 3.013  
--- mm. 242,0

Profilato	Squadretta esterna		Squadretta interna			Squadretta allineamento	
	Cianfrinare	Spinare	Bottone	Cianfrinare	Spinare	Esterna	Interna
CX70.109	ARX.01.SQ	ARX.02.SQ + ARX.07.SQ	ACX.04.SQ			ARX.15.SQ	ARX.10.SQ



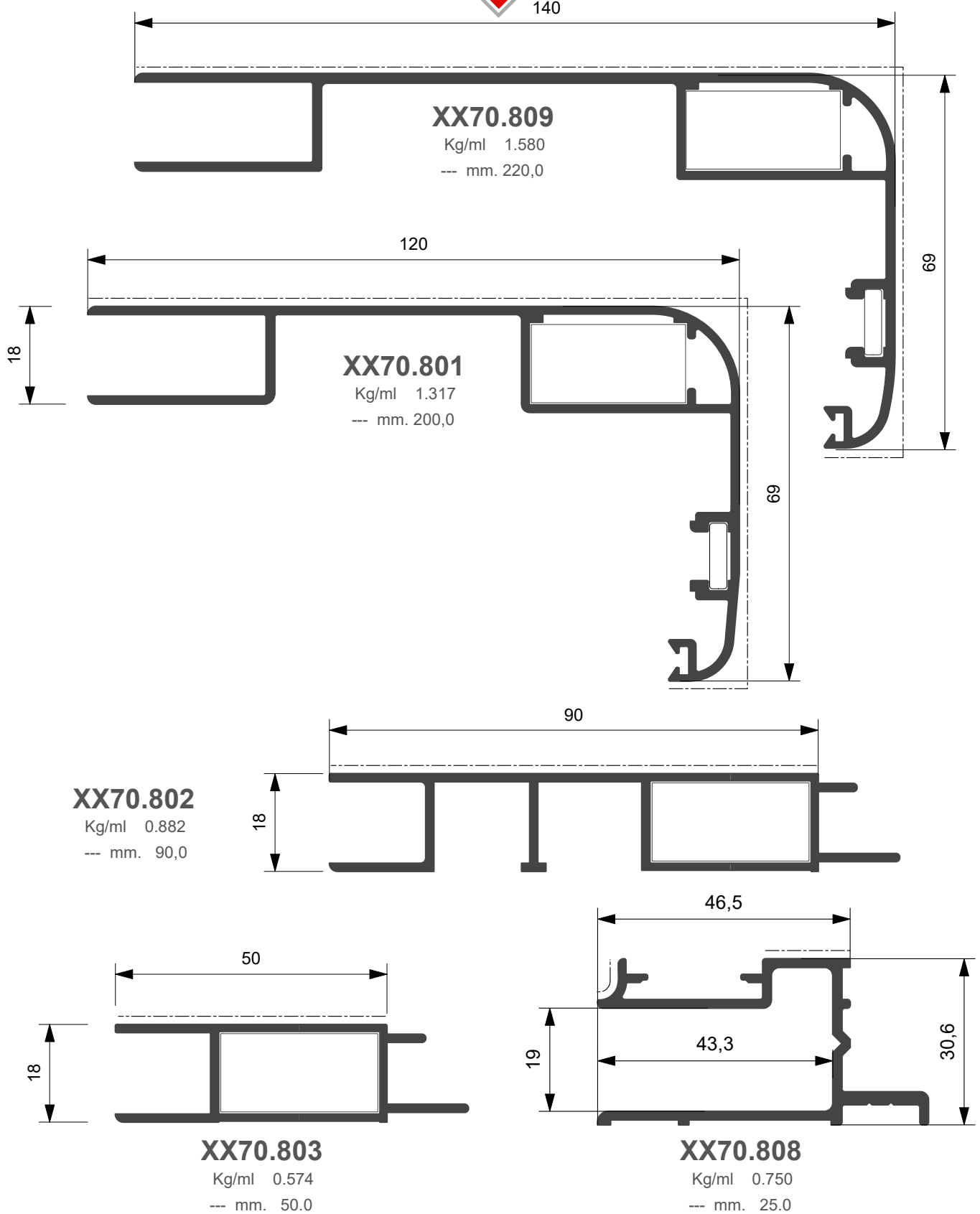

Profilato	Squadretta esterna		Squadretta interna			Squadretta allineamento	
	Bottone	Spinare	Bottone	Cianfrinare	Spinare	Esterna	Interna
XX70.801			ACX.01.SQ	ACX.02.SQ	ACX.02.SQ + ARX.07.SQ		ARX.11.SQ
XX70.802			ACX.01.SQ	ACX.02.SQ	ACX.02.SQ + ARX.07.SQ		
XX70.803			ACX.01.SQ	ACX.02.SQ	ACX.02.SQ + ARX.07.SQ		
XX70.809			ACX.01.SQ	ACX.02.SQ	ACX.02.SQ + ARX.07.SQ		ARX.11.SQ

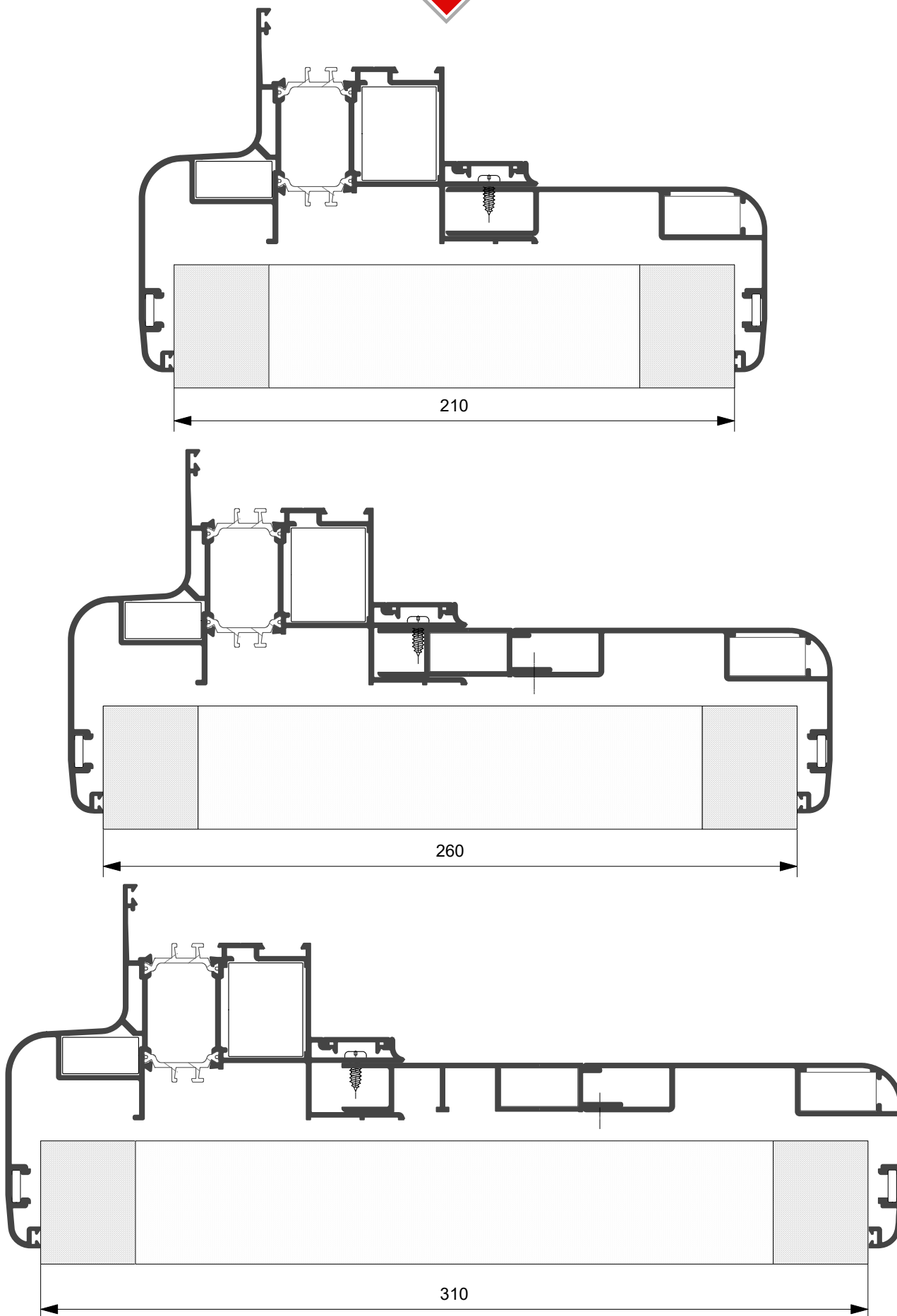



**CX70.540**

Kg/ml 0.2249  
--- mm. 32,0

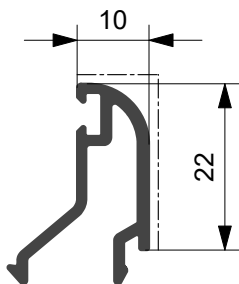

**CX70.521**

Kg/ml 0.266  
--- mm. 36,0

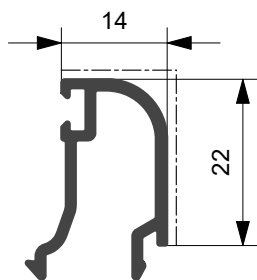

**CX70.522**

Kg/ml 0.277  
--- mm. 40,0

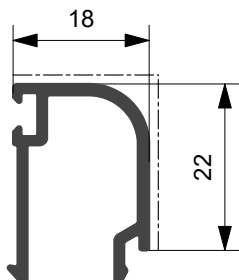

**CX70.523**

Kg/ml 0.294  
--- mm. 44,0

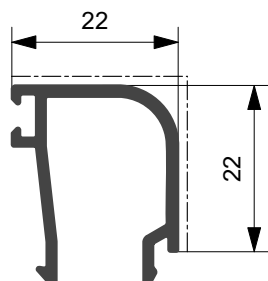

**CX70.524**

Kg/ml 0.314  
--- mm. 48,0

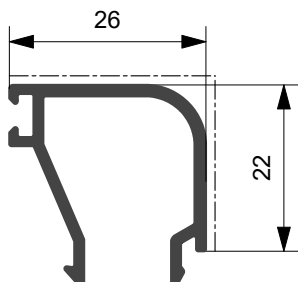

**CX70.525**

Kg/ml 0.350  
--- mm. 52,0

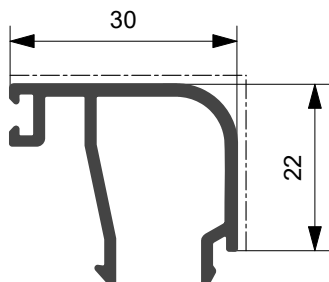

**APPLICAZIONE FERMAVETRI  
TONDI**

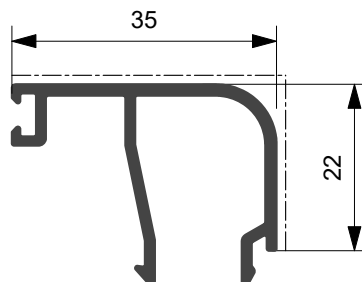
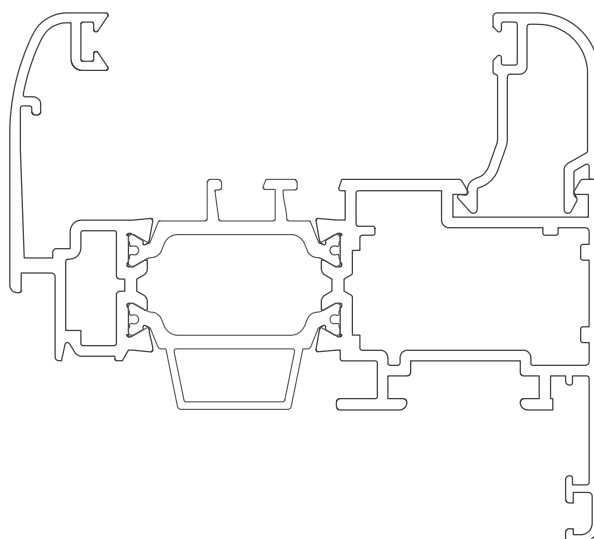

**CX70.531**

Kg/ml 0.370  
--- mm. 57,0



**CX70.533**

Kg/ml 0.252  
--- mm. 27,0

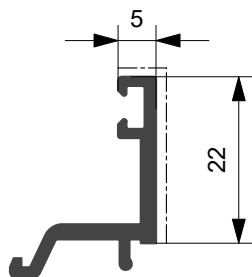

**APPLICAZIONE FERMAVETRI  
DRITTI**

**CX70.539**

Kg/ml 0.245  
--- mm. 27,0

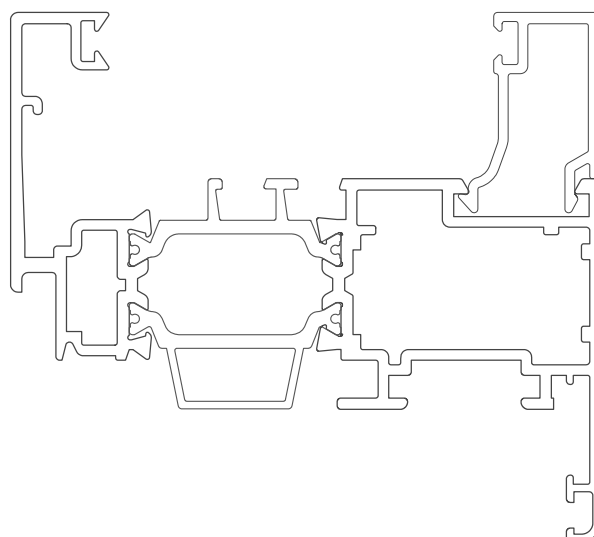
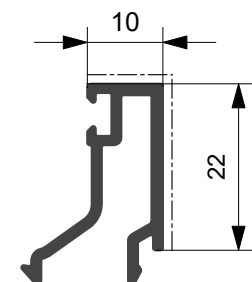

**CX70.526**

Kg/ml 0.279  
--- mm. 36,0

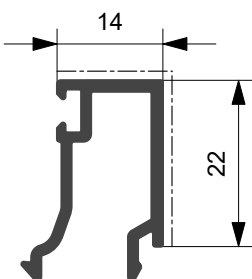

**CX70.527**

Kg/ml 0.290  
--- mm. 40,0

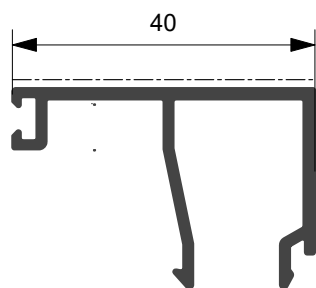
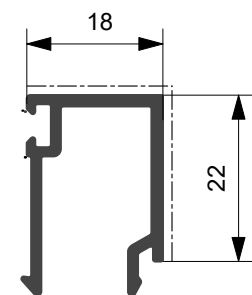

**CX70.537**

Kg/ml 0.403  
--- mm. 62,0

**CX70.528**

Kg/ml 0.307  
--- mm. 44,0

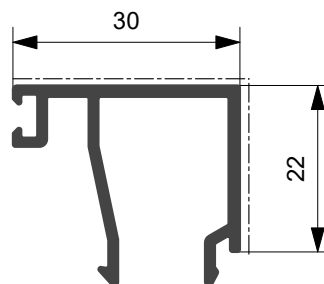
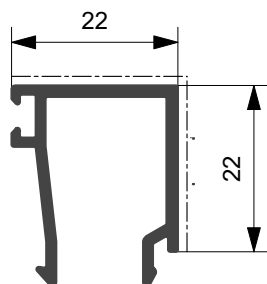

**CX70.530**

Kg/ml 0.362  
--- mm. 52,0

**CX70.529**

Kg/ml 0.327  
--- mm. 48,0

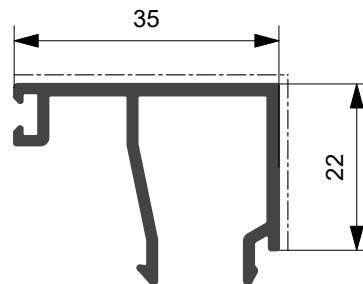
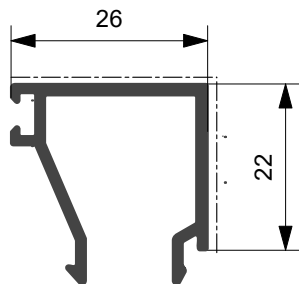

**CX70.532**

Kg/ml 0.383  
--- mm. 57,0



**CX70.571**

Kg/ml 0.216  
--- mm. 36,0

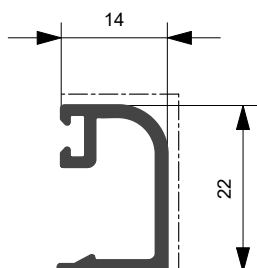

**CX70.572**

Kg/ml 0.262  
--- mm. 40,0

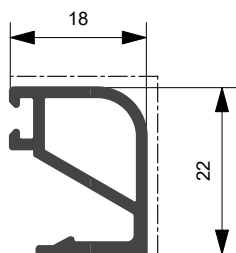

**CX70.573**

Kg/ml 0.283  
--- mm. 44,0

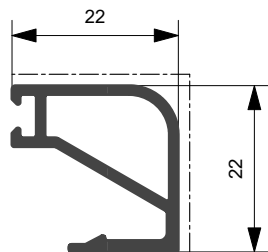

**CX70.574**

Kg/ml 0.313  
--- mm. 48,0

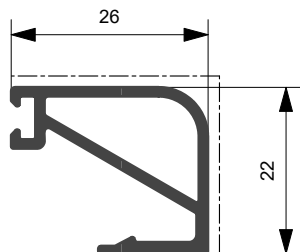

**CX70.575**

Kg/ml 0.340  
--- mm. 52,0

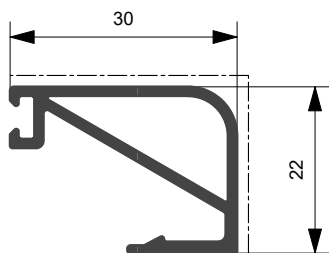

**RX70.581**

Kg/ml 0.361  
--- mm. 57,0

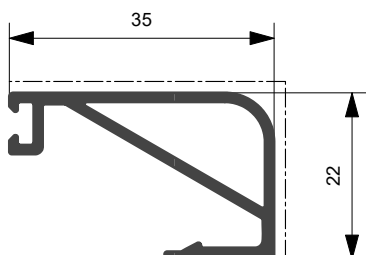

**APPLICAZIONE FERMAVETRI CON CLIPS**

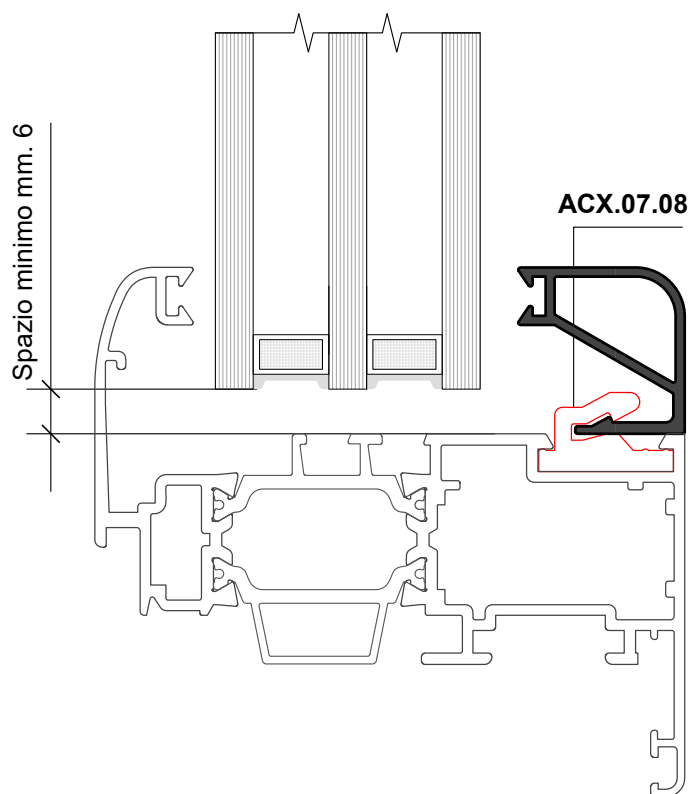

E' consigliabile l'abbinamento con fermavetri tradizionali tondi con taglio a 45°, al fine di evitare gli angoli fermavetro in zama



**CX70.568**

Kg/ml 0.297  
--- mm. 32,0

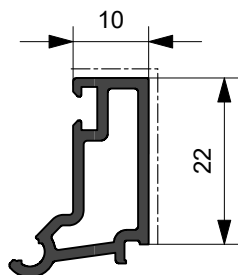

**CX70.562**

Kg/ml 0.324  
--- mm. 36,0

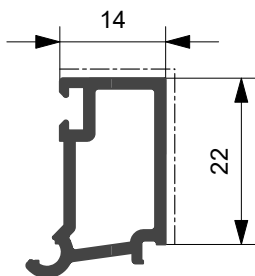

**CX70.563**

Kg/ml 0.330  
--- mm. 40,0

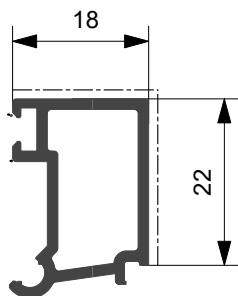

**CX70.564**

Kg/ml 0.348  
--- mm. 44,0

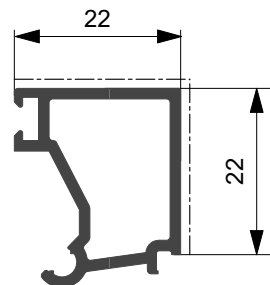

**CX70.565**

Kg/ml 0.372  
--- mm. 48,0

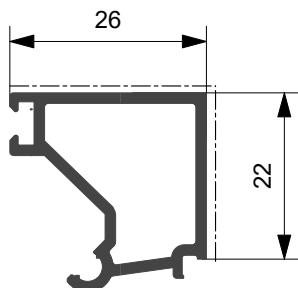

**CX70.566**

Kg/ml 0.396  
--- mm. 52,0

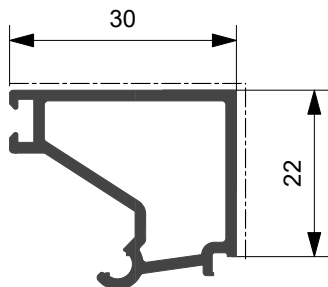

**APPLICAZIONE FERMAVETRI  
DI SICUREZZA**

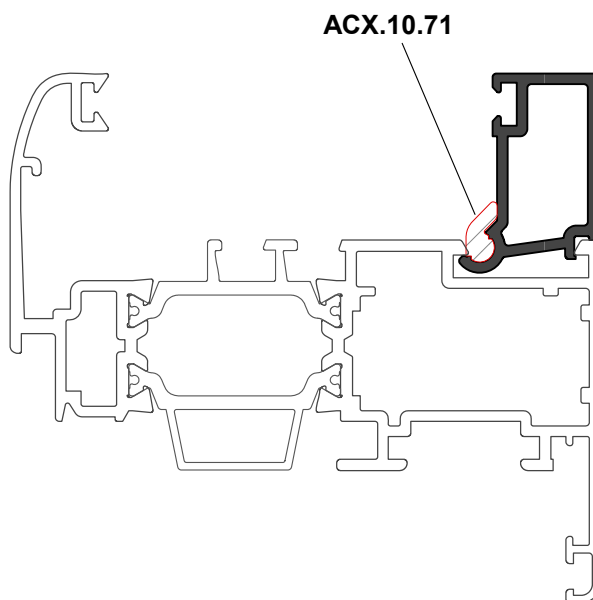

ACX.10.71

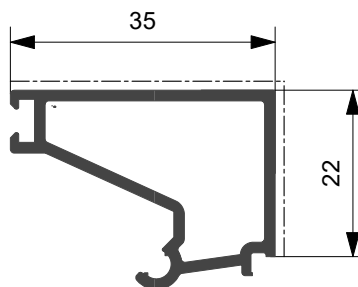

**CX70.567**

Kg/ml 0.434  
--- mm. 57,0

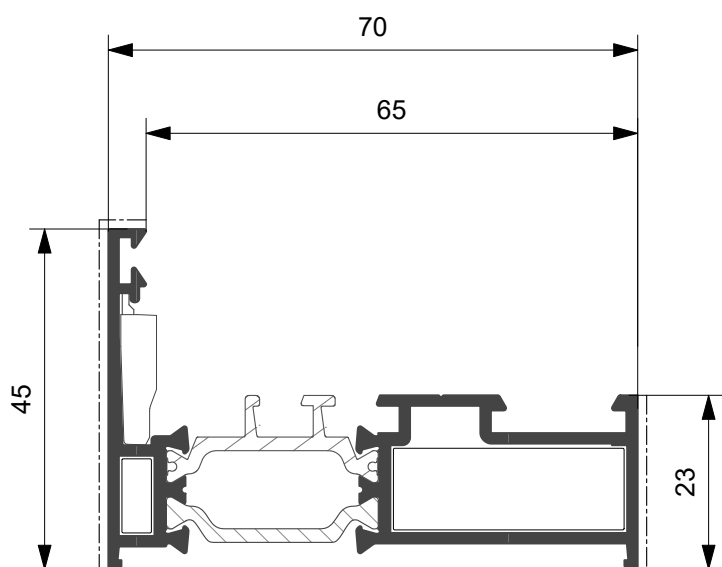

**CX70S.101**

Kg/ml 1,067  
--- mm. 73

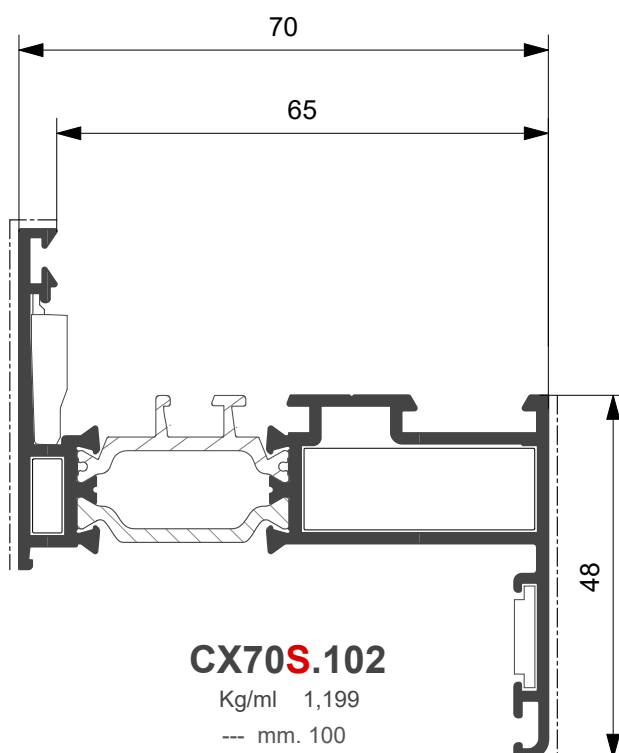

**CX70S.102**

Kg/ml 1,199  
--- mm. 100

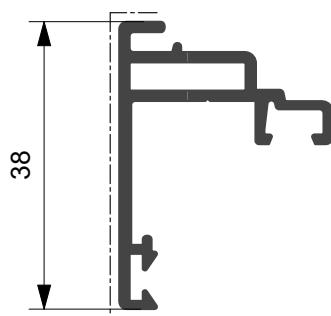

**CX60S.304**

Kg/ml 0.427  
--- mm. 48

Profilato	Squadretta esterna		Squadretta interna			Squadretta allineamento	
	Cianfrinare	Con grano fissaggio	Bottone	Cianfrinare	Spinare	Esterna	Interna
CX70S.101	ACX.36.SQ	ACX.36.SQ + GRLM4x5ECP	ACX.35.SQ			ARX.15.SQ	
CX70S.102	ACX.36.SQ	ACX.36.SQ + GRLM4x5ECP	ACX.35.SQ			ARX.15.SQ	ARX.10.SQ

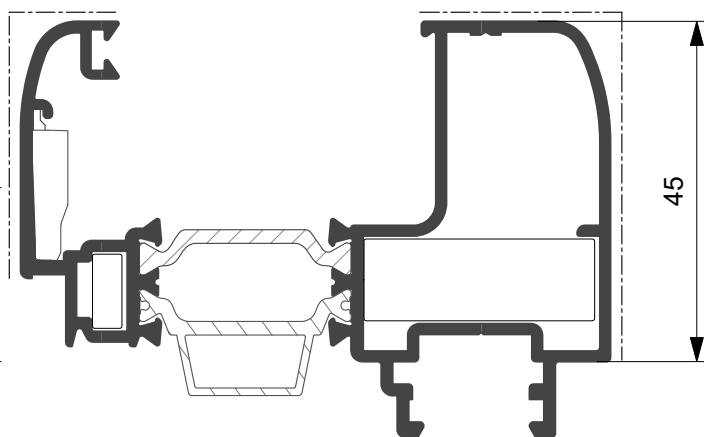
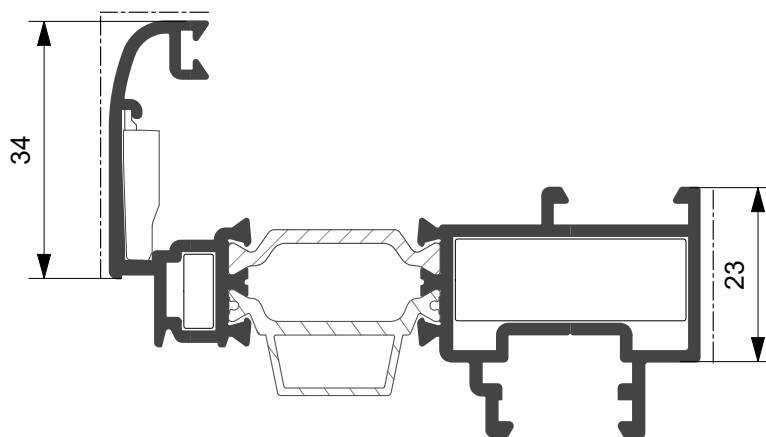
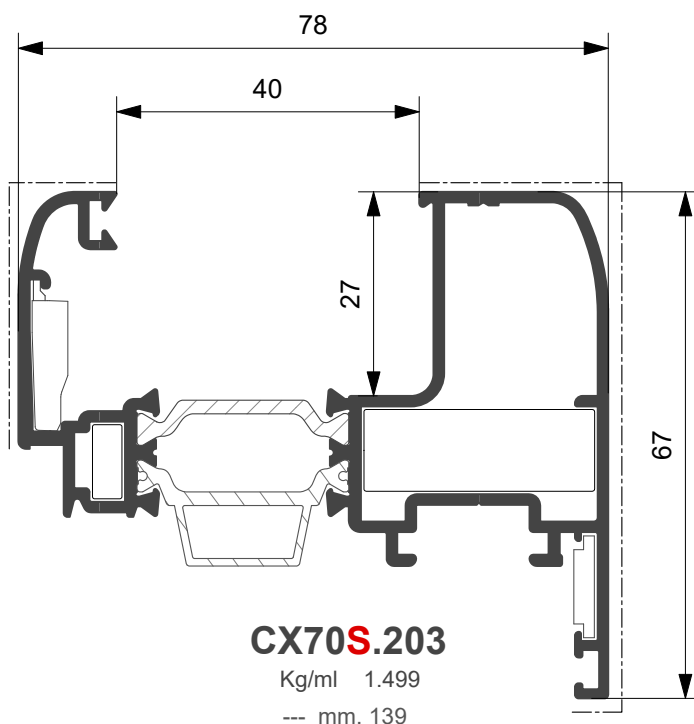
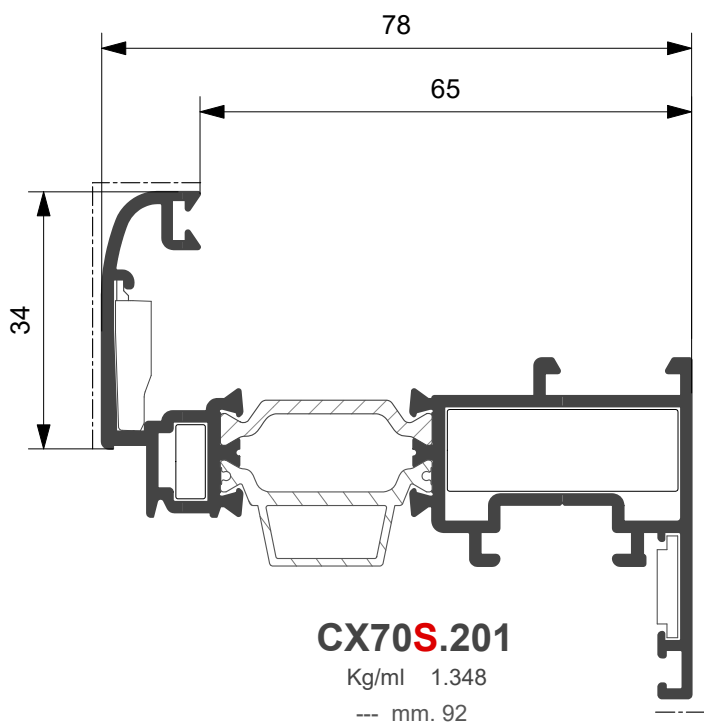

Profilato	Squadretta esterna		Squadretta interna			Squadretta allineamento	
	Cianfrinare	Con grano fissaggio	Bottone	Cianfrinare	Spinare	Esterna	Interna
CX70S.201	ACX.36.SQ	ACX.36.SQ + GRLM4x5ECP	ACX.35.SQ			ARX.15.SQ	ARX.10.SQ
CX70S.201R	ACX.36.SQ	ACX.36.SQ + GRLM4x5ECP	ACX.35.SQ			ARX.15.SQ	
CX70S.203	ACX.36.SQ	ACX.36.SQ + GRLM4x5ECP	ACX.35.SQ			ARX.15.SQ	ARX.10.SQ
CX70S.203R	ACX.36.SQ	ACX.36.SQ + GRLM4x5ECP	ACX.35.SQ			ARX.15.SQ	





Aletta <b>(a)</b> mm.	Vuoto <b>(v)</b> mm.	Dimensione fermavetro <b>(f)</b> mm.	Codice Fermavetro  D = dritto T = tondo	Guarnizione esterna  mm.	Guarnizioni interne vetro							
					ARX.10.15		ARX.10.14		ARX.10.13		ARX.10.12	
					mm.10	mm.9	mm.8	mm.7	mm.6	mm.5	mm.4	mm.3
Vetragezione ( spessore vetro in mm.)												
5	30	<b>35</b>	D <b>CX70.532</b> T <b>CX70.531</b>	3	17	18	19	20	21	22	23	24
5	35	<b>30</b>	D <b>CX70.530</b> T <b>CX70.525</b>	3	22	23	24	25	26	27	28	29
5	39	<b>26</b>	D <b>CX70.529</b> T <b>CX70.524</b>	3	26	27	28	29	30	31	32	33
5	43	<b>22</b>	D <b>CX70.528</b> T <b>CX70.523</b>	3	30	31	32	33	34	35	36	37
5	46	<b>18</b>	D <b>CX70.527</b> T <b>CX70.522</b>	3	34	35	36	37	38	39	40	41
5	51	<b>14</b>	D <b>CX70.526</b> T <b>CX70.521</b>	3	38	39	40	41	42	43	44	45
5	60	<b>5</b>	D <b>CX70.533</b>	3	47	48	49	50	51	52	53	54

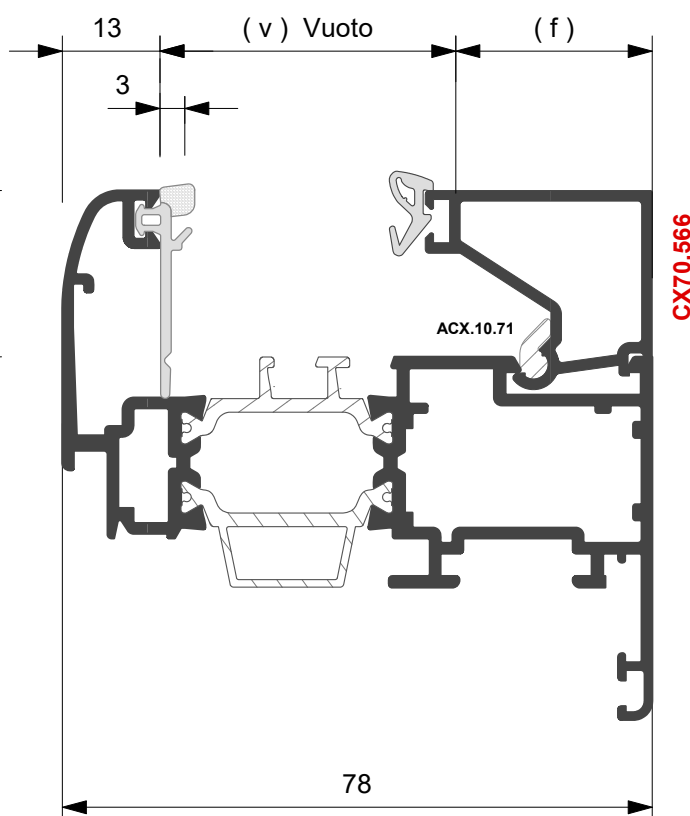
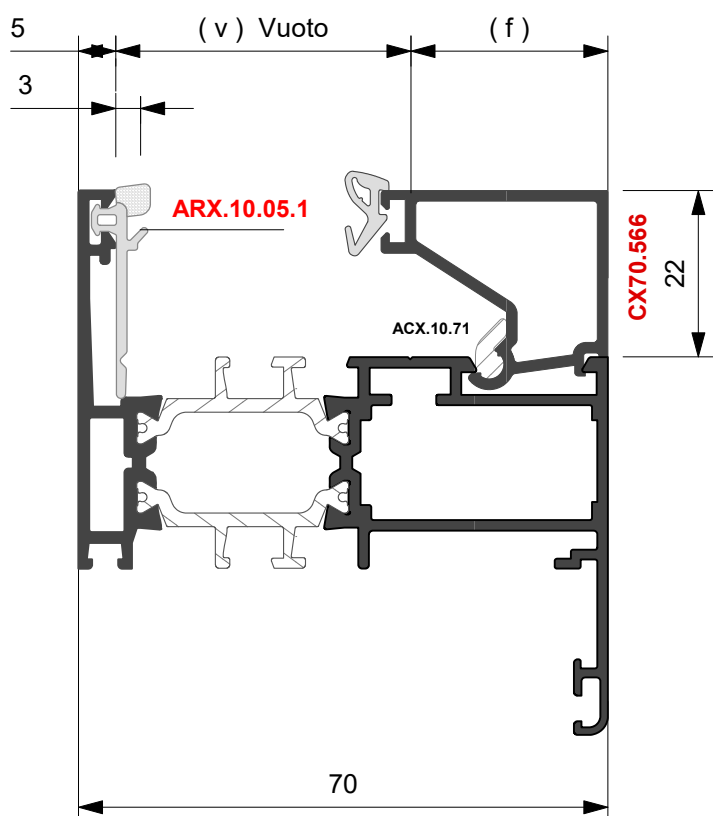



APPLICAZIONE TASSELLI VETRO PER TIPOLOGIA

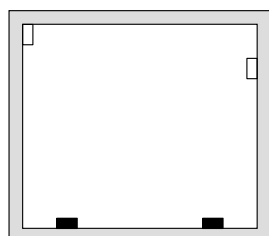

Telaio fisso

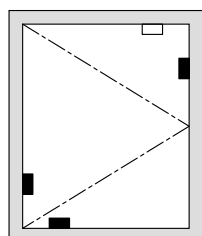

Anta a battente

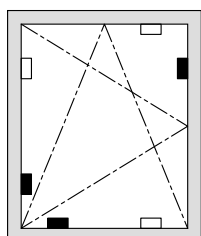

Anta ribalta

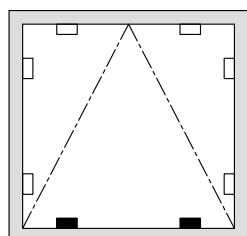
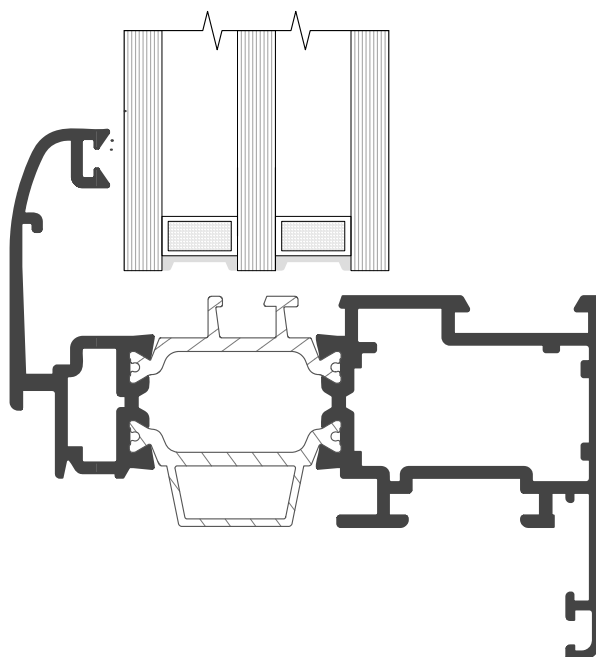

Wasistas

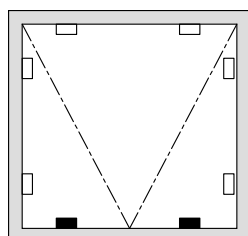

Sporgere

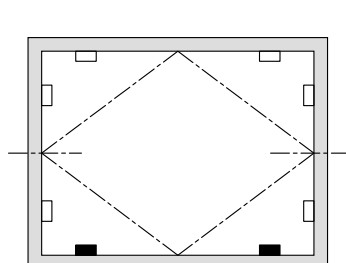

Bilico orizzontale

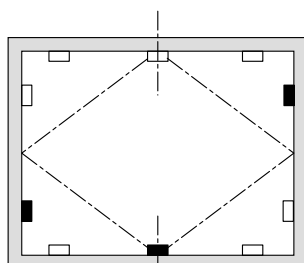

Bilico verticale

 Tassello di appoggio

 Tassello perimetrale





## Codifica finiture superficiali accessori



















In fase di ordine aggiungere agli accessori di seguito riportati, ove previste, le seguenti codifiche superficiali :

<b>SIGLA</b>	<b>DESCRIZIONE</b>
<b>NEOPA</b>	VERNICIATO NERO OPACO
<b>R9010</b>	VERNICIATO BIANCO
<b>R1013</b>	VERNICIATO AVORIO
<b>R6005</b>	VERNICIATO VERDE
<b>R9005</b>	VERNICIATO NERO LUCIDO
<b>R8017</b>	VERNICIATO MARRONE
<b>G6360</b>	VERNICIATO VERDE GOTICO
<b>G9420</b>	VERNICIATO GRIGIO GOTICO
<b>G3976</b>	VERNICIATO MARRONE GOTICO
<b>VEARG</b>	VERNICIATO ARGENTO
<b>VSCRA</b>	VERDE SCURO RAGGRINZITO
<b>MARAG</b>	MARRONE RAGGRINZITO
<b>KANFU</b>	CANNA DI FUCILE GOLDFINISH
<b>KRAME</b>	RAME GOLDFINISH
<b>KINOX</b>	INOX LUCIDO GOLDFINISH
<b>KSATI</b>	INOX SATINATO GOLDFINISH
<b>KGOLD</b>	GOLD GOLDFINISH
<b>KANTIC</b>	OTTONE ANTICO GOLDFINISH
<b>ARGENT</b>	NEW ARGENTO
<b>BRONZ</b>	NEW BRONZO

### Esempio :

**ACX.02.01 - R9010** Cerniera verniciata bianco Ral 9010



<b>ACX.01.SQ</b> Descrizione <b>Squadretta a pulsante</b> (28.5 mm x 14.5 mm)		<b>ACX.12.SQ</b> Descrizione <b>Cavallotto</b> (28.5 mm x 14.5 mm)	
<b>ACX.02.SQ</b> Descrizione <b>Squad. cianfrinare/spinare/avvit.</b> (28.5 mm x 14.5 mm)		<b>ARX.13.SQ</b> Descrizione <b>Squadretta a pulsante</b> (23.5 mm x 14.5 mm)	
<b>ARX.03.SQ</b> Descrizione <b>Squadretta cianfrinare/spinare</b> (4.3 mm x 14 mm)		<b>ACX.14.SQ</b> Descrizione <b>Squad. cianfrinare/spinare/avvit.</b> (28.5 mm x 35.8 mm)	
<b>ACX.04.SQ</b> Descrizione <b>Squadretta a pulsante</b> (28.5 mm x 35.8 mm)	 dx - sx	<b>ARX.15.SQ</b> Descrizione <b>Squadretta allineamento esterna tiraggio meccanico</b>	
<b>ACX.05.SQ</b> Descrizione <b>Squadretta angolo variabile</b> (28.5 mm x 14.5 mm)	 dx - sx	<b>ARX.18.SQ</b> Descrizione <b>Squadretta cianfrinare/spinare</b> (4.3 mm x 26.3 mm)	
<b>ARX.06.SQ</b> Descrizione <b>Squadretta cianfrinare/spinare</b> (4.3 mm x 39.1 mm)		<b>ARX.24.SQ</b> Descrizione <b>Squad. allineamento esterna</b>	
<b>ARX.08.SQ</b> Descrizione <b>Spina per squadretta ACX.3.SQ e ACX.6.SQ</b>		<b>ACX.29.SQ</b> Descrizione <b>Cavallotto e vite</b> (Prof. CX70.402)	
<b>ARX.10.SQ</b> Descrizione <b>Squadretta allineamento interna</b>		<b>ARX.34.SQ</b> Descrizione <b>Squadretta per profilo scuretto RX450.427</b>	
<b>ARX.11.SQ</b> Descrizione <b>Squadretta allineamento interna su profilo XX70.801 e RX60.109</b>		<b>ASX.24.SQ</b> Descrizione <b>Squadretta a pulsante</b> (31.8 mm x 10.4 mm)	



**Cerniere**

<p><b>ACX.35.SQ</b></p> <p>Descrizione</p> <p>Squadretta a pulsante</p>	 <p>SLIM</p>	<p><b>ACX.02.08</b></p> <p>Descrizione</p> <p>Braccio corto per vasistas (anta da mm. 280 a mm. 800)</p>	
<p><b>ACX.36.SQ</b></p> <p>Descrizione</p> <p>Squadretta est. cianfrinare o con grano GRLM4x5ECP da ordinare a parte</p>	 <p>SLIM</p>	<p><b>ACX.02.09</b></p> <p>Descrizione</p> <p>Braccio telescopico per vasistas a scatto</p>	
<p><b>ACX.02.01</b></p> <p>Descrizione</p> <p>Cerniera a montaggio rapido preassemblata a 2 ali</p>		<p><b>ACX.02.10</b></p> <p>Descrizione</p> <p>Cerniera a compasso</p>	
<p><b>ACX.02.02</b></p> <p>Descrizione</p> <p>Cerniera a montaggio rapido preassemblata a 2 ali per 3°anta</p>		<p><b>ACX.02.10P</b></p> <p>Descrizione</p> <p>Cerniera cerniera scomparsa battente 40 kg, sporgere 120 kg, vasistat 120 kg</p>	
<p><b>ACX.02.03</b></p> <p>Descrizione</p> <p>Cerniera a montaggio rapido preassemblata a 3 ali</p>		<p><b>ACX.02.11</b></p> <p>Descrizione</p> <p>Cerniera a 2 ali per porte con piastrina ad infilare</p>	
<p><b>ACX.02.04</b></p> <p>Descrizione</p> <p>Cerniera a montaggio rapido preassemblata a 3 ali per 3°anta</p>		<p><b>ARX.02.12</b></p> <p>Descrizione</p> <p>Cerniera per porte esterna a 2 ali interasse 67 mm.</p>	
<p><b>ACX.02.05</b></p> <p>Descrizione</p> <p>Cerniera per vasistas apertura singola 30°</p>		<p><b>ARX.02.13</b></p> <p>Descrizione</p> <p>Cerniera per porte esterna a 3 ali interasse 67 mm.</p>	
<p><b>ACX.02.06</b></p> <p>Descrizione</p> <p>Cerniera per vasistas apertura doppia 30°/75°</p>		<p><b>ARX.02.14</b></p> <p>Descrizione</p> <p>Cerniera per porte esterna a 2 ali interasse 93 mm.</p>	
<p><b>ACX.02.07</b></p> <p>Descrizione</p> <p>Braccio lungo per vasistas (anta da mm. 600 a mm. 1600)</p>		<p><b>ARX.02.15</b></p> <p>Descrizione</p> <p>Cerniera per porte esterna a 3 ali interasse 93 mm.</p>	



<b>ARX.02.16</b> Descrizione Spessore mm.8 per cerniere esterne per porte		<b>ACX.02.41</b> Descrizione Cerniera montaggio rapido "TOP RAPID"	SLIM
<b>ARX.02.17</b> Descrizione Cerniera per scuretto		<b>ACX.03.01</b> Descrizione Cricchetto in alluminio fissaggio con piastrine	
<b>ARX.02.21</b> Descrizione Kit contropiastre cerniere a 2 ali		<b>ARX.03.02</b> Descrizione Maniglia a tavellino	
<b>ARX.02.22</b> Descrizione Kit contropiastre cerniere a 3 ali		<b>ARX.03.03</b> Descrizione Maniglia doppia	
<b>ARX.02.23</b> Descrizione Parni fissaggio cerniere da 68 mm.		<b>ASX.03.03</b> Descrizione Martellina doppia COMFORT	
<b>ARX.02.24</b> Descrizione Viti di fissaggio cerniere		<b>ARX.03.04</b> Descrizione Martellina Sporgenza quadro mm.24	
<b>ARX.02.25</b> Descrizione Kit gradino		<b>ARX.03.05</b> Descrizione Martellina con chiave Sporgenza quadro mm.24	
<b>ARX.02.37</b> Descrizione Regolatore in altezza per cerniere ARX.02.11		<b>ARX.03.05LDX</b> Descrizione Martellina LOGICA dx Sporgenza quadro mm.24	
<b>ACX.02.40</b> Descrizione Cerniera montaggio rapido "TOP RAPID"	SLIM	<b>ARX.03.05LSX</b> Descrizione Martellina LOGICA sx Sporgenza quadro mm.24	











<p><b>ARX.03.06</b></p> <p>Descrizione</p> <p>Cremonese Interasse 84 - 92 - 104</p>		<p><b>ACX.03.14</b></p> <p>Descrizione</p> <p>Incontro asta doppio</p>		
<p><b>ARX.03.07</b></p> <p>Descrizione</p> <p>Cremonese con chiave Interasse 84 - 92 - 104</p>		<p><b>ACX.03.15</b></p> <p>Descrizione</p> <p>Ferma anta</p>		
<p><b>ARX.03.07LDX</b></p> <p>Descrizione</p> <p>Cremonese LOGICA dx Interasse 84 - 92 - 104</p>		<p><b>ACX.03.16</b></p> <p>Descrizione</p> <p>Perno di chiusura supplementare regolabile</p>		
<p><b>ARX.03.07LSX</b></p> <p>Descrizione</p> <p>Cremonese LOGICA sx Interasse 84 - 92 - 104</p>		<p><b>ACX.03.17</b></p> <p>Descrizione</p> <p>Innesti cremonese</p>		
<p><b>ARX.03.08</b></p> <p>Descrizione</p> <p>Cremonese per Anta Ribalta</p>		<p><b>ACX.03.18</b></p> <p>Descrizione</p> <p>Terminali astina</p>		
<p><b>ARX.03.09</b></p> <p>Descrizione</p> <p>Movimentazione Bidirezionale Interasse da 15-27 mm.</p>		<p><b>ACX.03.19</b></p> <p>Descrizione</p> <p>Sostegno anta</p>		
<p><b>ACX.03.10</b></p> <p>Descrizione</p> <p>Movimentazione Unidirezionale per Anta Ribalta</p>		<p><b>ARX.03.22</b></p> <p>Descrizione</p> <p>Fast Out chiusura apert. esterna L=1000 mm.(3 punti ) E = 35mm.</p>		
<p><b>ACX.03.11</b></p> <p>Descrizione</p> <p>Catenacciolo a leva</p>				<p><b>ARX.03.23</b></p> <p>Descrizione</p> <p>Fast Out chiusura apert. esterna L=600 mm.(2 punti ) E = 35mm.</p>
<p><b>ACX.03.12</b></p> <p>Descrizione</p> <p>Terminale asta</p>				<p><b>ARX.03.24</b></p> <p>Descrizione</p> <p>Fast Out chiusura apert. esterna L=1600 mm.(3 punti ) E = 35mm.</p>







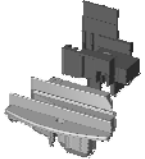

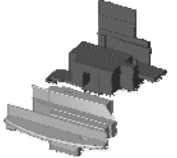





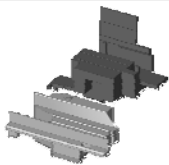

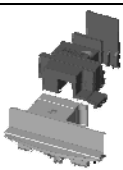

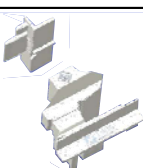

<p><b>ACX.03.25</b></p> <p>Descrizione</p> <p>Kit Fast Out chiusura apert. esterna art. ARX.03.22</p>		<p><b>ARX.03.48</b></p> <p>Descrizione</p> <p>Cremonese apertura esterna con chiave</p>	
<p><b>ACX.03.26</b></p> <p>Descrizione</p> <p>Kit Fast Out chiusura apert. esterna art. ACX.03.23</p>		<p><b>ARX.03.50</b></p> <p>Descrizione</p> <p>Cremonese apertura esterna con chiave</p>	
<p><b>ACX.03.27</b></p> <p>Descrizione</p> <p>Kit Fast Out chiusura apert. esterna art. ACX.03.24</p>		<p><b>ACX.03.52</b></p> <p>Descrizione</p> <p>Braccio chiusura antieffrazione</p>	
<p><b>ARX.03.28</b></p> <p>Descrizione</p> <p>Martellina Sporgenza quadro mm.64 per Fast Out</p>		<p><b>ACX.03.53</b></p> <p>Descrizione</p> <p>Martellina Italia Sporgenza quadro 24 mm, con scatto per microventilazione</p>	
<p><b>ACX.03.29</b></p> <p>Descrizione</p> <p>Rostro chiusura supplementare</p>		<p><b>ACX.03.54</b></p> <p>Descrizione</p> <p>Sirio terminale asta con puntale in ottone ø 6 mm, decentrato dx</p>	
<p><b>ARX.03.30</b></p> <p>Descrizione</p> <p>Tavellino per profilo scuretto RX450.427</p>		<p><b>ACX.03.55</b></p> <p>Descrizione</p> <p>Sirio terminale asta con puntale in ottone ø 6 mm, decentrato sx</p>	
<p><b>ACX.03.43</b></p> <p>Descrizione</p> <p>Astina in poliammide</p>		<p><b>ACX.03.56</b></p> <p>Descrizione</p> <p>Sirio terminale asta con puntale in ottone ø 8 mm</p>	
<p><b>ARX.03.45</b></p> <p>Descrizione</p> <p>Perno trascinamento L=22 mm.</p>		<p><b>ACX.03.57</b></p> <p>Descrizione</p> <p>Cremonese ITALIA int. 84,5 - 104 mm.</p>	
<p><b>ARX.03.46</b></p> <p>Descrizione</p> <p>Cremonese con chiave</p>		<p><b>ACX.03.58</b></p> <p>Descrizione</p> <p>Kit base accessori per chiusura antieffrazione</p>	



<p><b>ACX.03.59</b></p> <p>Descrizione <b>Cremonese ITALIA</b> per AR con anti falsa manovra su cremonese</p>		<p><b>ACX.03.68</b></p> <p>Descrizione <b>Doppia maniglia</b> "Comfort mini"</p>	
<p><b>ACX.03.60</b></p> <p>Descrizione <b>Punto chiusura antieffrazione</b> lavorazione astina tonda diam. 8</p>		<p><b>ACX.03.69</b></p> <p>Descrizione <b>Doppia maniglia</b> "ITALIA"</p>	
<p><b>ACX.03.61</b></p> <p>Descrizione <b>Chiusura antieffrazione</b> sistema di sicurezza per connessione astina</p>		<p><b>ACX.03.70</b></p> <p>Descrizione <b>Catenaccio a comando diretto</b> Sirio</p>	
<p><b>ACX.03.62</b></p> <p>Descrizione <b>Incontro a pozzetto</b> per puntale ø 6 mm</p>		<p><b>ACX.03.71</b></p> <p>Descrizione <b>Catenaccio a leva</b> "Mini tex"</p>	 <p style="color: red;">SLIM</p>
<p><b>ACX.03.63</b></p> <p>Descrizione <b>Incontro a pozzetto</b> per puntale ø 6 mm</p>		<p><b>ACX.03.72</b></p> <p>Descrizione <b>Movimentazione Bidirezionale</b> Interasse da 23-35 mm.</p>	
<p><b>ACX.03.64</b></p> <p>Descrizione <b>Corpo di manovra a leva</b> "Mini tex"</p>		<p><b>ACX.03.73</b></p> <p>Descrizione <b>"COMFORT MINI"</b> <b>Martellina ridotta</b> Sporgenza quadro mm.70</p>	
<p><b>ACX.03.65</b></p> <p>Descrizione <b>Catenaccio a leva</b> <b>bidirezionale</b> "bi-hid" kit</p>		<p><b>ACX.03.74</b></p> <p>Descrizione <b>"COMFORT MINI"</b> <b>Martellina ridotta con cilindro</b> Sporgenza quadro mm.70</p>	
<p><b>ACX.03.66</b></p> <p>Descrizione <b>Perno di trascinamento</b> L=11 mm</p>		<p><b>ACX.04.01HP</b></p> <p>Descrizione <b>Tappo riporto Giunto Aperto</b> Profilo riporto tondo</p>	
<p><b>ACX.03.67</b></p> <p>Descrizione <b>Perno di trascinamento</b> L=27 mm</p>		<p><b>ARX.04.02HP</b></p> <p>Descrizione <b>Tappo riporto G. A. ferr. nastro</b> Profilo riporto tondo</p>	

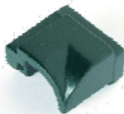



<p><b>ACX.04.03HP</b></p> <p>Descrizione</p> <p>Tappo riporto Giunto Aperto Profilo riporto dritto</p>		<p><b>ARX.06.02</b></p> <p>Descrizione</p> <p>Piastrina Registro Universale</p>	
<p><b>ARX.04.04HP</b></p> <p>Descrizione</p> <p>Tappo riporto G. A. ferr. nastro Profilo riporto dritto</p>		<p><b>ARX.06.03</b></p> <p>Descrizione</p> <p>Grano per registro ARX.06.02</p>	
<p><b>ACX.04.07</b></p> <p>Descrizione</p> <p>Tappo doppia battuta</p>		<p><b>ACX.06.04</b></p> <p>Descrizione</p> <p>Registro Z/P</p>	
<p><b>ACX.04.34</b></p> <p>Descrizione</p> <p>Tappo riporto T - Z</p>	 <p>SLIM</p>	<p><b>ARX.06.08</b></p> <p>Descrizione</p> <p>Regolo mobile da mm.15</p>	
<p><b>ARX.04.20</b></p> <p>Descrizione</p> <p>Giunto taglio a 90° vetro infilare</p>		<p><b>ARX.06.09</b></p> <p>Descrizione</p> <p>Regolo mobile da mm. 20</p>	
<p><b>ARX.04.30</b></p> <p>Descrizione</p> <p>Tappo a L battuta inferiore porte</p>		<p><b>ARX.06.10</b></p> <p>Descrizione</p> <p>Regolo mobile da mm. 30</p>	
<p><b>ARX.04.31</b></p> <p>Descrizione</p> <p>Tappo diritto battuta inf. porte</p>		<p><b>ARX.06.11</b></p> <p>Descrizione</p> <p>Regolo mobile da mm. 45</p>	
<p><b>ARX.05.01</b></p> <p>Descrizione</p> <p>Cappetta drenaggio acqua</p>		<p><b>ACX.07.02</b></p> <p>Descrizione</p> <p>Angolo Universale fermavetro</p>	
<p><b>ARX.06.01</b></p> <p>Descrizione</p> <p>Registro Universale</p>			











<p><b>ACX.08.01</b></p> <p>Descrizione</p> <p>Anta Ribalta WEEN Kit base con anti falsa manovra sulla cremonese portata 160 Kg.</p>		<p><b>ACX.08.16</b></p> <p>Descrizione</p> <p>Perno chiusura supplementare</p>	
<p><b>ARX.08.01L</b></p> <p>Descrizione</p> <p>Anta Ribalta WEEN Kit base con anti falsa manovra sulla cremonese portata 160 Kg.</p> <p><b>Logica</b></p>		<p><b>ACX.08.18</b></p> <p>Descrizione</p> <p>Chiusura supplementare inferiore orizzontale</p>	
<p><b>ACX.08.05</b></p> <p>Descrizione</p> <p>A. R. Braccio Supplementare</p>		<p><b>ACX.08.19</b></p> <p>Descrizione</p> <p>Dispositivo microventilazione regolabile</p>	
<p><b>ACX.08.05L</b></p> <p>Descrizione</p> <p>A. R. Braccio Supplementare</p> <p><b>Logica</b></p>		<p><b>ACX.08.22</b></p> <p>Descrizione</p> <p>Anta Ribalta Braccio Corto da 395 mm. a 450 mm.</p>	
<p><b>ACX.08.06</b></p> <p>Descrizione</p> <p>Chiusura Supplementare verticale e universale</p>		<p><b>ACX.08.22L</b></p> <p>Descrizione</p> <p>Anta Ribalta Braccio Corto da 395 mm. a 450 mm.</p> <p><b>Logica</b></p>	
<p><b>ACX.08.09</b></p> <p>Descrizione</p> <p>A. R. Cerniere a pettine 2.0</p>		<p><b>ACX.08.23</b></p> <p>Descrizione</p> <p>Anta Ribalta Braccio Medio da 451 mm. a 650 mm.</p>	
<p><b>ACX.08.13</b></p> <p>Descrizione</p> <p>Incontro asta singolo</p>		<p><b>ACX.08.23L</b></p> <p>Descrizione</p> <p>Anta Ribalta Braccio Medio da 451 mm. a 650 mm.</p> <p><b>Logica</b></p>	
<p><b>ACX.08.13</b></p> <p>Descrizione</p> <p>Incontro asta singolo</p>		<p><b>ACX.08.24</b></p> <p>Descrizione</p> <p>Anta Ribalta Braccio Lungo da 651 mm. a 1700 mm.</p>	
<p><b>ACX.08.13</b></p> <p>Descrizione</p> <p>Incontro asta singolo</p>		<p><b>ACX.08.24L</b></p> <p>Descrizione</p> <p>Anta Ribalta Braccio Lungo da 651 mm. a 1700 mm.</p> <p><b>Logica</b></p>	















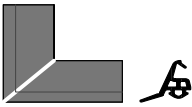







<p><b>ACX.08.25</b></p> <p>Descrizione Kit cerniera a pettine regol. Portata 120 Kg.</p>		<p><b>ACX.08.34</b></p> <p>Descrizione <b>Ween hide 180</b> braccio medio AR scomparsa - sx solo per ante CX70.260HP e CX70.261HP</p>	 <p><b>Logica</b></p>
<p><b>ACX.08.26</b></p> <p>Descrizione <b>Cerniere vasistas a scomparsa</b> solo per ante CX70.260HP e CX70.261HP</p>		<p><b>ACX.08.35</b></p> <p>Descrizione <b>Ween hide 180</b> supporto anta per portata 170 kg. ante CX70.260HP e CX70.261HP</p>	
<p><b>ACX.08.27</b></p> <p>Descrizione <b>Ween hide 180</b> braccio corto AR a scomparsa - dx solo per ante CX70.260HP e CX70.261HP</p>		<p><b>ACX.08.36</b></p> <p>Descrizione <b>Ween hide 180</b> cerniera superiore scomparsa - dx ante CX70.260HP e CX70.261HP</p>	
<p><b>ACX.08.28</b></p> <p>Descrizione <b>Ween hide 180</b> braccio corto AR a scomparsa - sx solo per ante CX70.260HP e CX70.261HP</p>		<p><b>ACX.08.37</b></p> <p>Descrizione <b>Ween hide 180</b> cerniera superiore scomparsa - sx ante CX70.260HP e CX70.261HP</p>	
<p><b>ACX.08.29</b></p> <p>Descrizione <b>Ween hide 180</b> braccio corto AR a scomparsa - dx solo per ante CX70.260HP e CX70.261HP</p>	 <p><b>Logica</b></p>	<p><b>ACX.08.38</b></p> <p>Descrizione <b>Ween hide 180</b> cerniera sup.a scomparsa per anta battente(dx) ante CX70.260HP e CX70.261HP</p>	
<p><b>ACX.08.30</b></p> <p>Descrizione <b>Ween hide 180</b> braccio corto AR a scomparsa - sx solo per ante CX70.260HP e CX70.261HP</p>	 <p><b>Logica</b></p>	<p><b>ACX.08.39</b></p> <p>Descrizione <b>Ween hide 180</b> cerniera sup.a scomparsa per anta battente(sx) ante CX70.260HP e CX70.261HP</p>	
<p><b>ACX.08.31</b></p> <p>Descrizione <b>Ween hide 180</b> braccio medio AR scomparsa - dx solo per ante CX70.260HP e CX70.261HP</p>		<p><b>ACX.08.40</b></p> <p>Descrizione <b>Ween hide 180</b> kit base anta ribalta con anti falsa manovra sulla cremonese ante CX70.260HP e CX70.261HP</p>	
<p><b>ACX.08.32</b></p> <p>Descrizione <b>Ween hide 180</b> braccio medio AR scomparsa - sx solo per ante CX70.260HP e CX70.261HP</p>		<p><b>ACX.08.41</b></p> <p>Descrizione <b>Ween hide 180</b> kit base anta ribalta con anti falsa manovra sulla cremonese ante CX70.260HP e CX70.261HP</p>	 <p><b>Logica</b></p>
<p><b>ACX.08.33</b></p> <p>Descrizione <b>Ween hide 180</b> braccio medio AR scomparsa - dx solo per ante CX70.260HP e CX70.261HP</p>	 <p><b>Logica</b></p>	<p><b>ACX.08.42</b></p> <p>Descrizione <b>Martellina ITALIA</b> sporgenza quadro 24 mm, con scatto microventilazione</p>	



<p><b>ACX.08.43</b></p> <p>Descrizione <b>Anta ribalta</b> <b>"ween wi-cloud ar"</b> automatica port.max 160 kg</p>		
<p><b>ACX.08.44</b></p> <p>Descrizione <b>Catenaccio a leva</b> ad appoggio per anta affiancata Ween</p>		
<p><b>ARX.09.01</b></p> <p>Descrizione <b>Attrezzatura Pneumatica</b></p>		
<p><b>ARX.09.02</b></p> <p>Descrizione <b>KIT FRESE</b></p>		
<p><b>ACX.20.01</b></p> <p>Descrizione <b>WI-CLOUD RC</b> Attuatore a catena radiocomandato</p>		
<p><b>ARX.20.02</b></p> <p>Descrizione <b>WI-CONTROL</b> Radiocomando</p>		
<p><b>ACX.20.03</b></p> <p>Descrizione <b>WI-CLOUD</b> Attuatore a catena radiocomandato</p>		
<p><b>ACX.20.04</b></p> <p>Descrizione <b>WI-CLOUD RC-LOCK</b> Attuatore a catena con serratura elettromeccanica</p>		



## Guarnizioni

<p><b>ARX.10.01</b></p> <p>Descrizione Guarnizione Centrale di Precamera</p>		<p><b>ARX.10.11</b></p> <p>Descrizione Guarnizione supplementare di Precamera</p>	
<p><b>ARX.10.02</b></p> <p>Descrizione Angolo per guarnizione centrale di Precamera art. ARX.10.61</p>		<p><b>ARX.10.12</b></p> <p>Descrizione Guarnizione vetro interna spessore 3 - 4 mm.</p>	
<p><b>ACX.10.03</b></p> <p>Descrizione Guarnizione di battuta a scatto</p>		<p><b>ARX.10.13</b></p> <p>Descrizione Guarnizione vetro interna spessore 5 - 6 mm.</p>	
<p><b>ACX.10.04</b></p> <p>Descrizione Guarnizione di battuta ad infilo</p>		<p><b>ARX.10.14</b></p> <p>Descrizione Guarnizione vetro interna spessore 7 - 8 mm.</p>	
<p><b>ARX.10.05</b></p> <p>Descrizione Guarnizione vetro esterna per isolamento termico-acustico</p>		<p><b>ARX.10.15</b></p> <p>Descrizione Guarnizione vetro interna spessore 9 - 10 mm.</p>	
<p><b>ARX.10.05.1</b></p> <p>Descrizione Guarnizione vetro esterna coestrusa per isolamento termico-acustico</p>		<p><b>ARX.10.16</b></p> <p>Descrizione Guarnizione perimetrale</p>	
<p><b>ARX.10.06</b></p> <p>Descrizione Guarnizione sottovetro per isolamento termico-acustico</p>		<p><b>ARX.10.27</b></p> <p>Descrizione Rotella infila guarnizioni</p>	
<p><b>ARX.10.07</b></p> <p>Descrizione Guarnizione di battuta esterna acustica esterna mm.1</p>		<p><b>ASX.10.35</b></p> <p>Descrizione Guarnizione rigida per porte</p>	
<p><b>ARX.10.08</b></p> <p>Descrizione Guarnizione di battuta per ferramenta a nastro</p>		<p><b>ACX.10.71</b></p> <p>Descrizione Articolo per fermavetro di sicurezza (a pezzi)</p>	
<p><b>ARX.10.09</b></p> <p>Descrizione Canalina isolante per ferramenta a nastro</p>		<p><b>ARX.10.28</b></p> <p>Descrizione Guarnizione vetro esterna coestrusa mm. 1.5</p>	
<p><b>ARX.10.10</b></p> <p>Descrizione Spazzola a pavimento</p>		<p><b>ARX.10.29</b></p> <p>Descrizione Guarnizione vetro esterna coestrusa mm. 3</p>	
<p><b>ARX.10.11</b></p> <p>Descrizione Guarnizione supplementare di Precamera</p>		<p><b>ARX.10.30</b></p> <p>Descrizione Guarnizione vetro esterna Dutral mm. 3</p>	

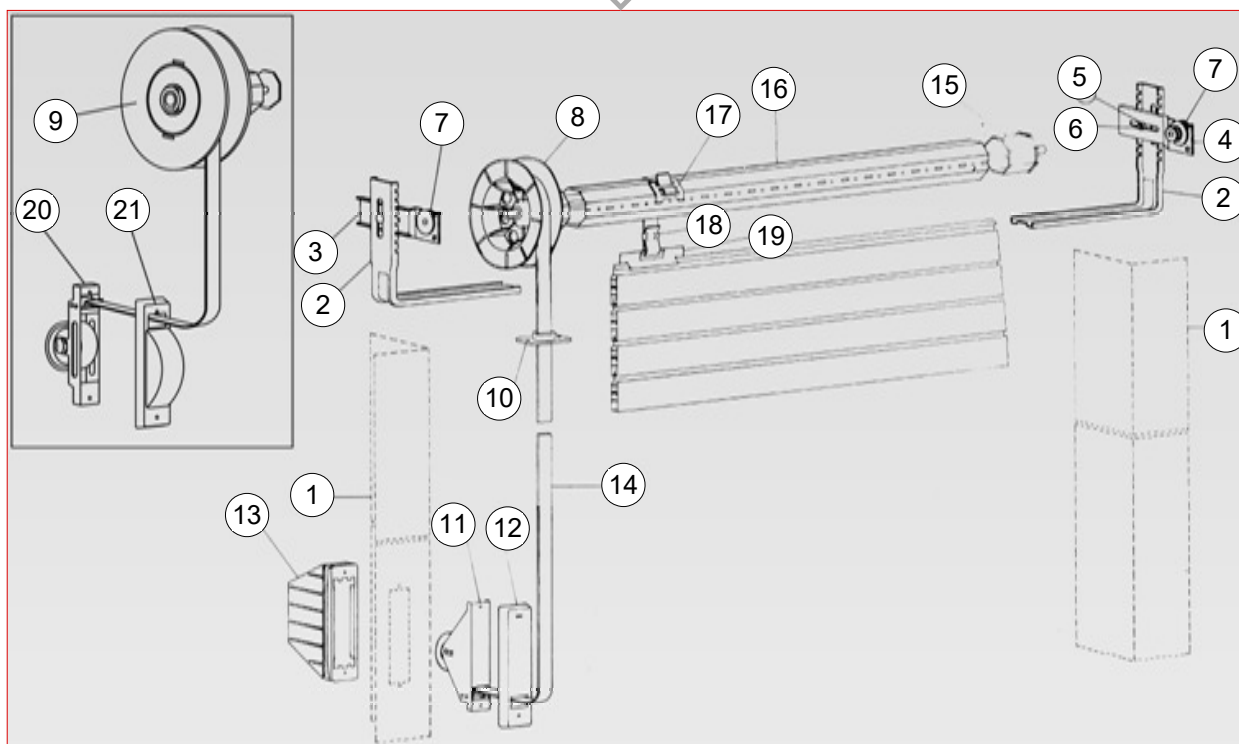
**Monoblocco - Soluzione con puleggia**

<b>ARX.11.01</b>	Supporto a squadro A = mm 46	2		2
<b>ARX.11.02</b>	Mensola per supporto (SIN)	1		3
<b>ARX.11.03</b>	Mensola per supporto (DX)	1		4
<b>ARX.11.04</b>	Vite 6 x 20 con dado	2		5 - 6
<b>ARX.11.05</b>	Boccola in nylon	2		7
<b>ARX.11.06</b>	Puleggia in plastica a minimo ingombro Ø 220	1	scegliere tipo	8
<b>ARX.11.07</b>	Guida cinghia trasversale in nylon	1	scegliere colore	10
<b>ARX.11.08</b>	Avvolgitore	1		11
<b>ARX.11.09</b>	Placca	1	scegliere tipo	12
<b>ARX.11.10</b>	Cassetta	1	scegliere tipo	13
<b>ARX.11.11</b>	Cintino	Mt.	scegliere tipo	14
<b>ARX.11.12</b>	Calotta in plastica	1		15
<b>ARX.11.13</b>	Rullo ottagonale	Mt.	scegliere tipo	16
<b>ARX.11.14</b>	Gancio per attacco cintino al rullo	2		17
<b>ARX.11.15</b>	Grappa fermacintino	2		18
<b>ARX.11.16</b>	Gancio per avvolgibili in plastica con asola	2		19

**Monoblocco - Soluzione con puleggia**

<b>ARX.11.18</b>	Riduttore portata 40 kg. R=1:2,6 Puleggia Ø 220	1		9
<b>ARX.11.19</b>	Avvolgitore	1		20
<b>ARX.11.20</b>	Placca	1	scegliere tipo	21

**Vari**

<b>ARX.11.21</b>	Invito tapparella in nylon su profilo in alluminio
<b>ARX.11.22</b>	Coppia tappi laterali cassonetto in alluminio





Sezioni

Gruppo D

Sezioni principali  
in scala 1:1  
corredate dei relativi accessori





**SCHEMA DIMENSIONALE**

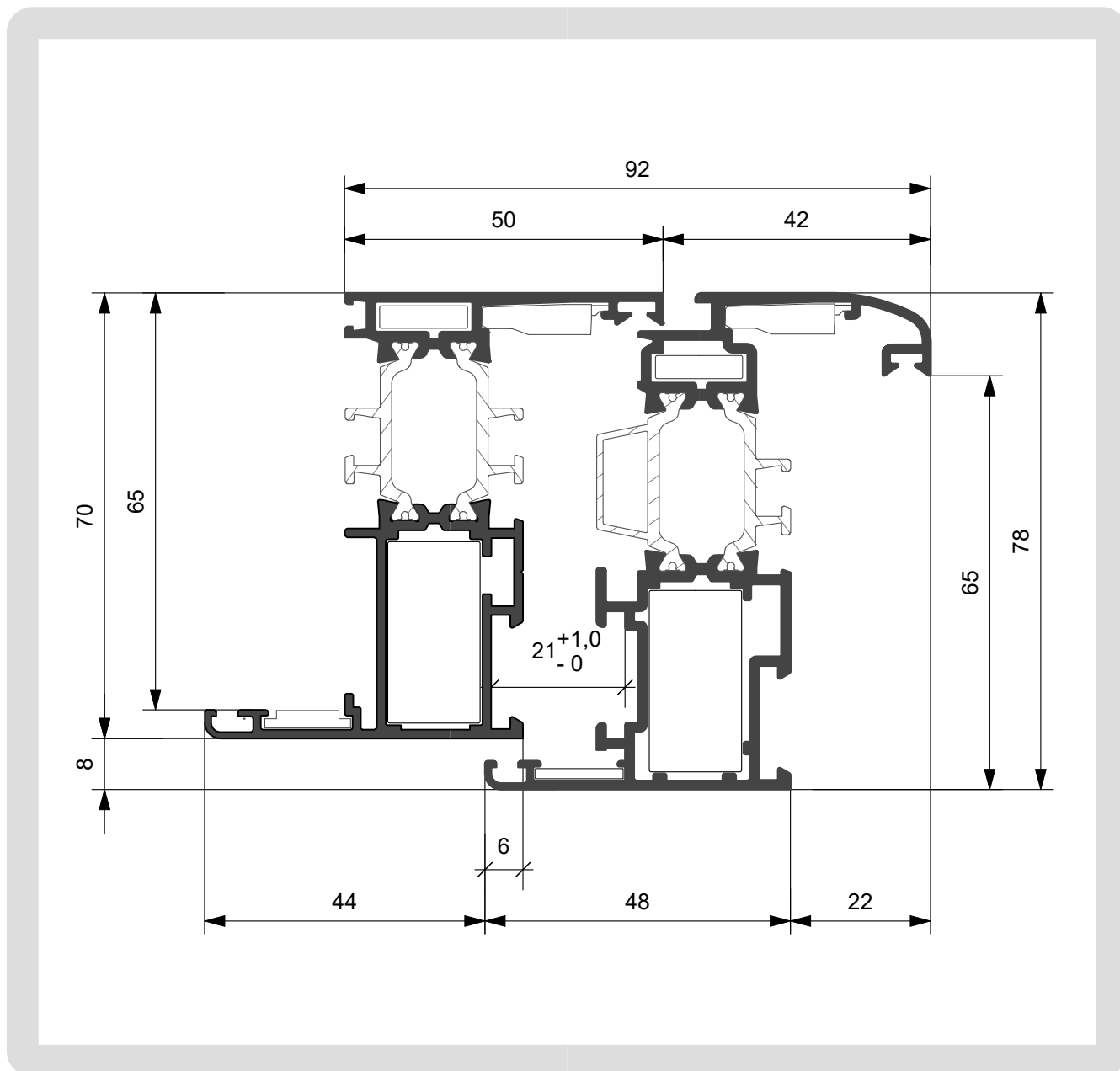



**FINESTRA A DUE ANTE**

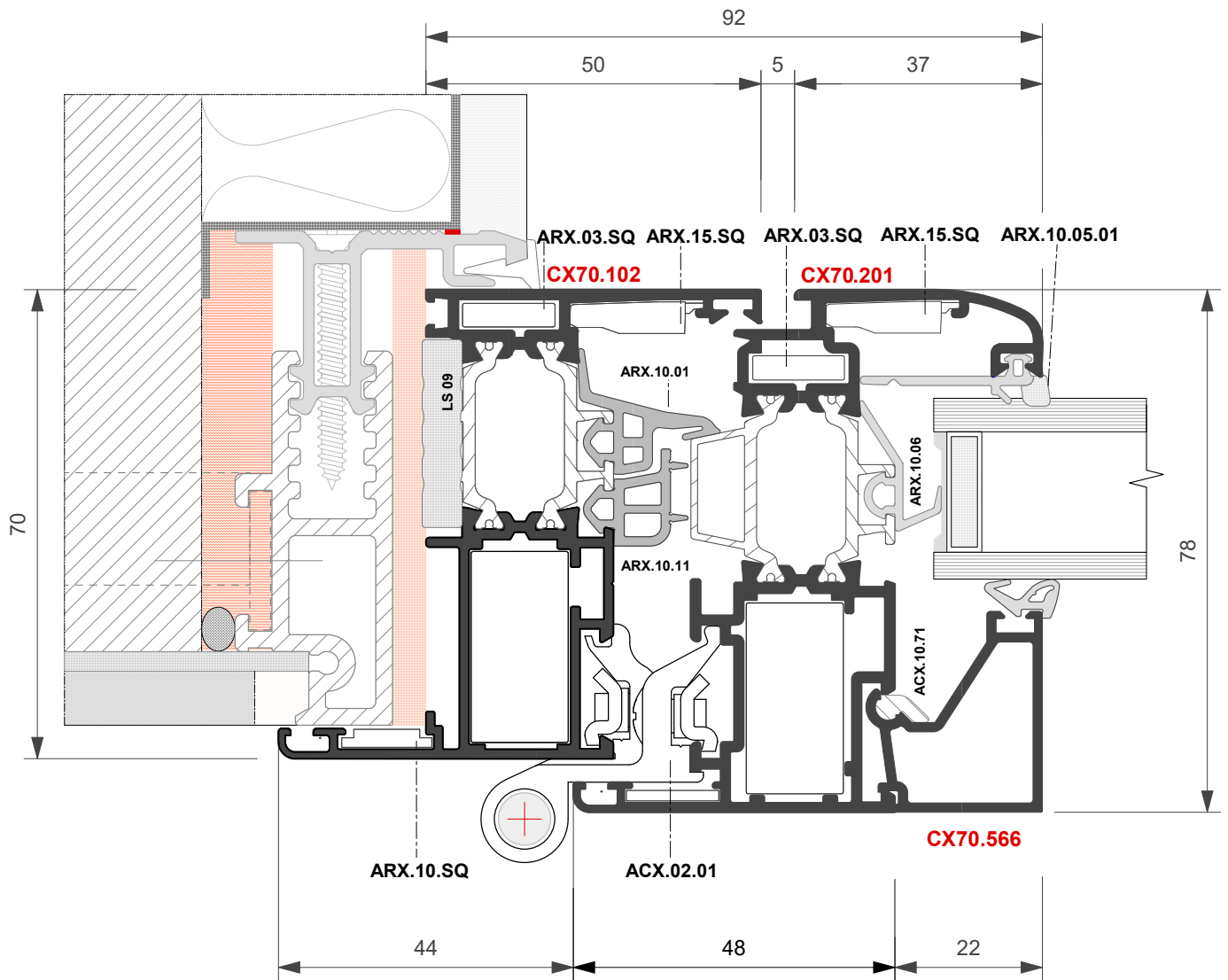
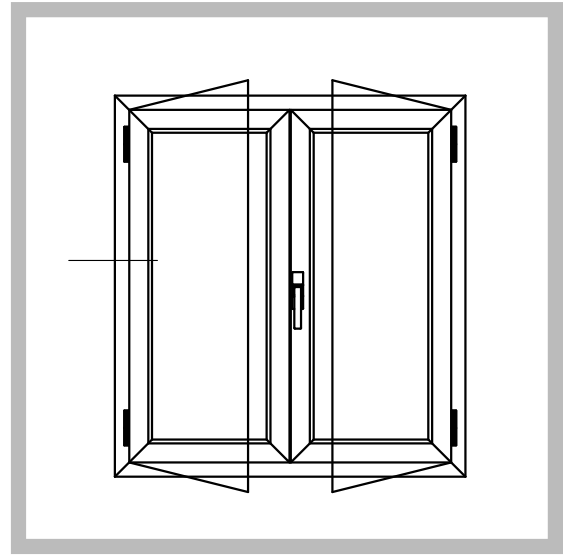



**FINESTRA A DUE ANTE**

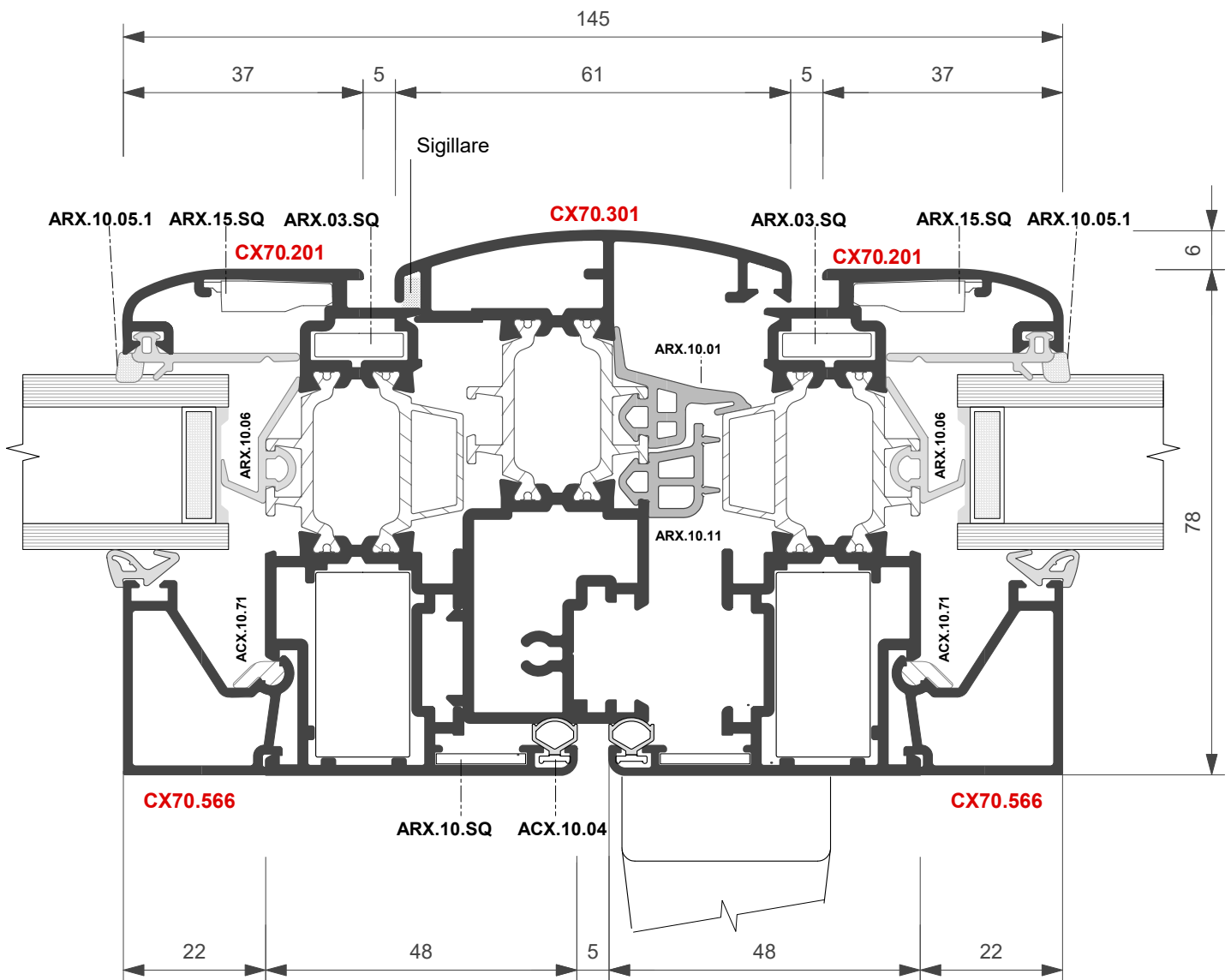
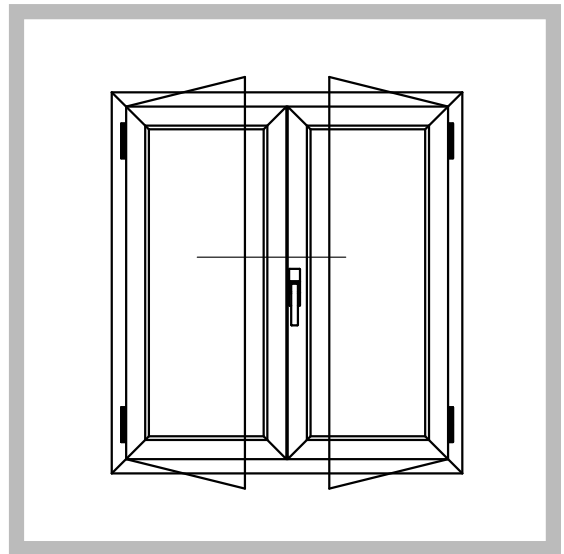



**FINESTRA A DUE ANTE**

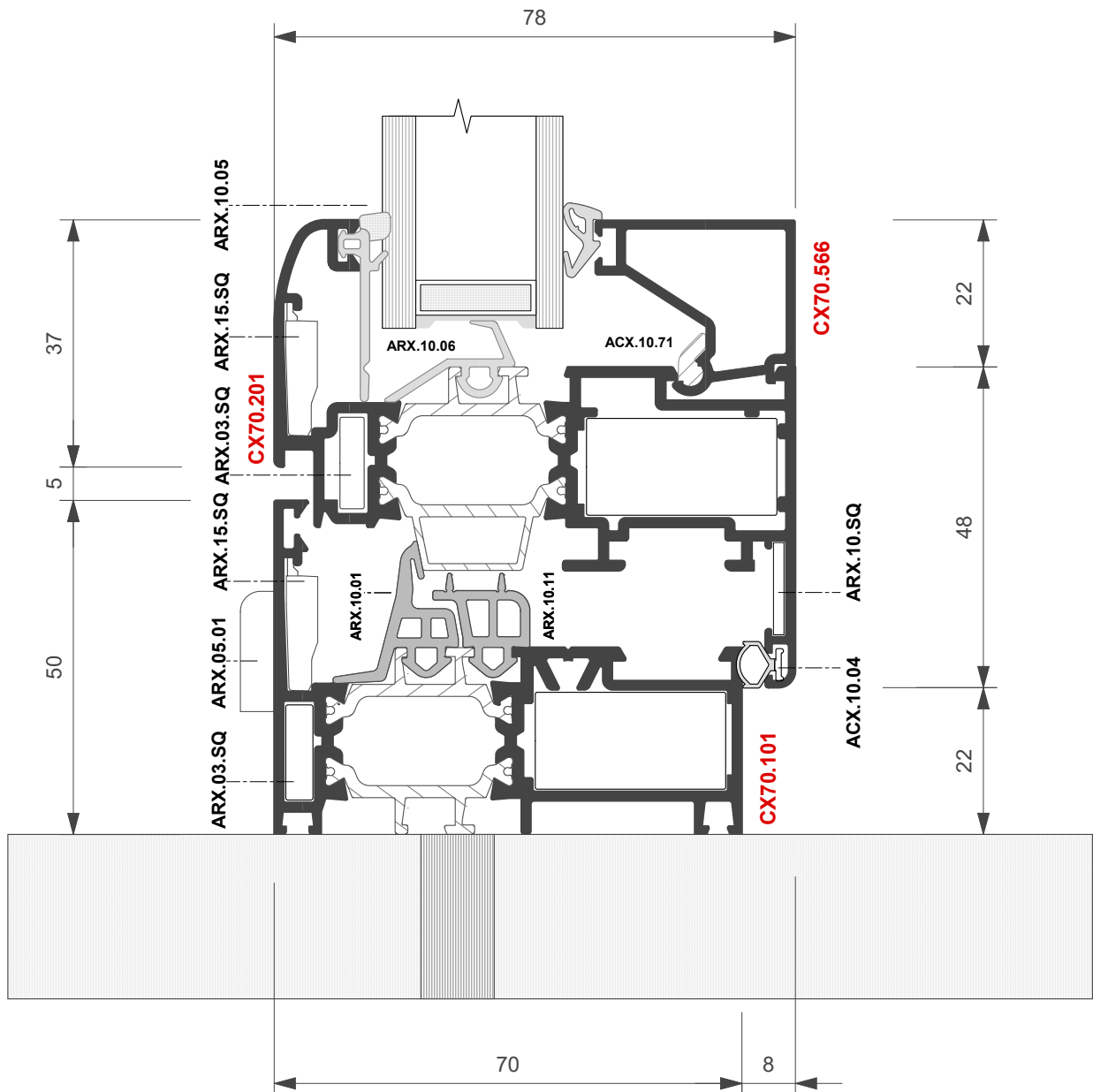
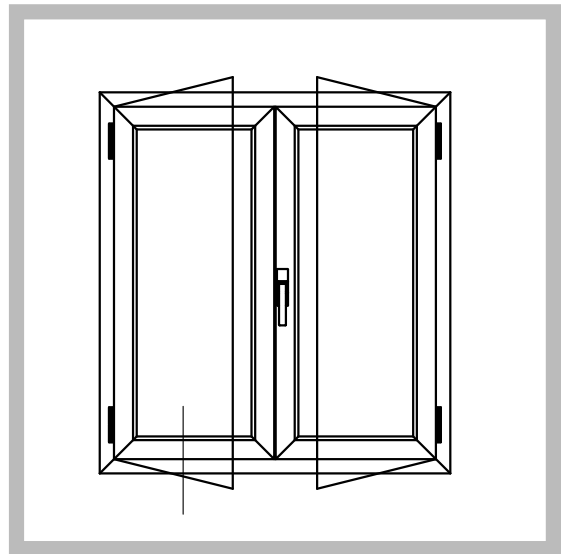



PORTA BALCONE A DUE ANTE

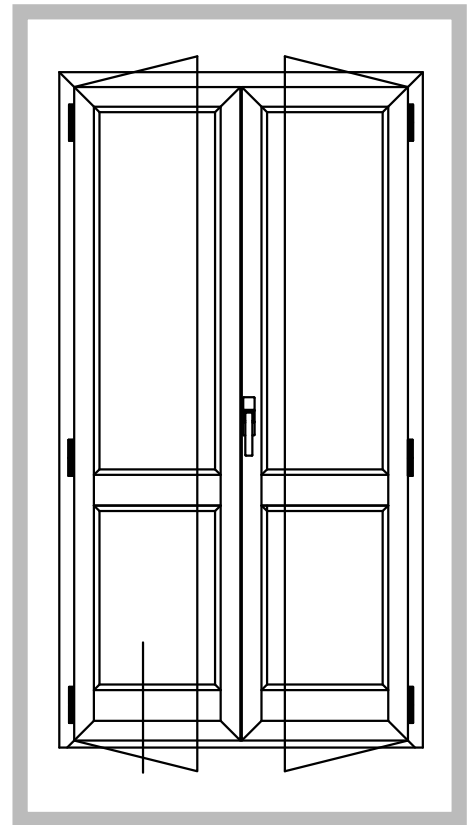
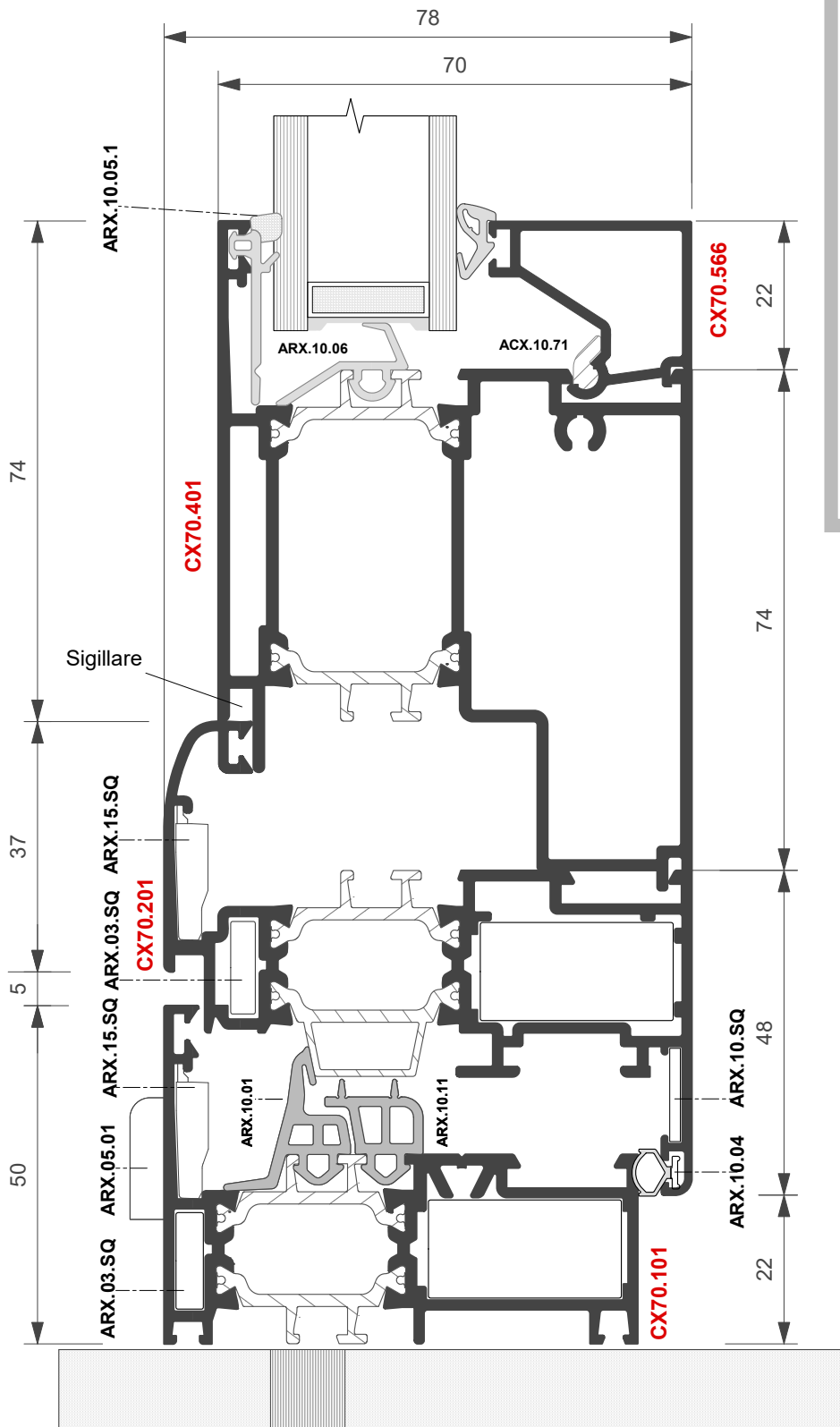



**PORTA BALCONE A DUE ANTE**  
con soglia bassa

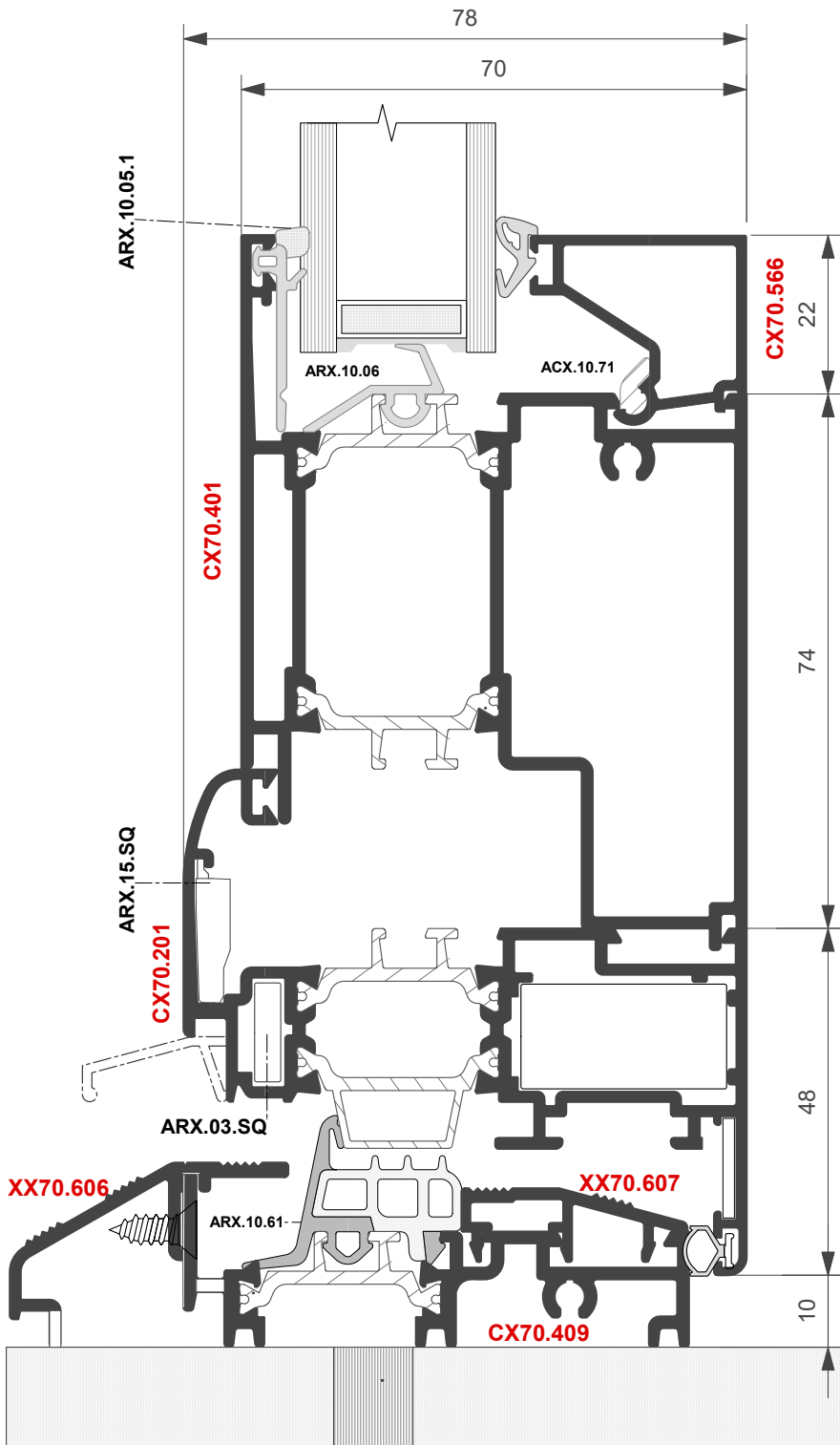
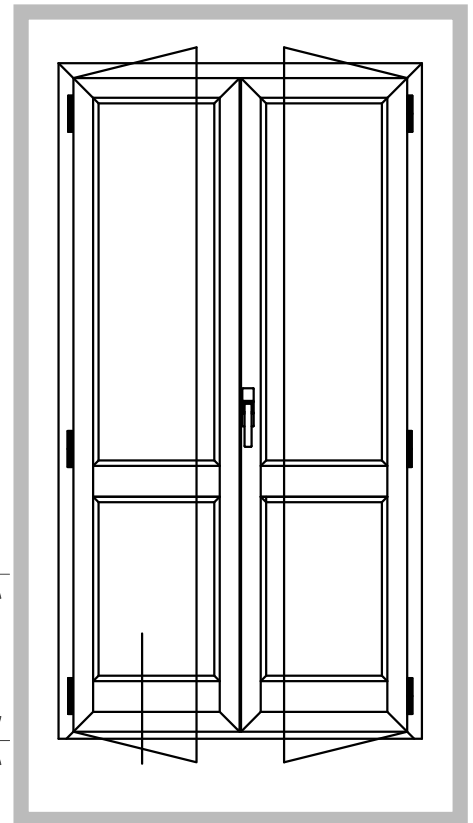



**PORTA BALCONE A DUE ANTE**

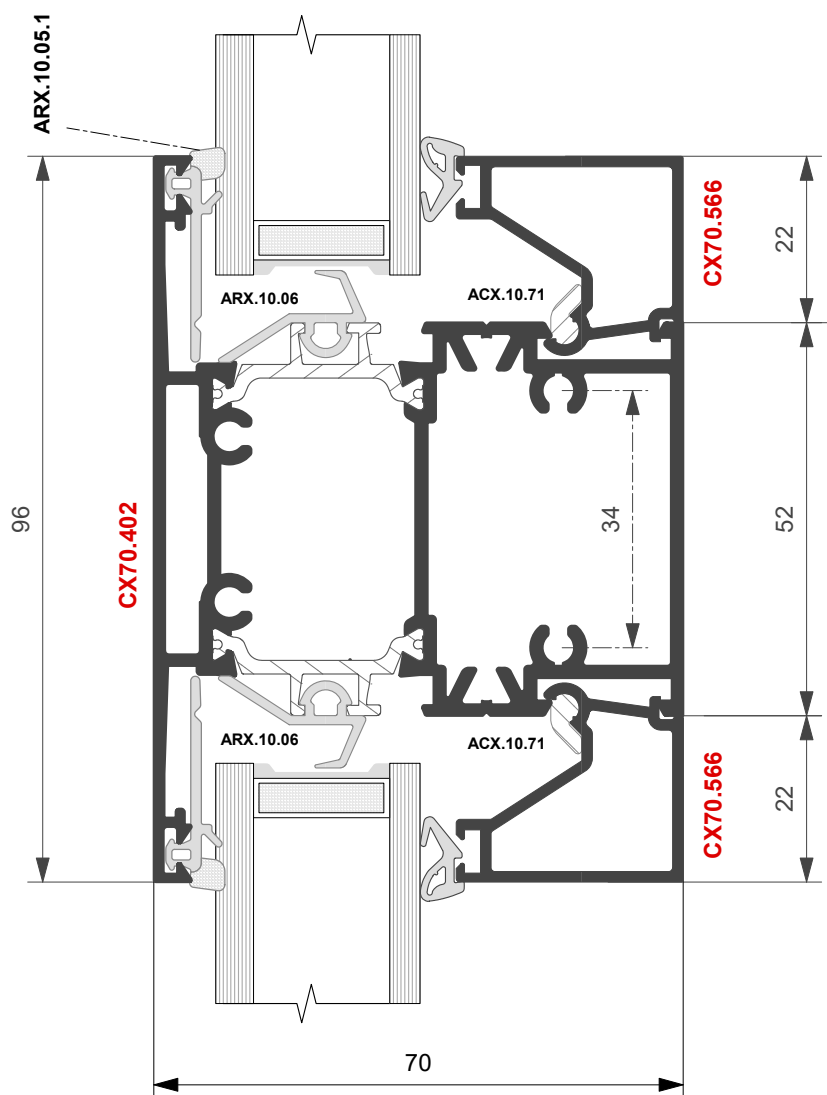





**FINESTRA A DUE ANTE**

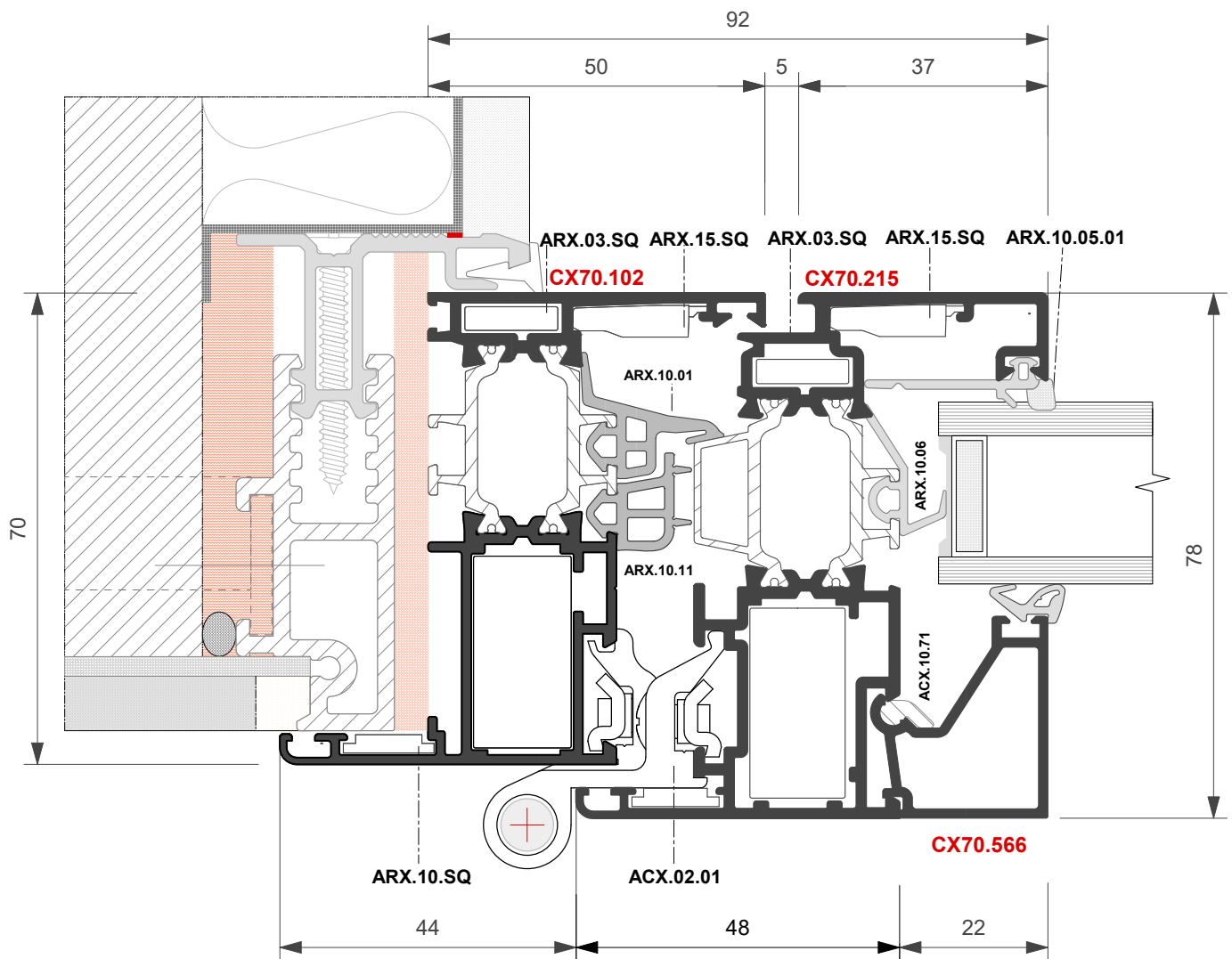
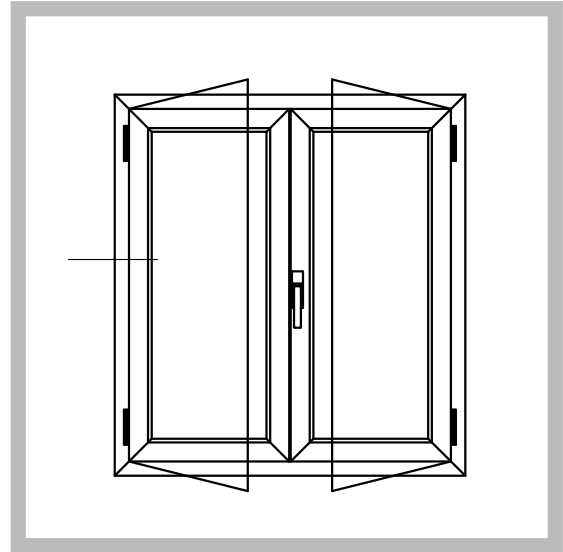



**FINESTRA A DUE ANTE**

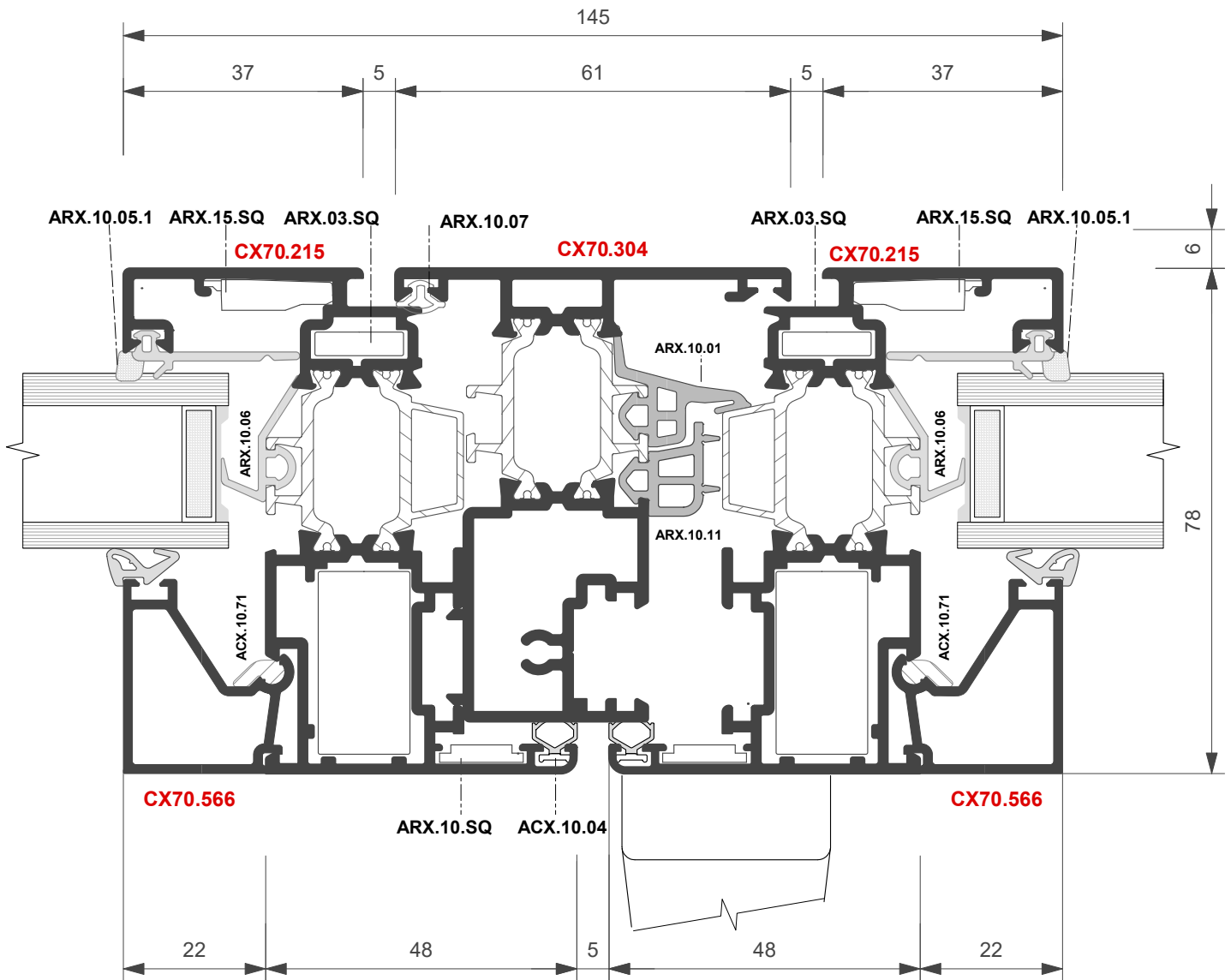
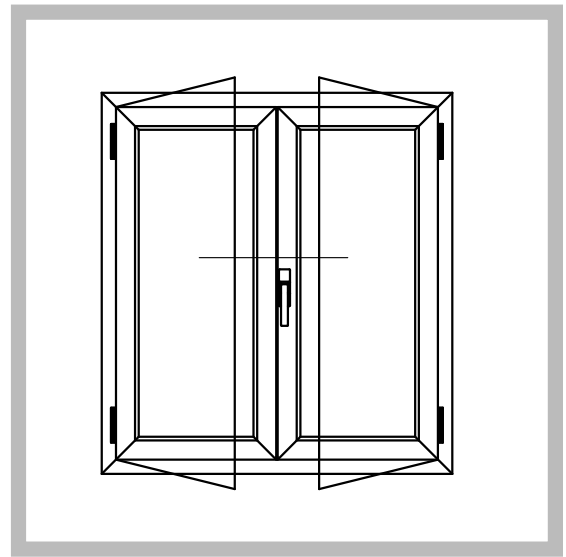



**FINESTRA A DUE ANTE**

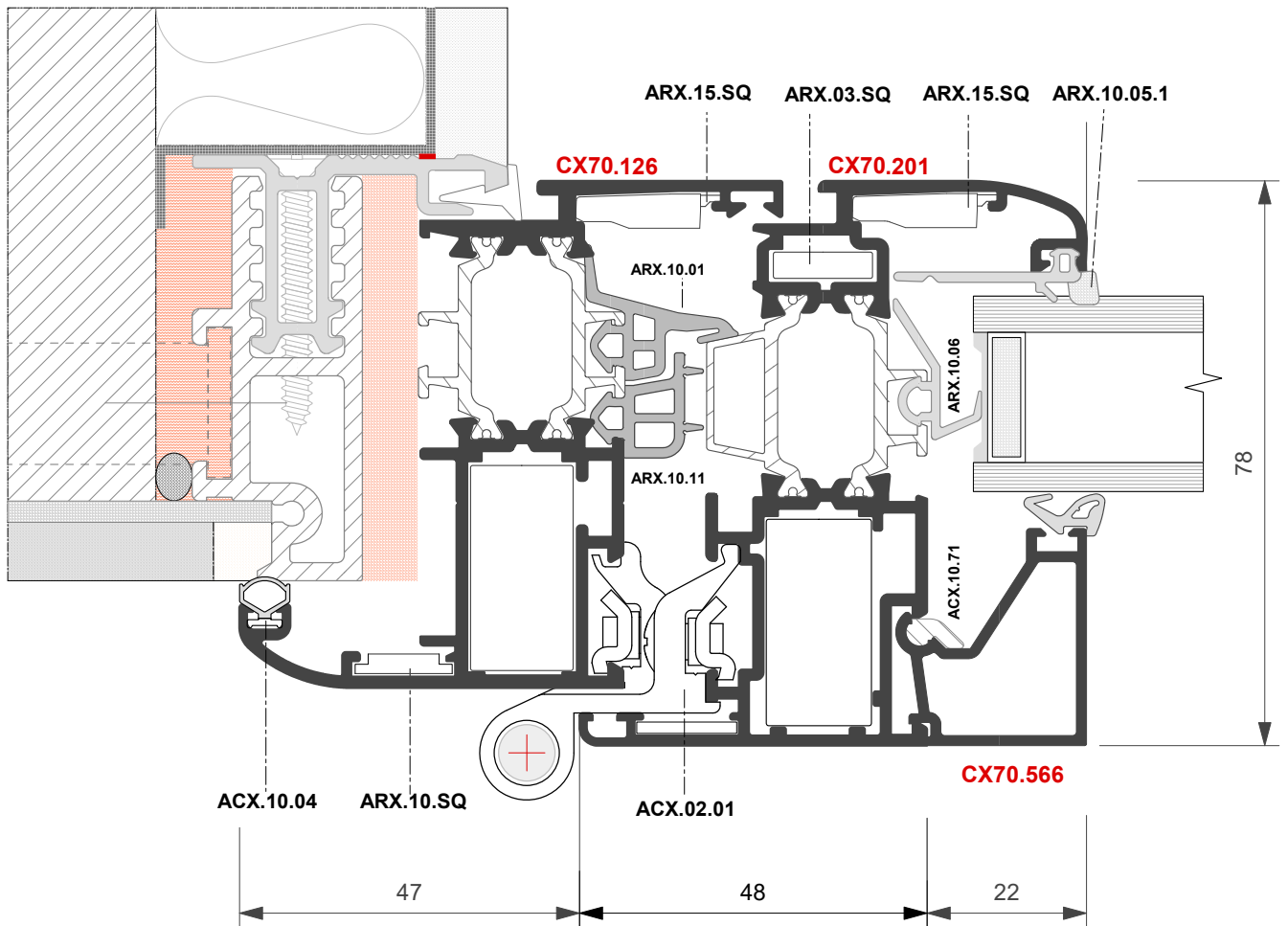
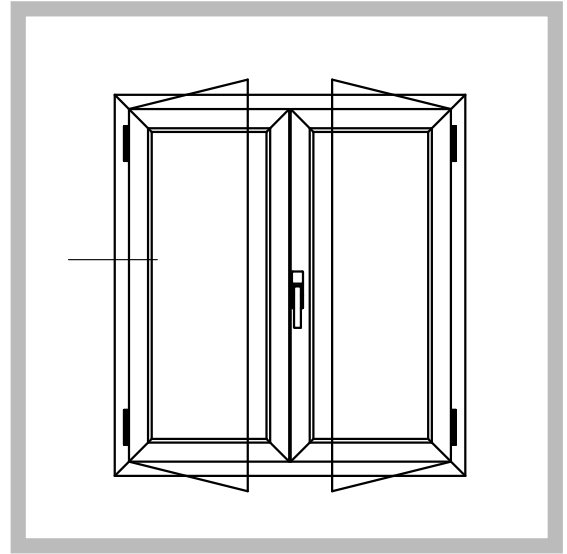



**FINESTRA A DUE ANTE**  
Vetro ad infilare

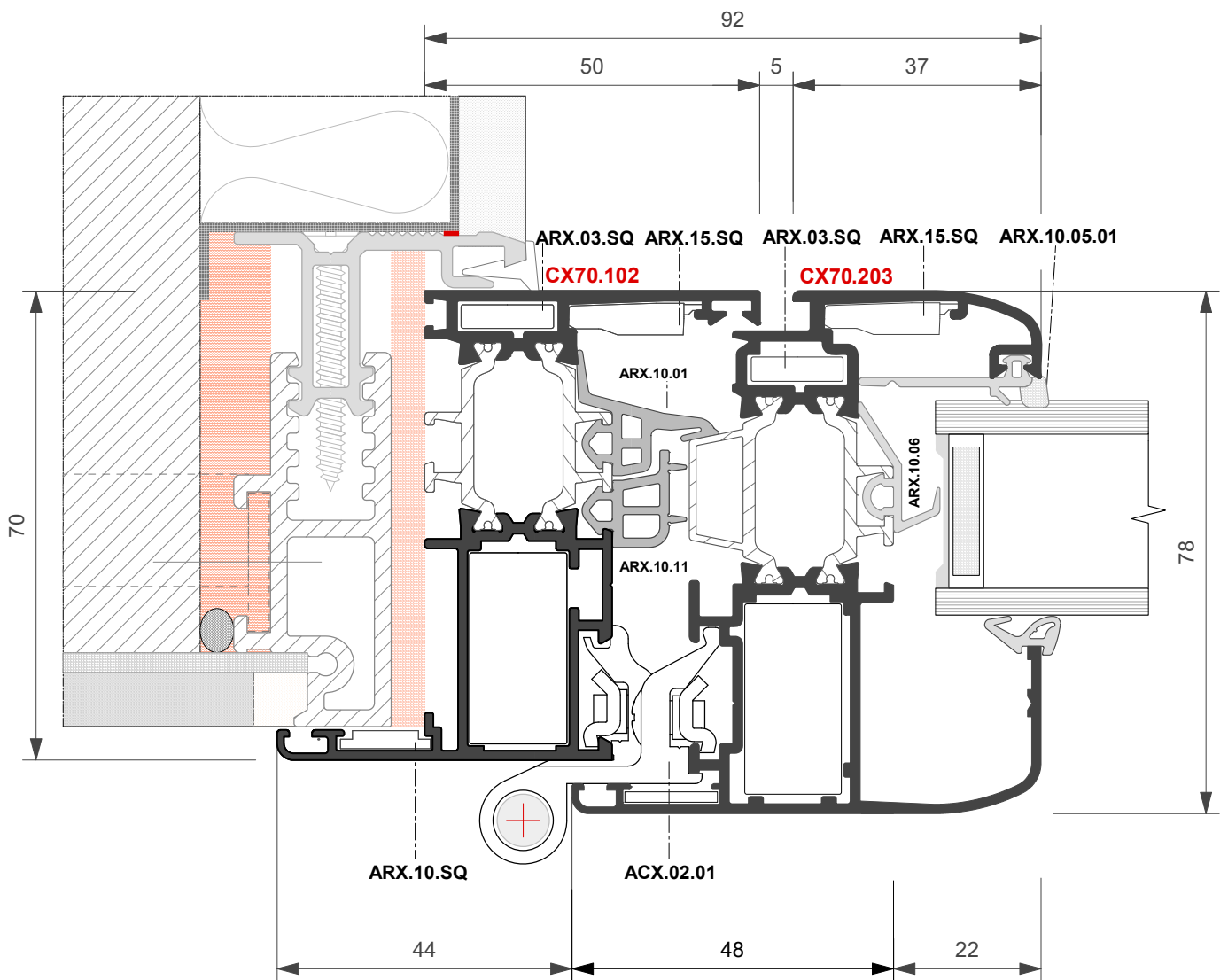
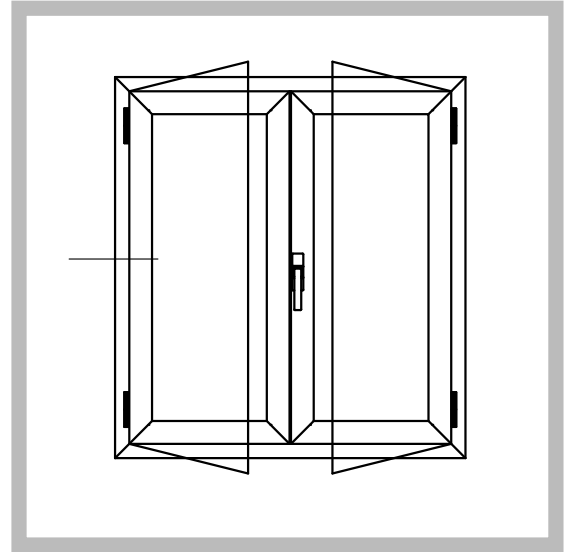



**FINESTRA A DUE ANTE**  
Vetro ad infilare

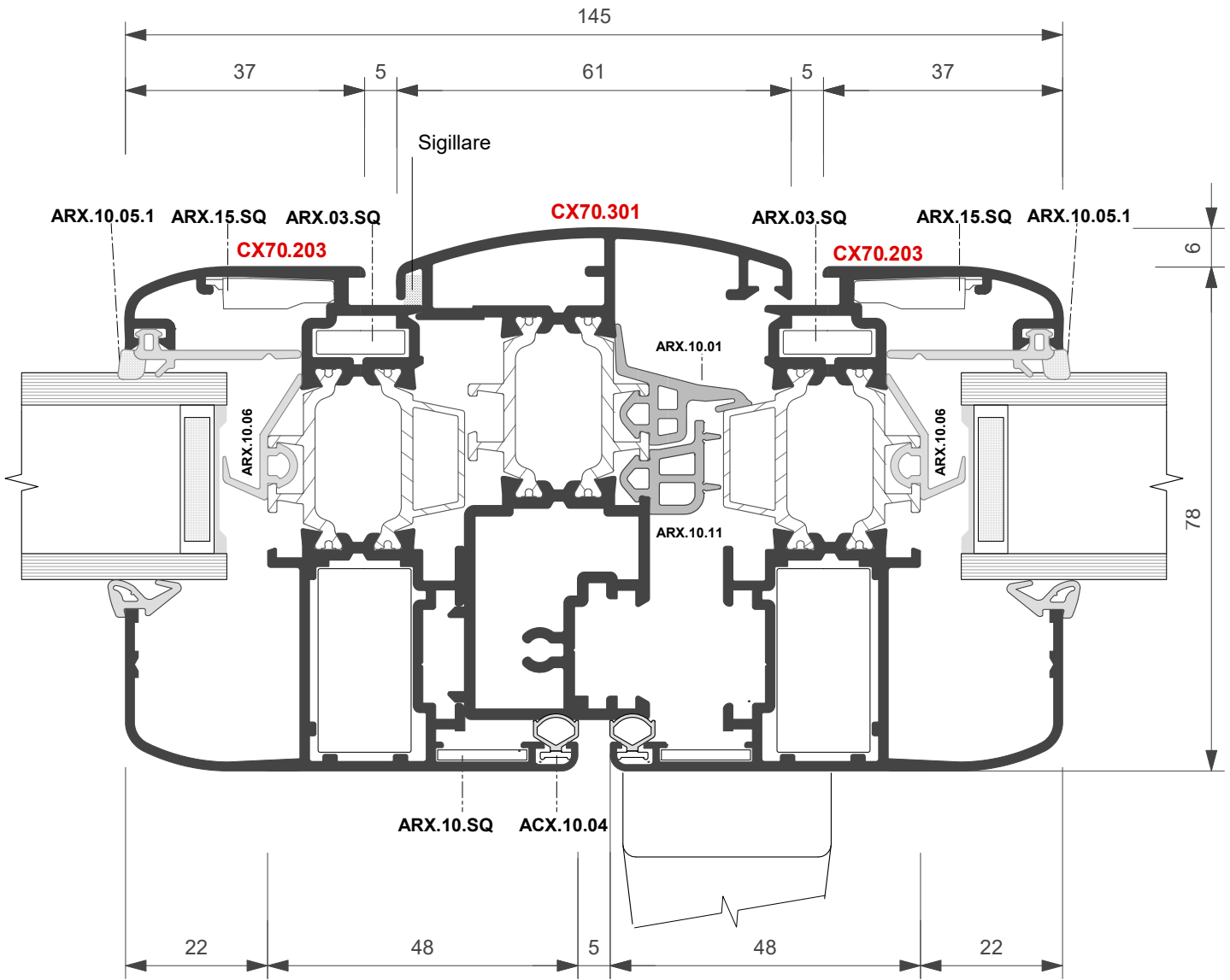
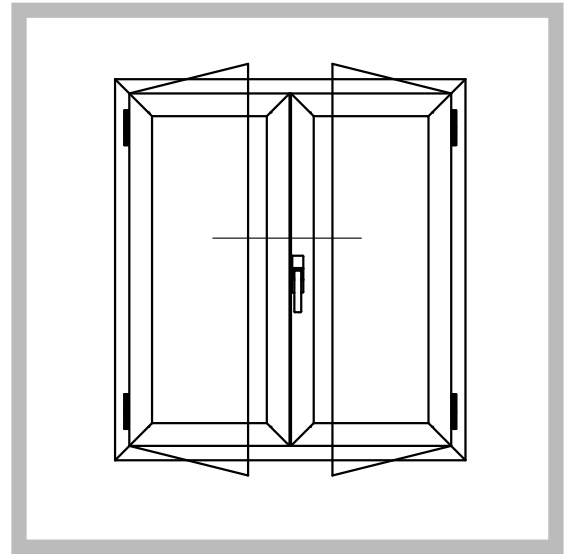



**PORTA BALCONE A DUE ANTE**  
Vetro ad infilare

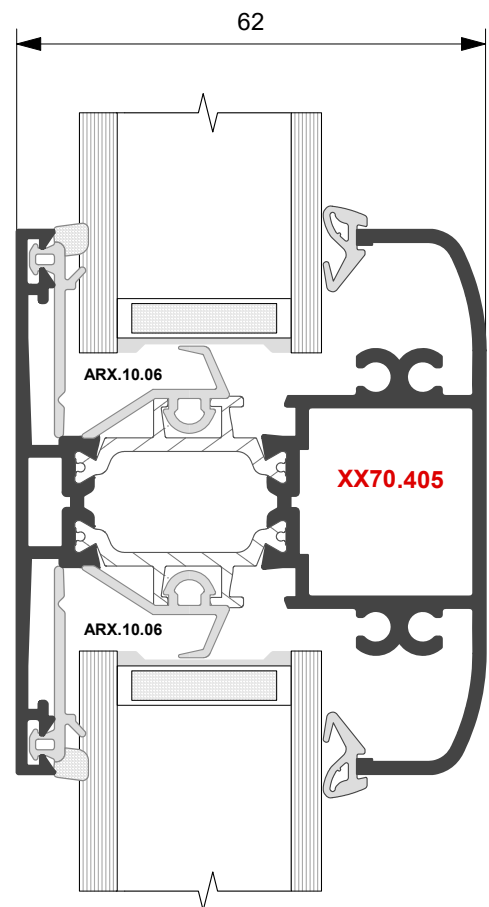
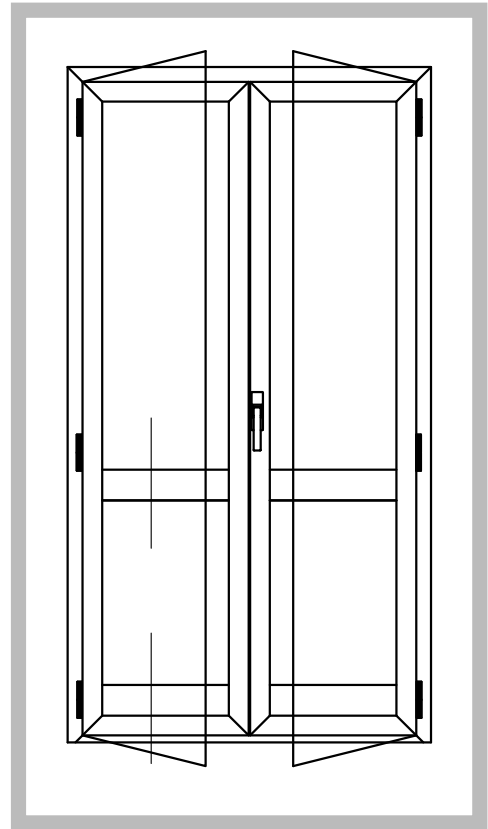
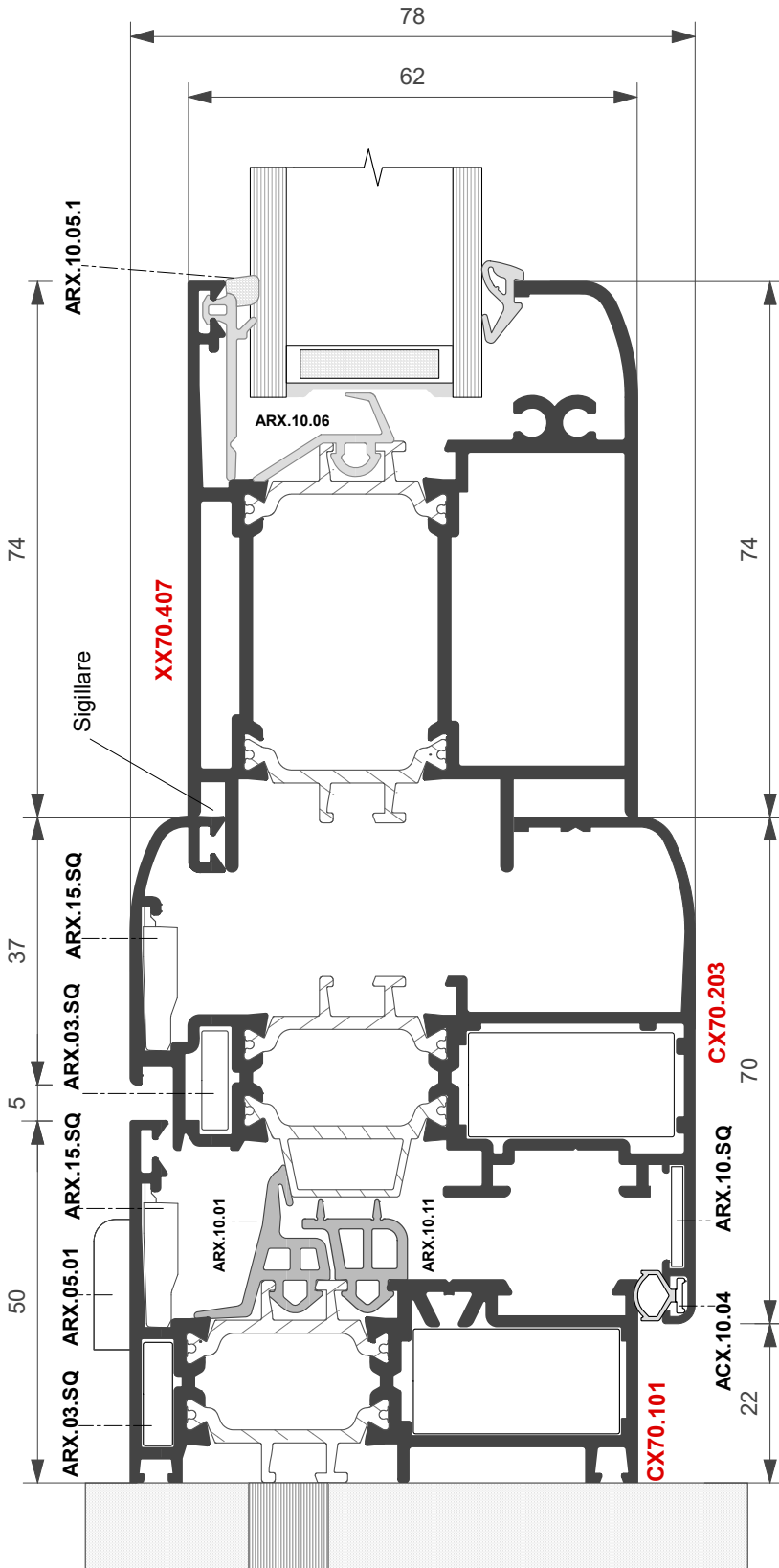



**FINESTRA A DUE ANTE**  
Vetro ad infilare

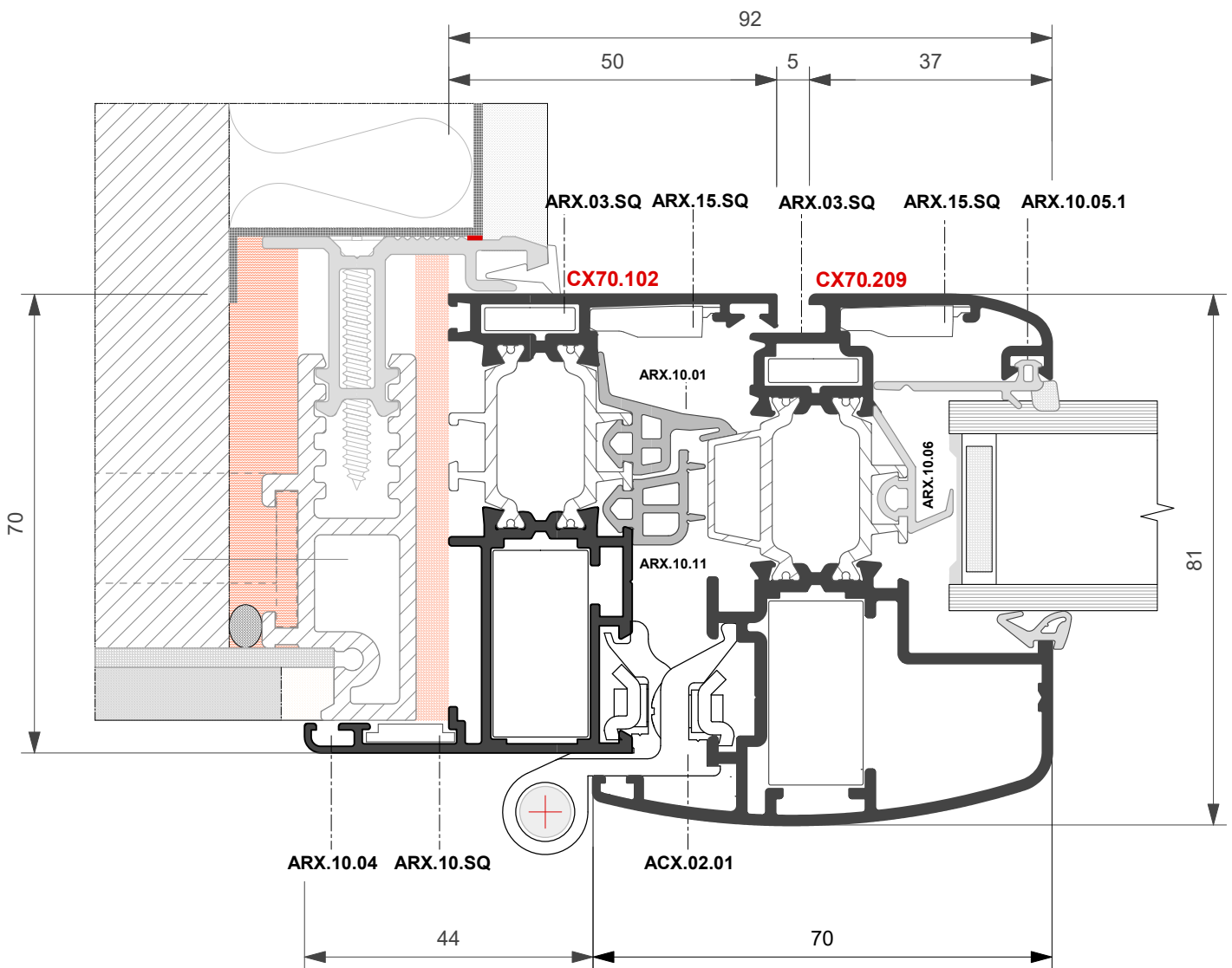
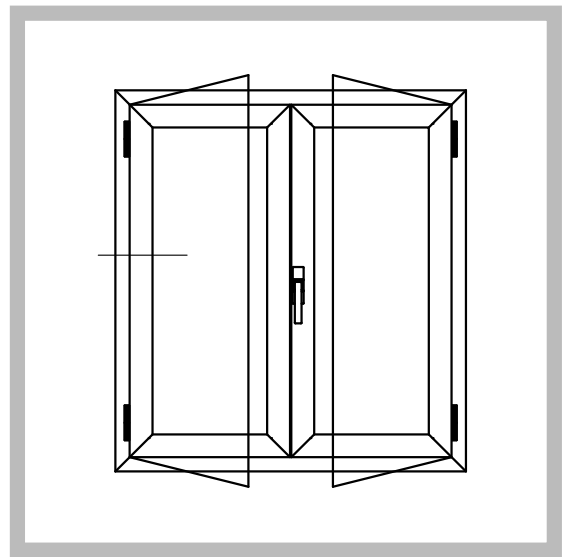



**FINESTRA A DUE ANTE**  
Vetro ad infilare

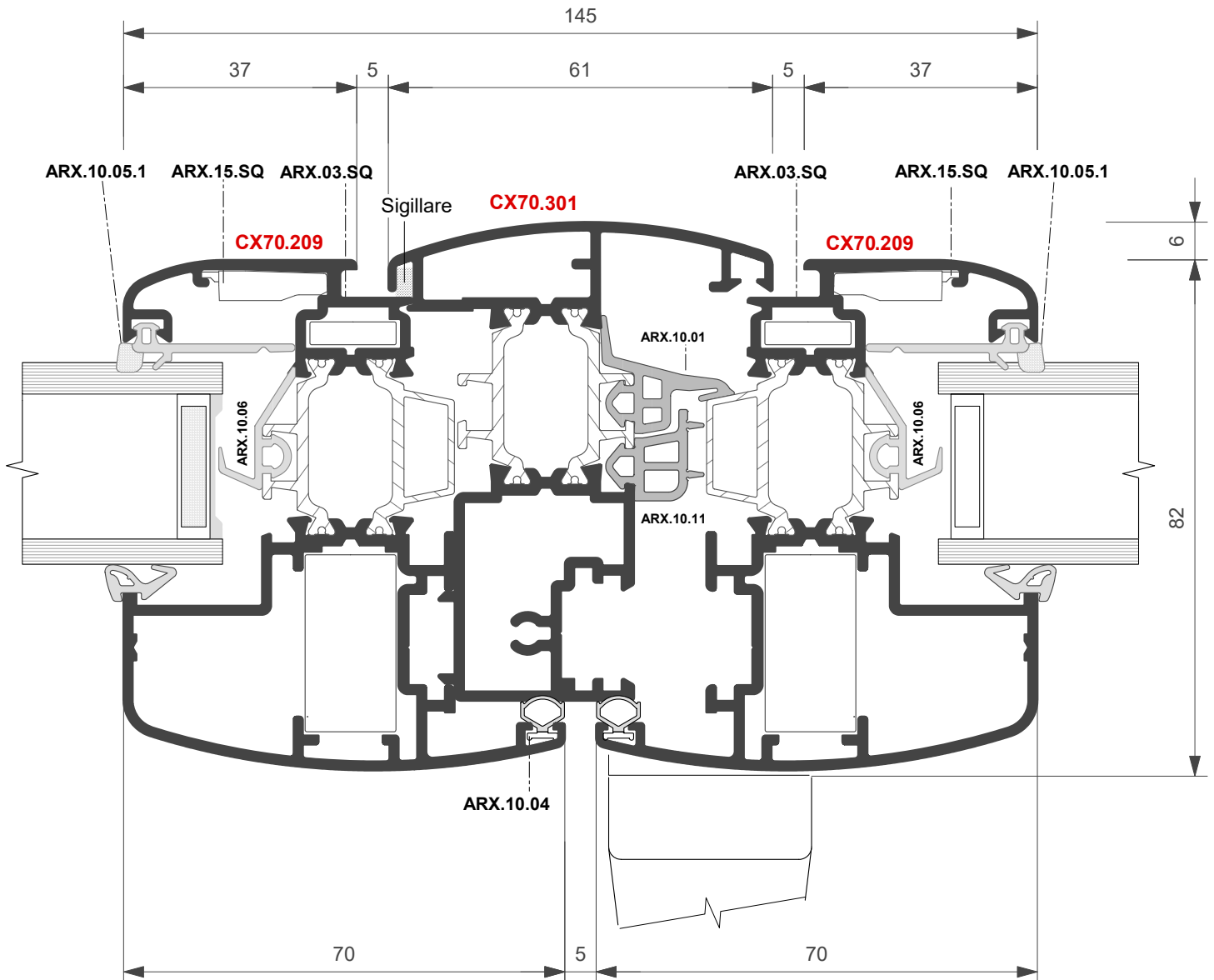
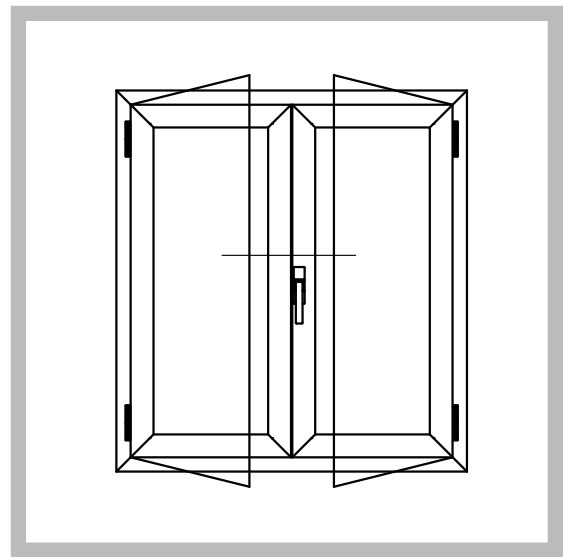





**FINESTRA A DUE ANTE**  
**Vetro ad infilare**

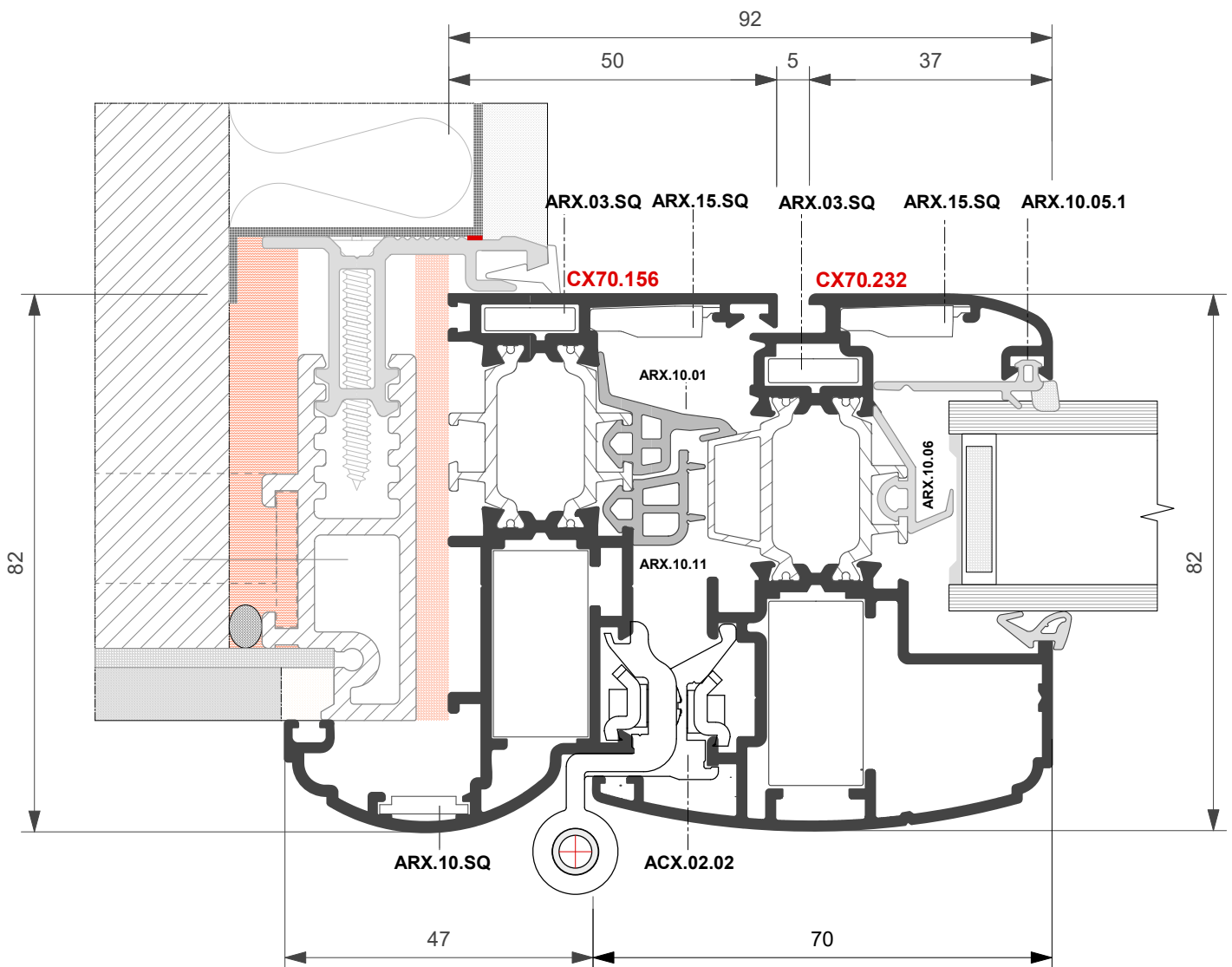
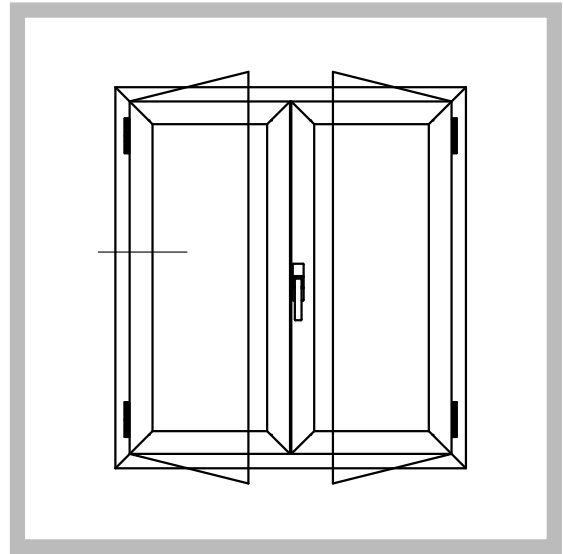



**FINESTRA A DUE ANTE**  
Vetro ad infilare

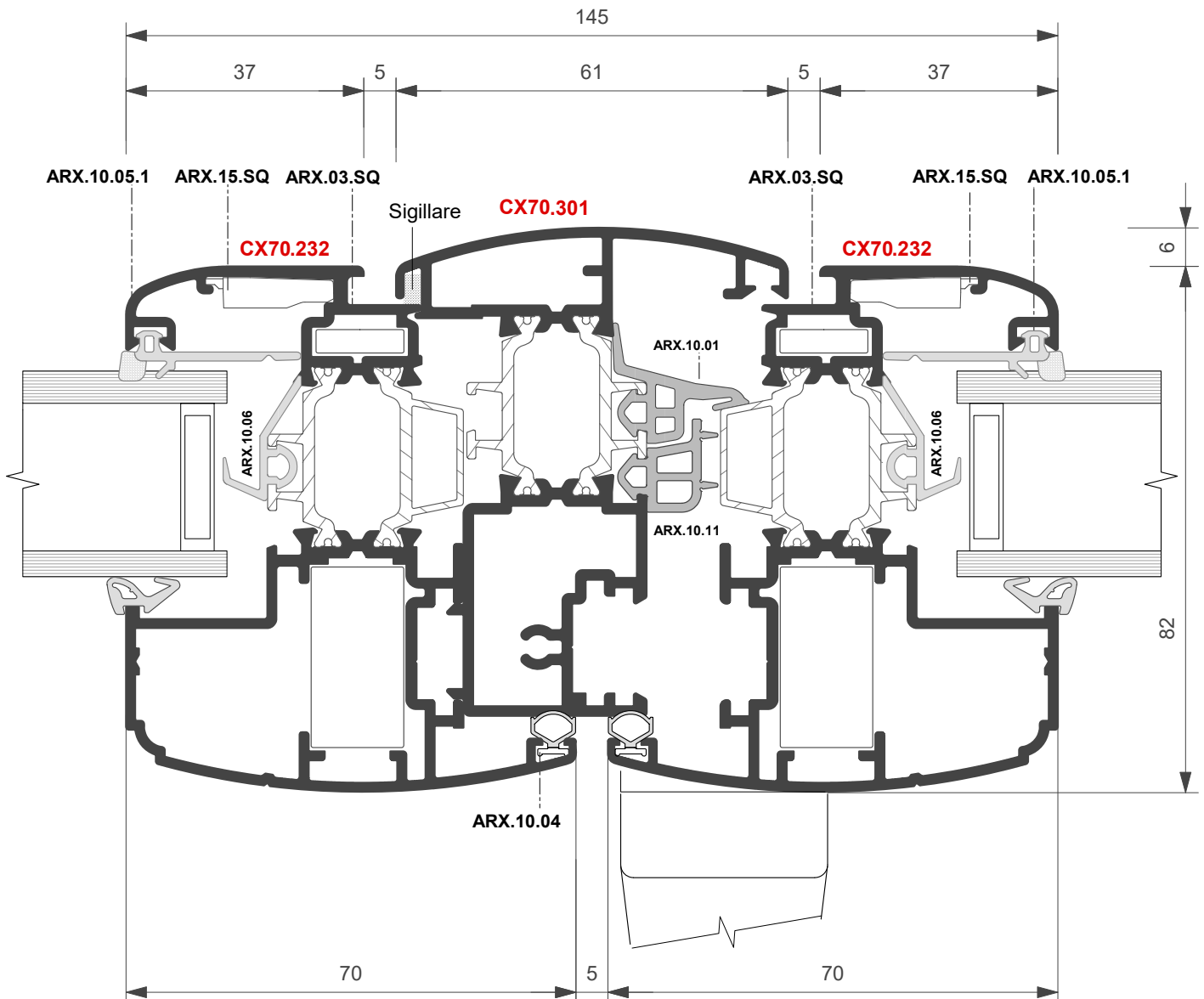
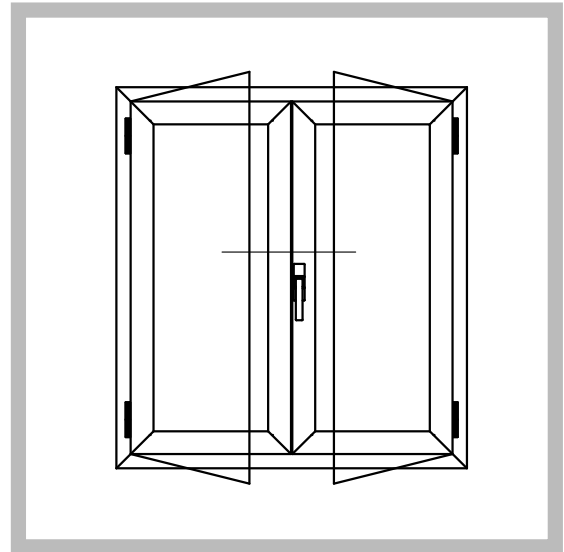



**PORTA BALCONE A DUE ANTE**  
Vetro ad infilare

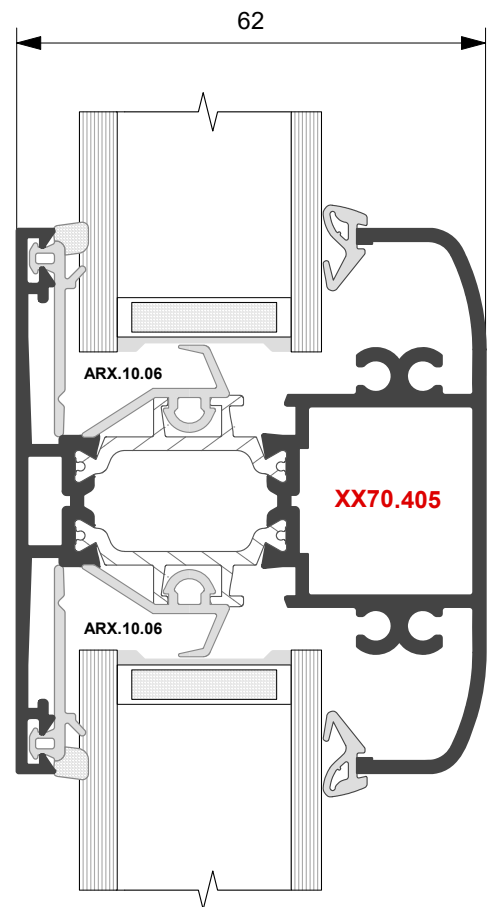
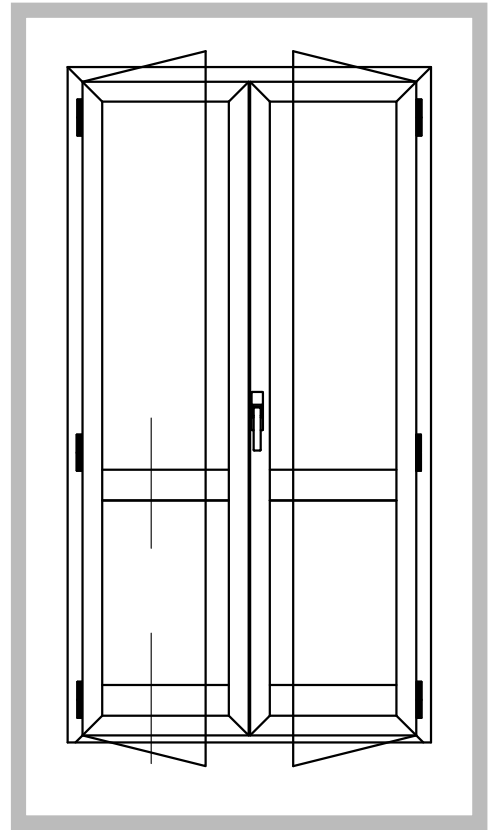
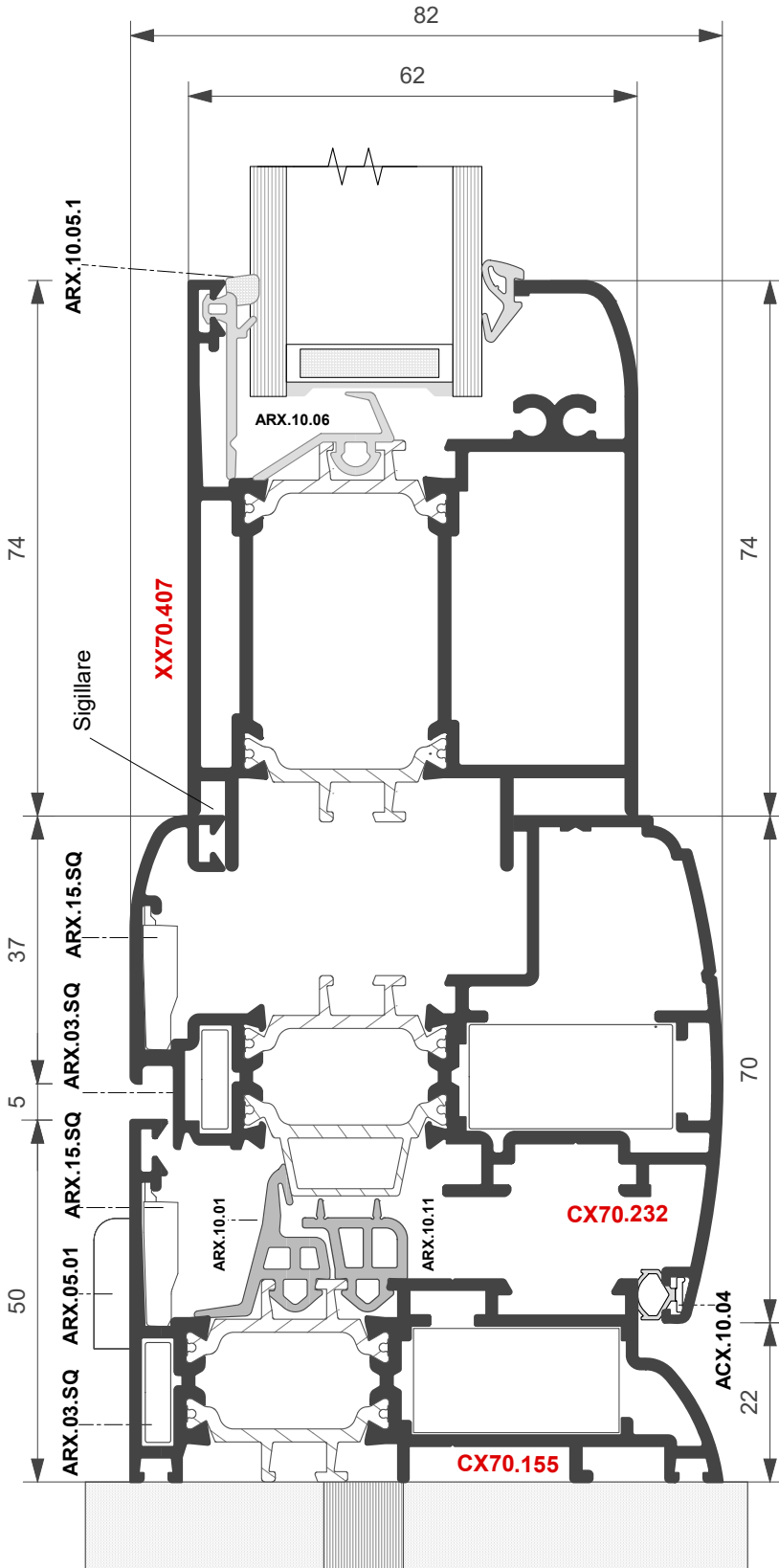

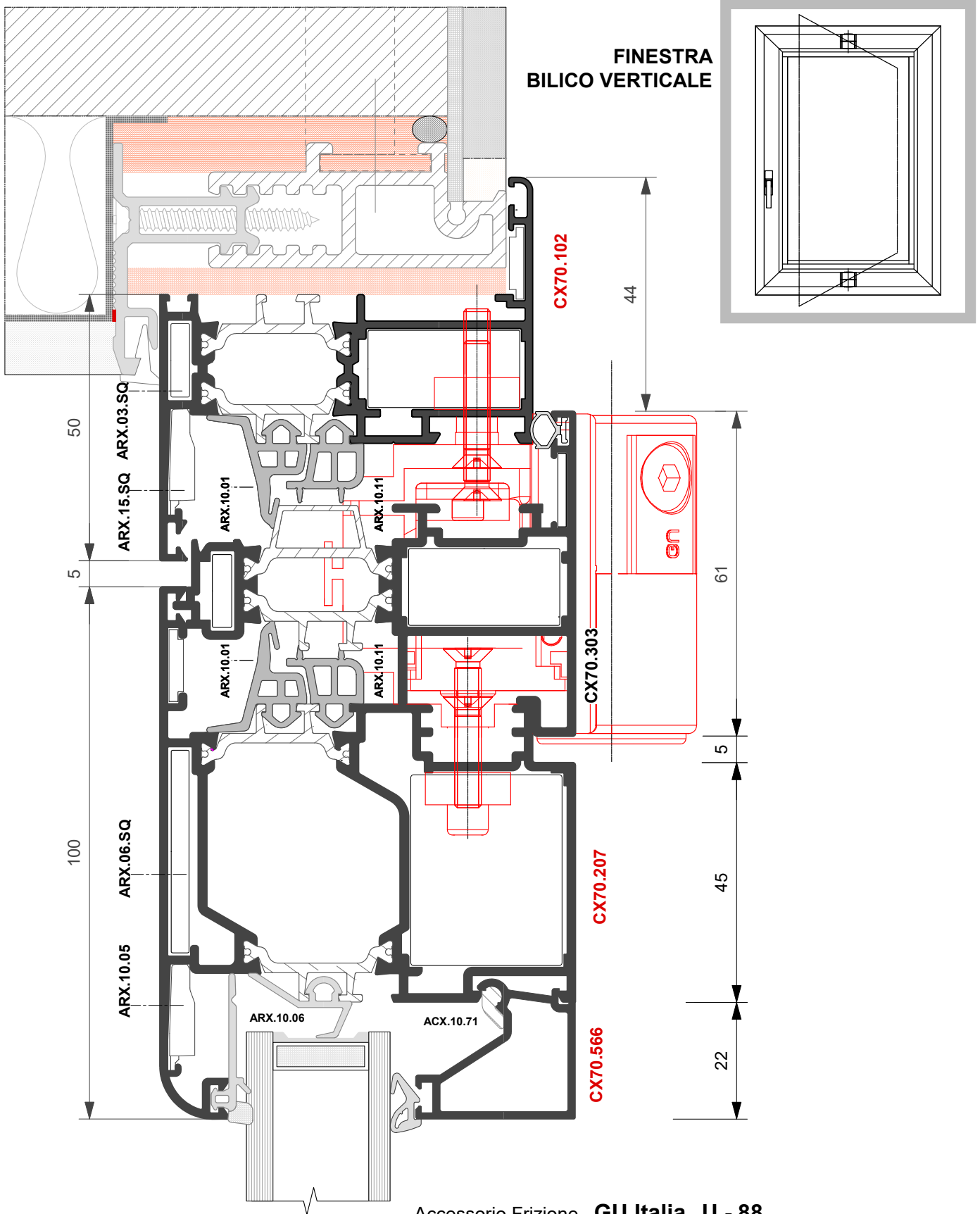

Accessorio Frizione **GU Italia U - 88**  
**Articolo 6 - 27337-08 - P**  
 per accessori di movimentazione riferirsi  
 alla tavola di assieme

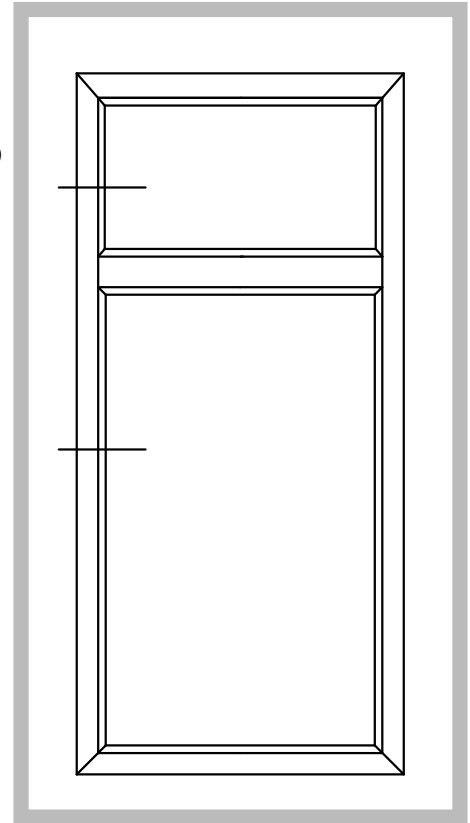
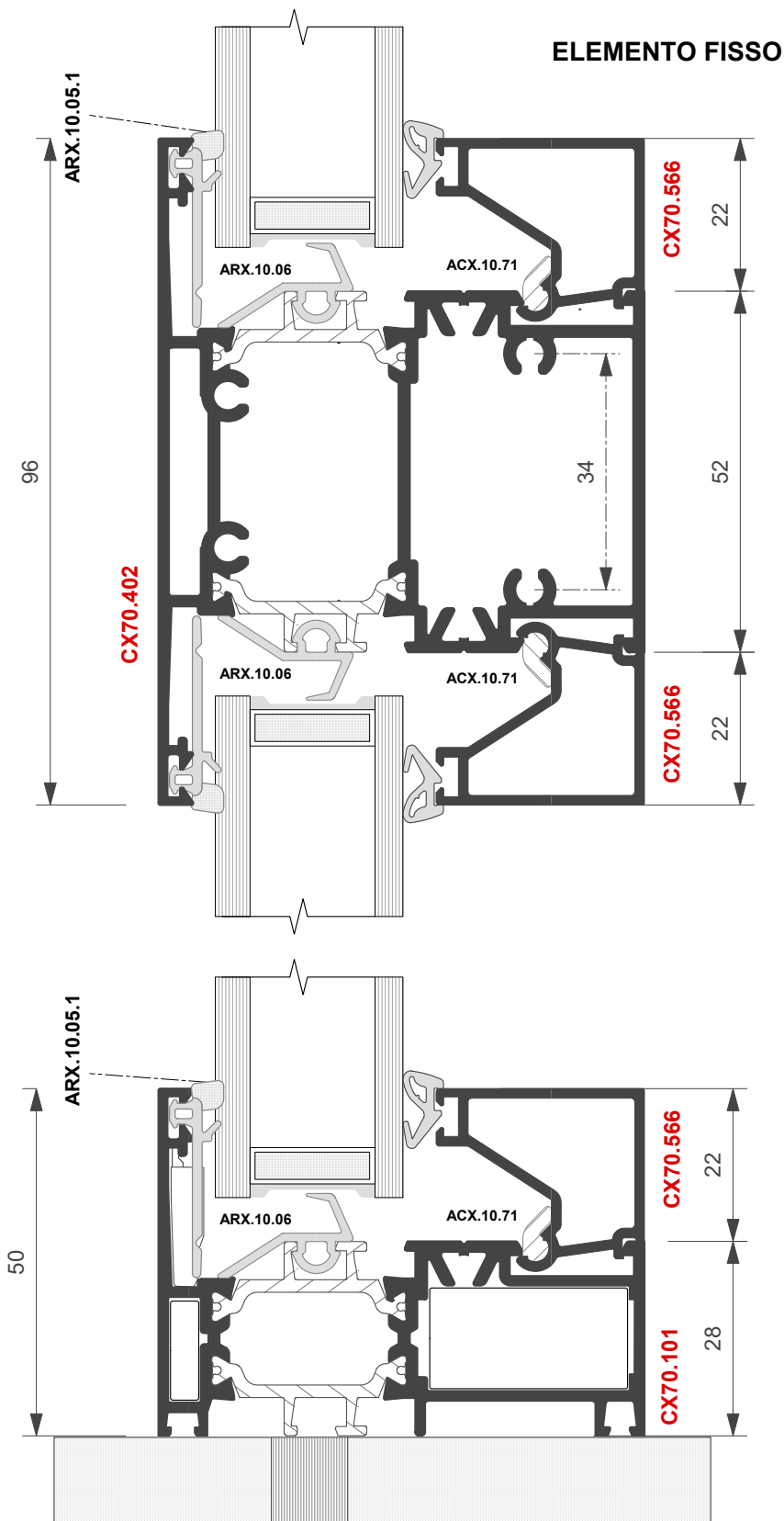



# Ferramenta a nastro

## FINESTRA A DUE ANTE

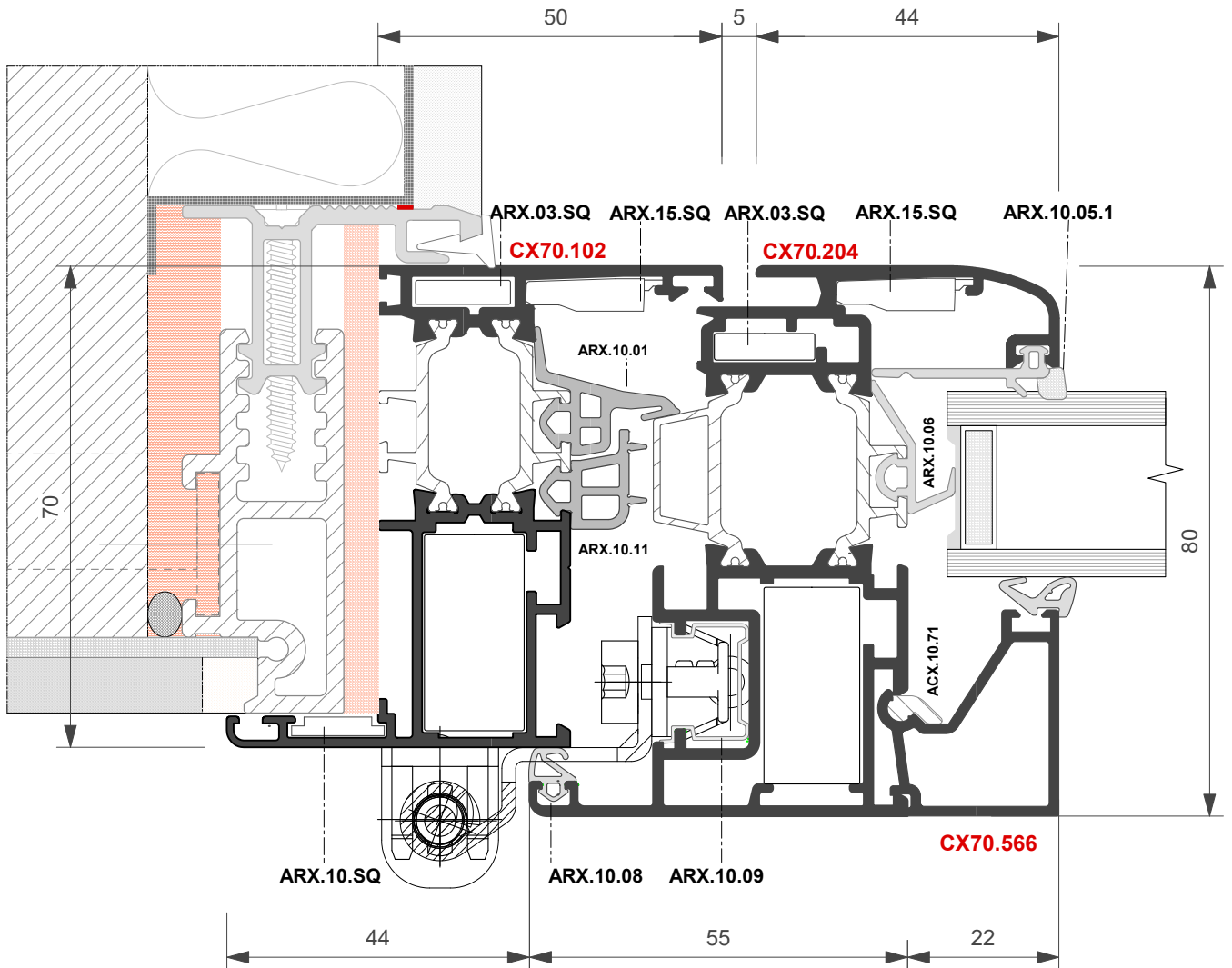
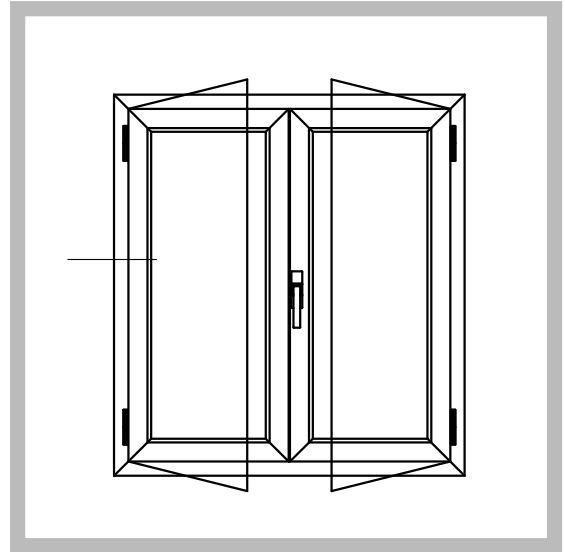



# Ferramenta a nastro

## FINESTRA A DUE ANTE

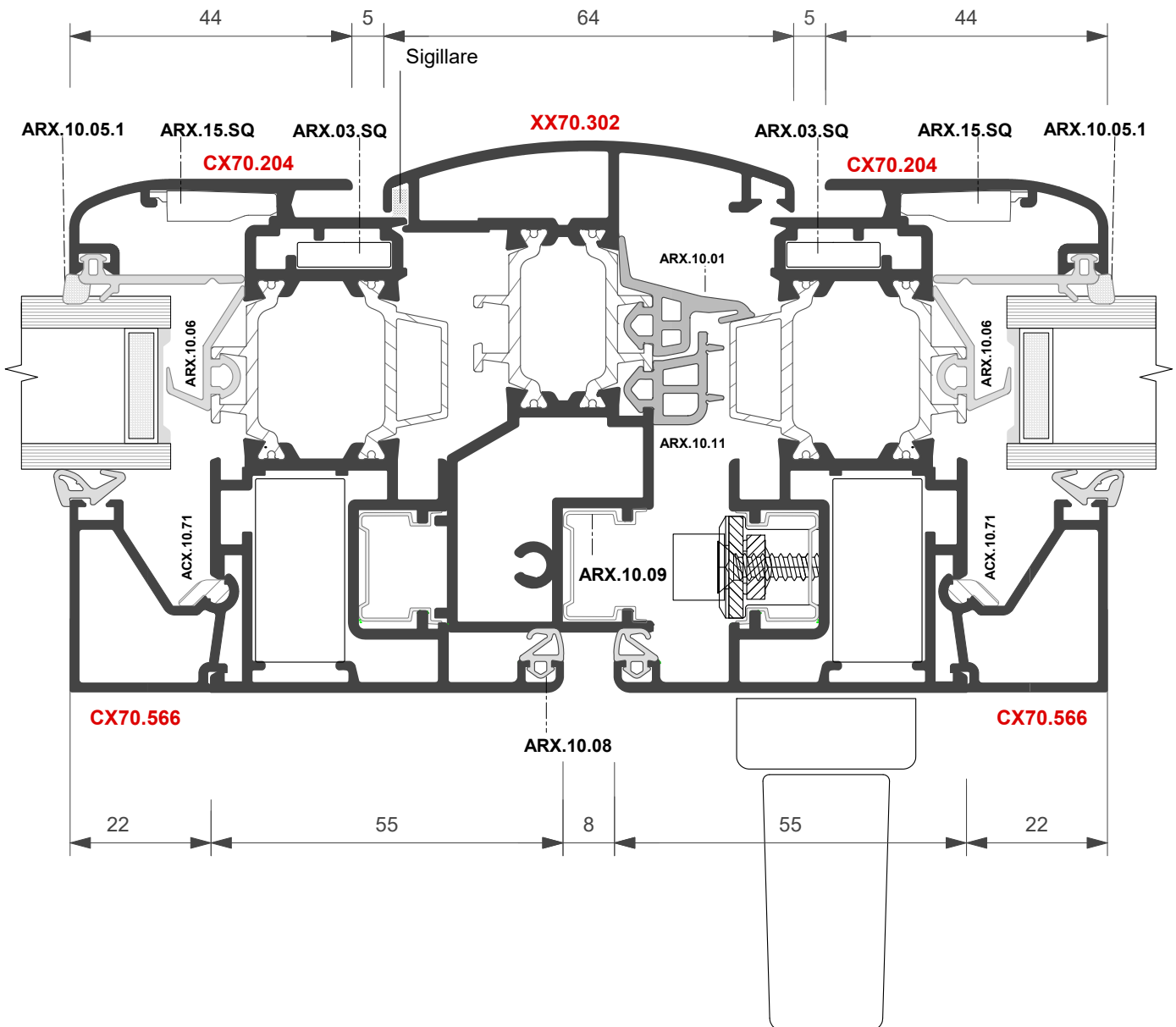
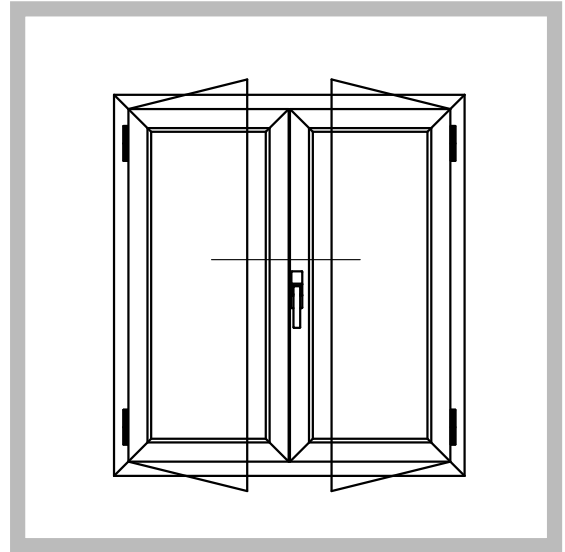



**FINESTRA A DUE ANTE**  
Scorrevole in parallelo

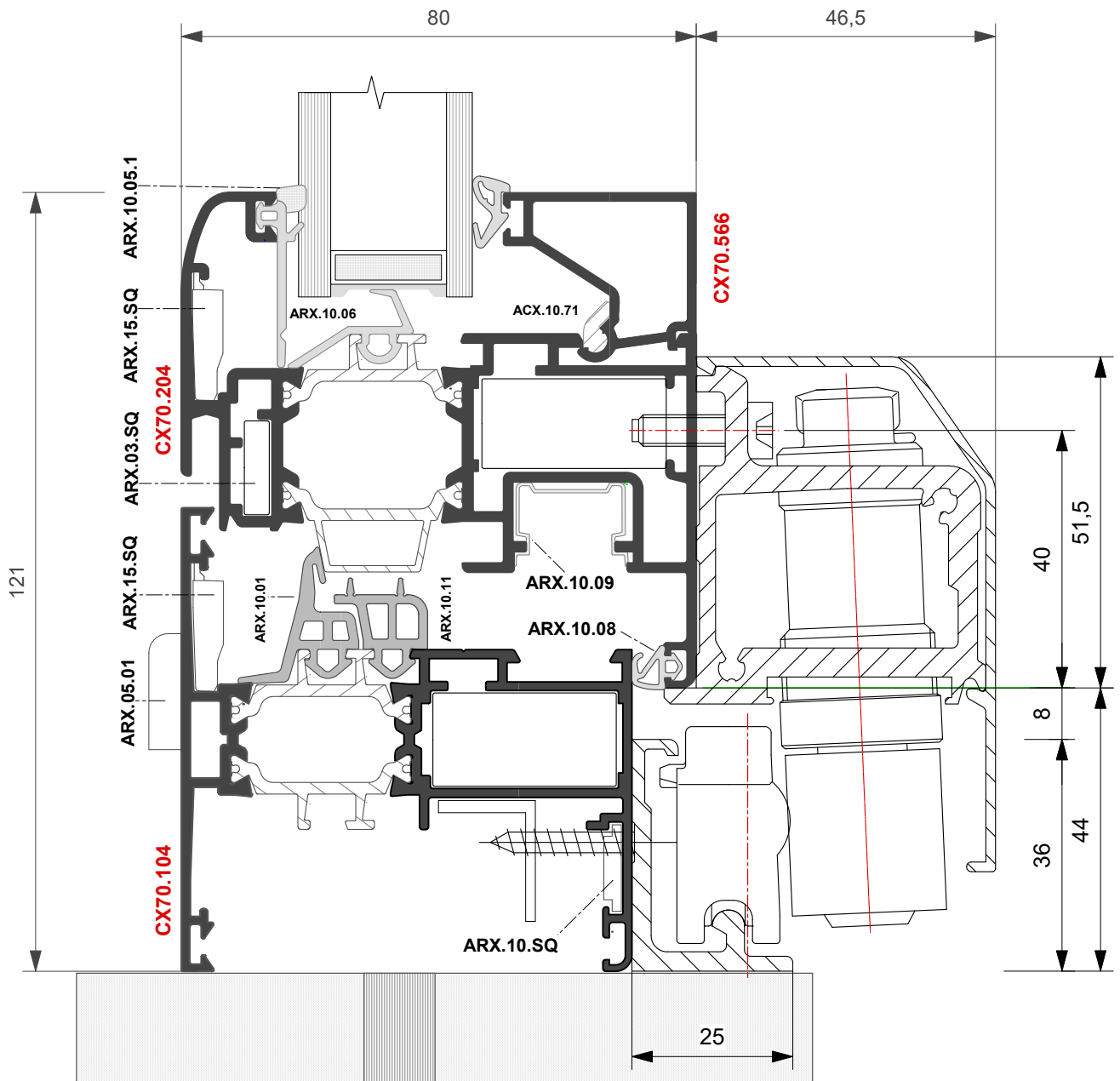
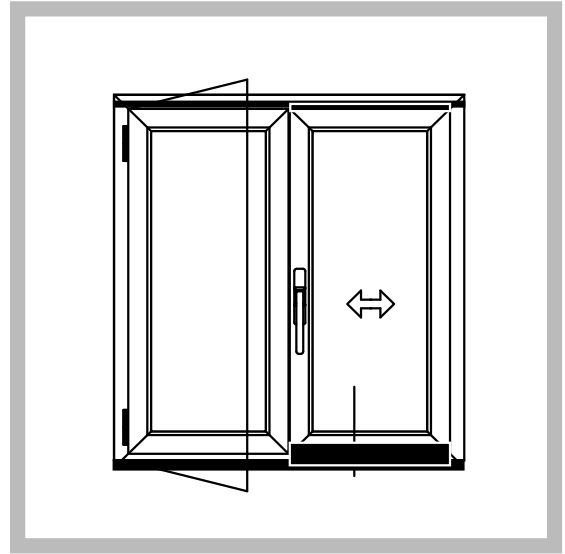





## Ferramenta a nastro

**FINESTRA A DUE ANTE**  
Scorrevole in parallelo

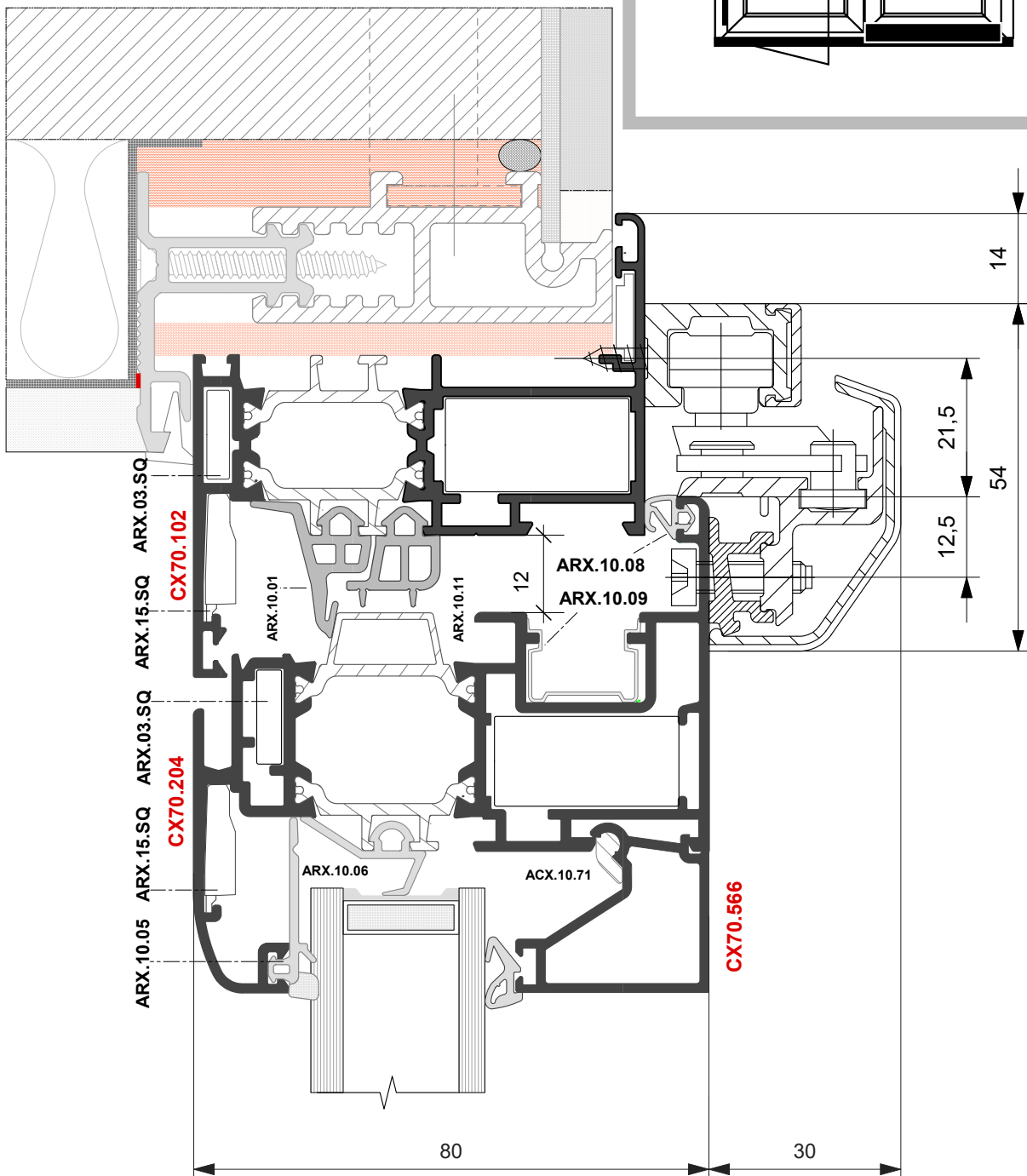
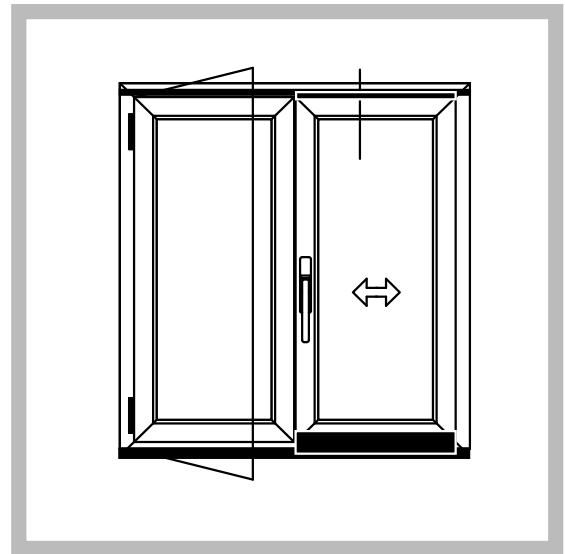



## Ferramenta a nastro

### PORTA BALCONE A DUE ANTE

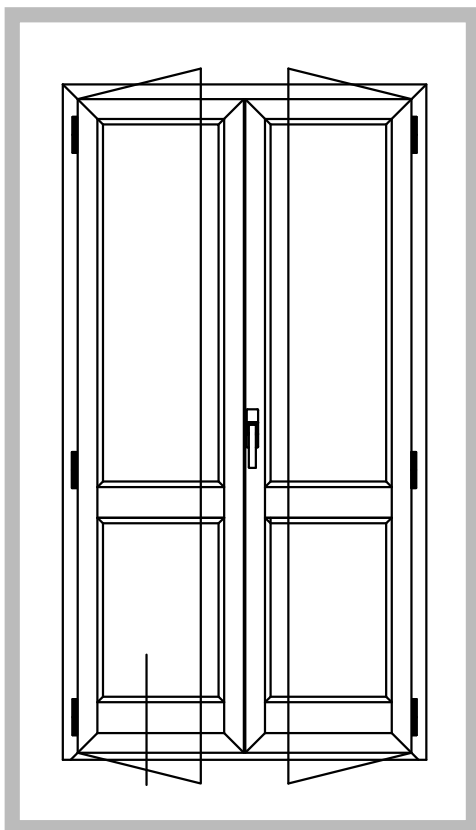
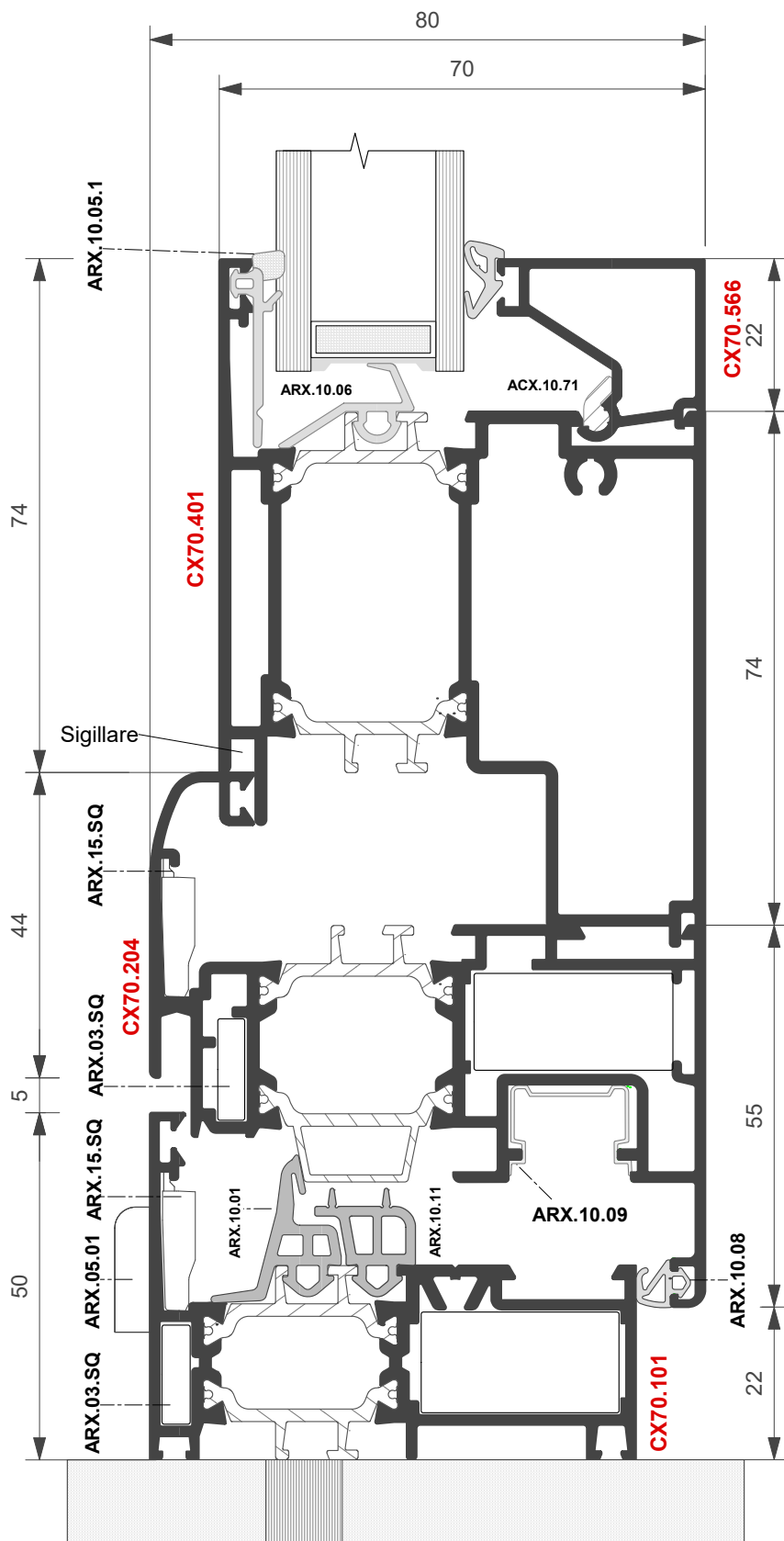



## Ferramenta a nastro

### PORTA BALCONE A DUE ANTE

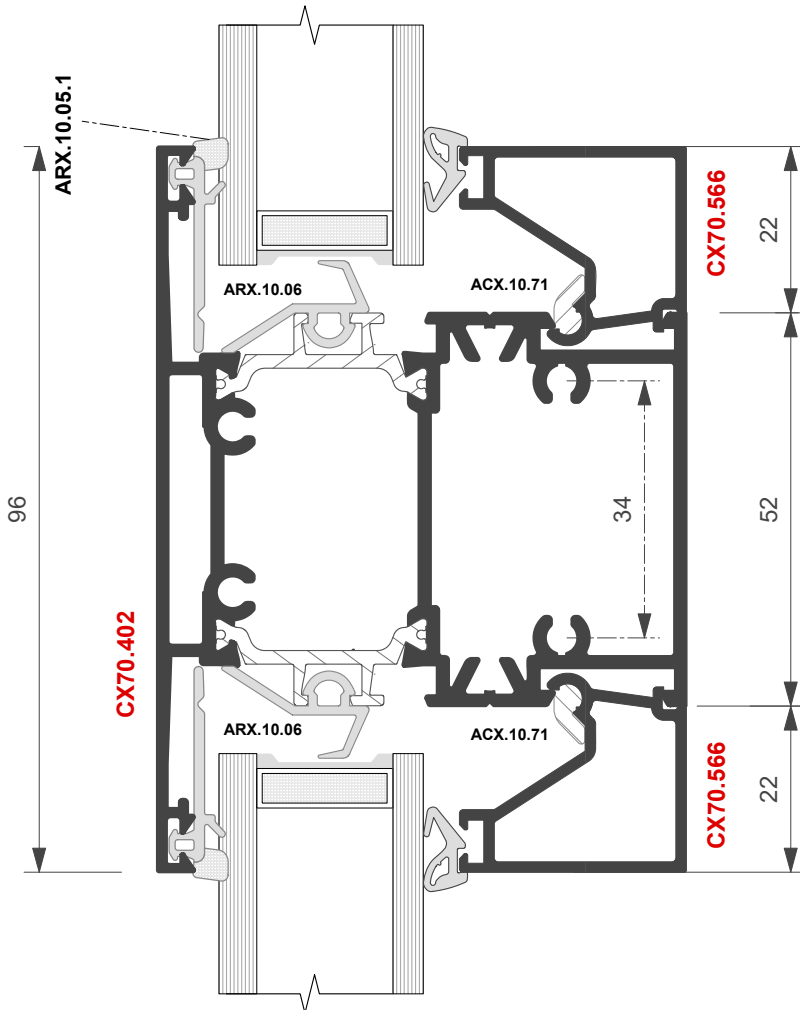
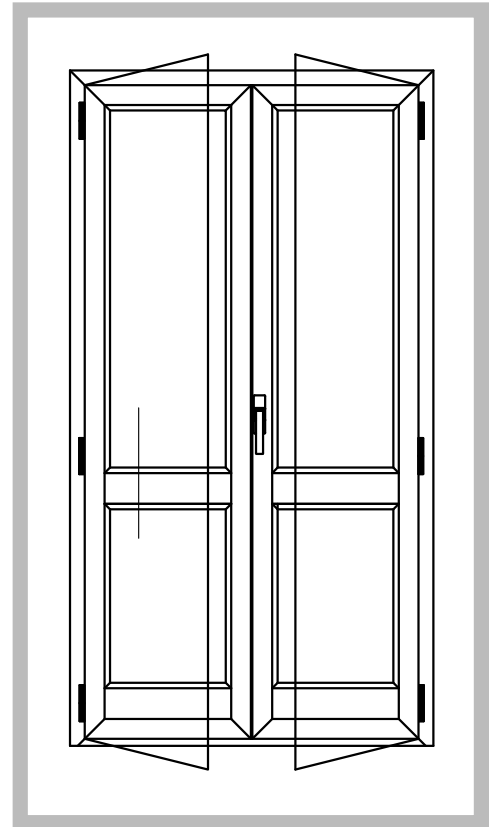



**FINESTRA  
BILICO ORIZZONTALE**

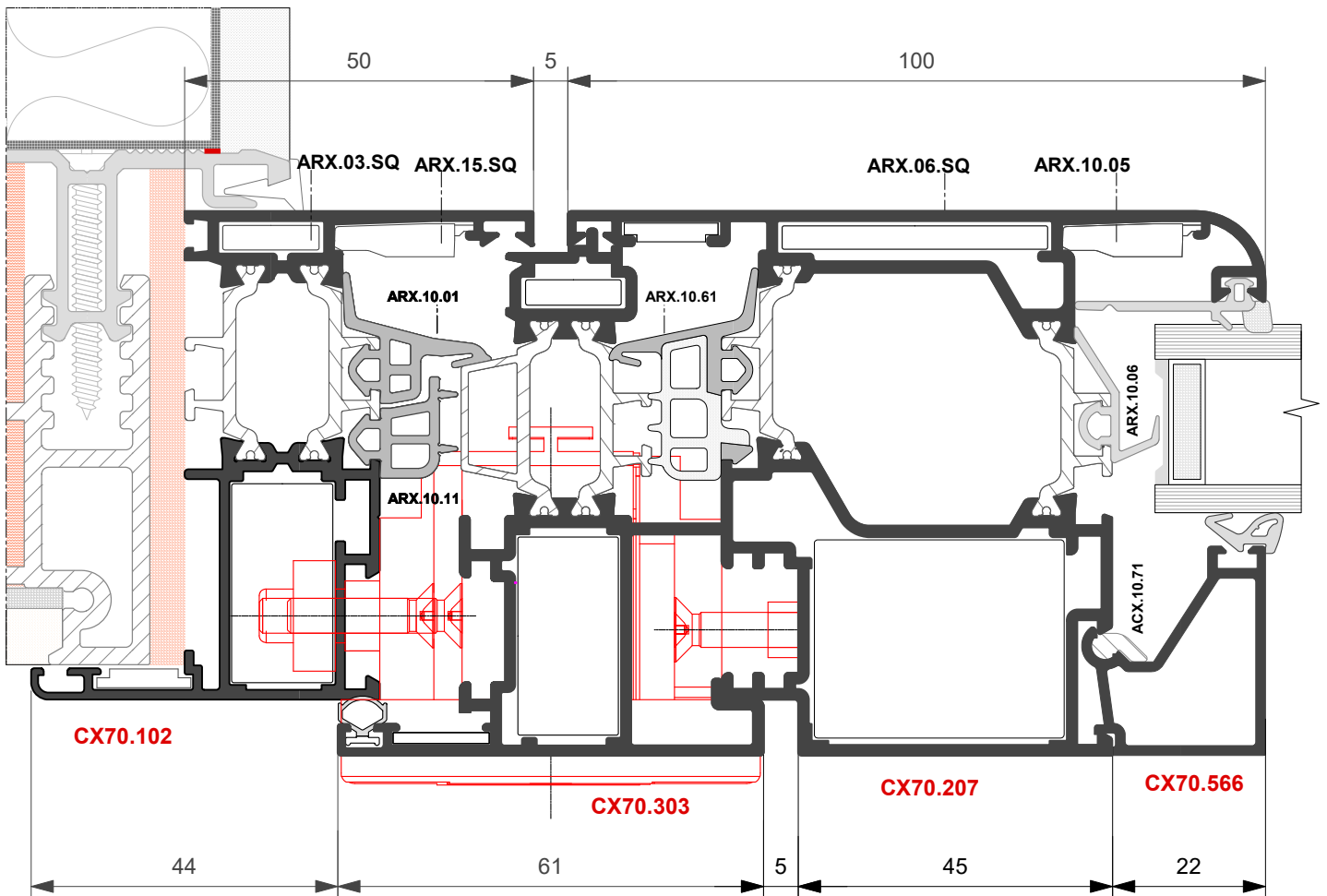
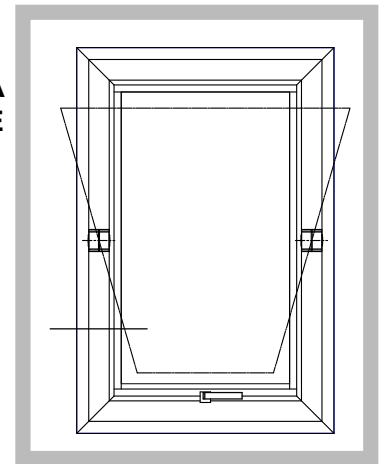

Accessorio Frizione **GU Italia U - 18/3**

**Articolo 6 - 27212 - 07 - P**

per accessori di movimentazione riferirsi  
alla tavola di assieme



**ABBINAMENTO CON SCORREVOLE SX 700**

Telaio in appoggio

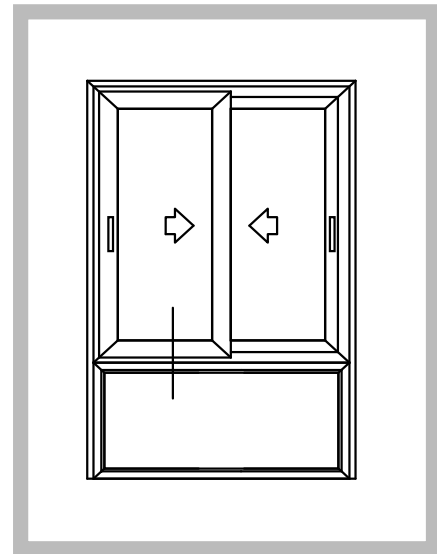
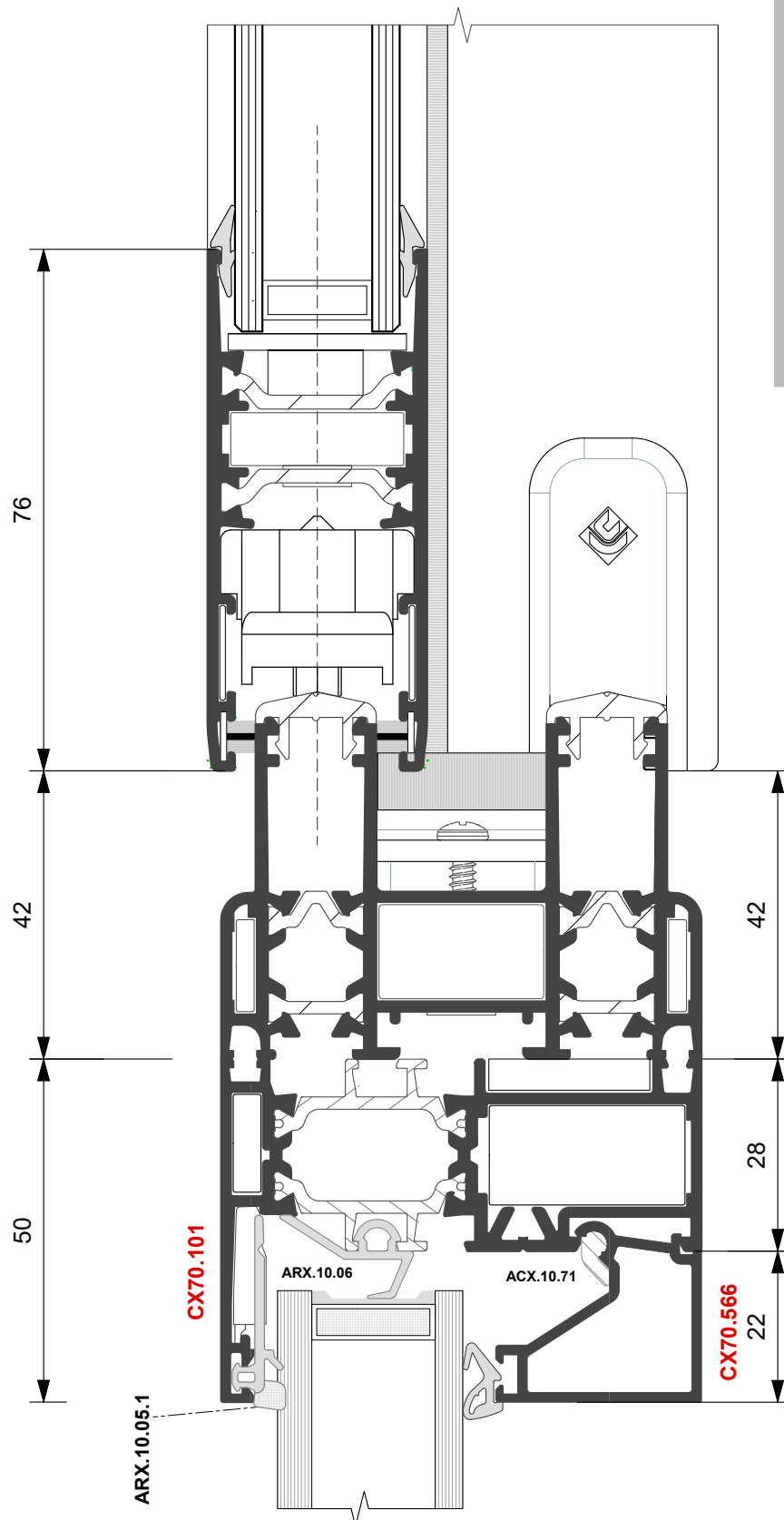

Per i riferimenti della serie SX 700 consultare il relativo catalogo.



**TELAIO CAPANNONI**

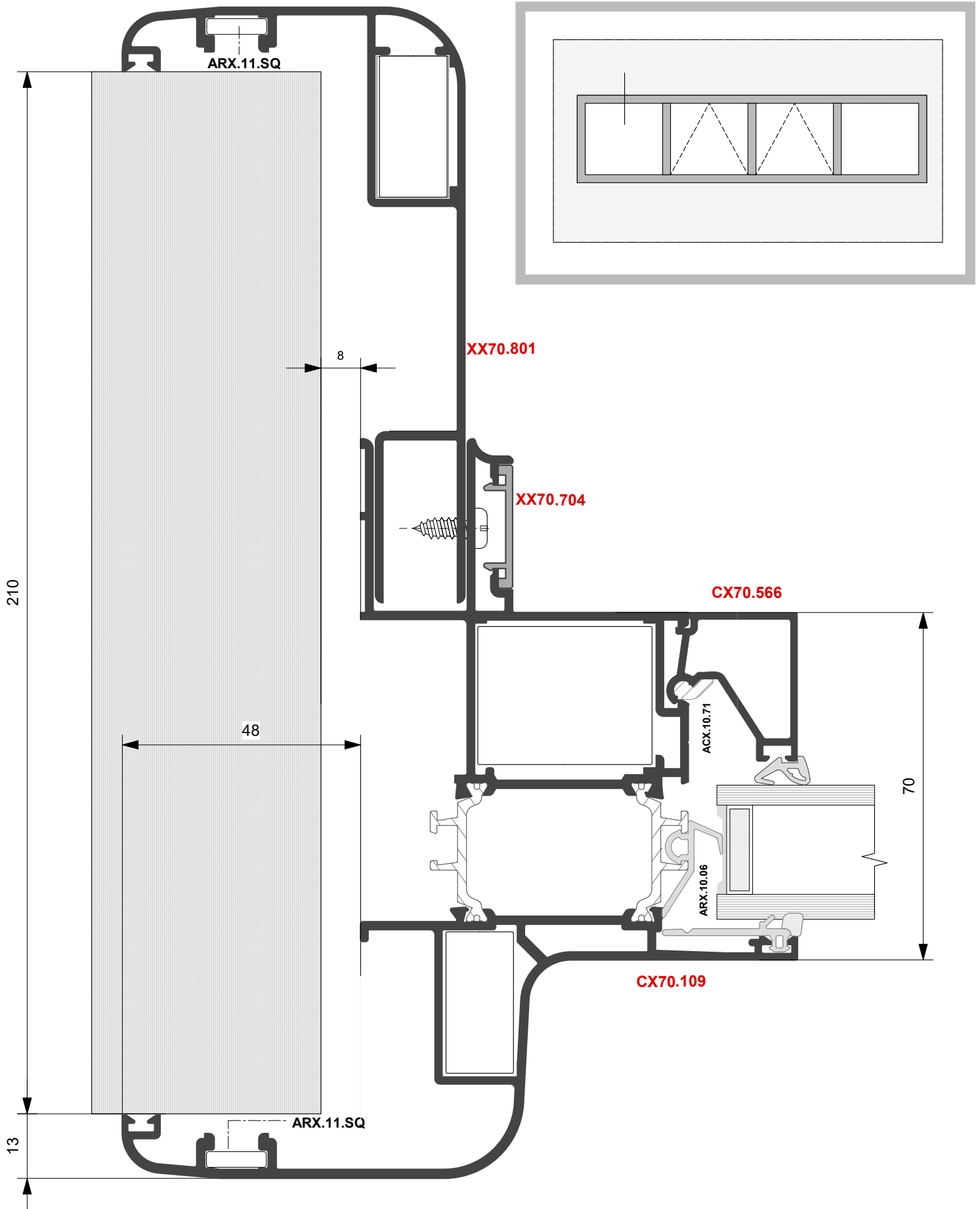



**TELAIO CAPANNONI**

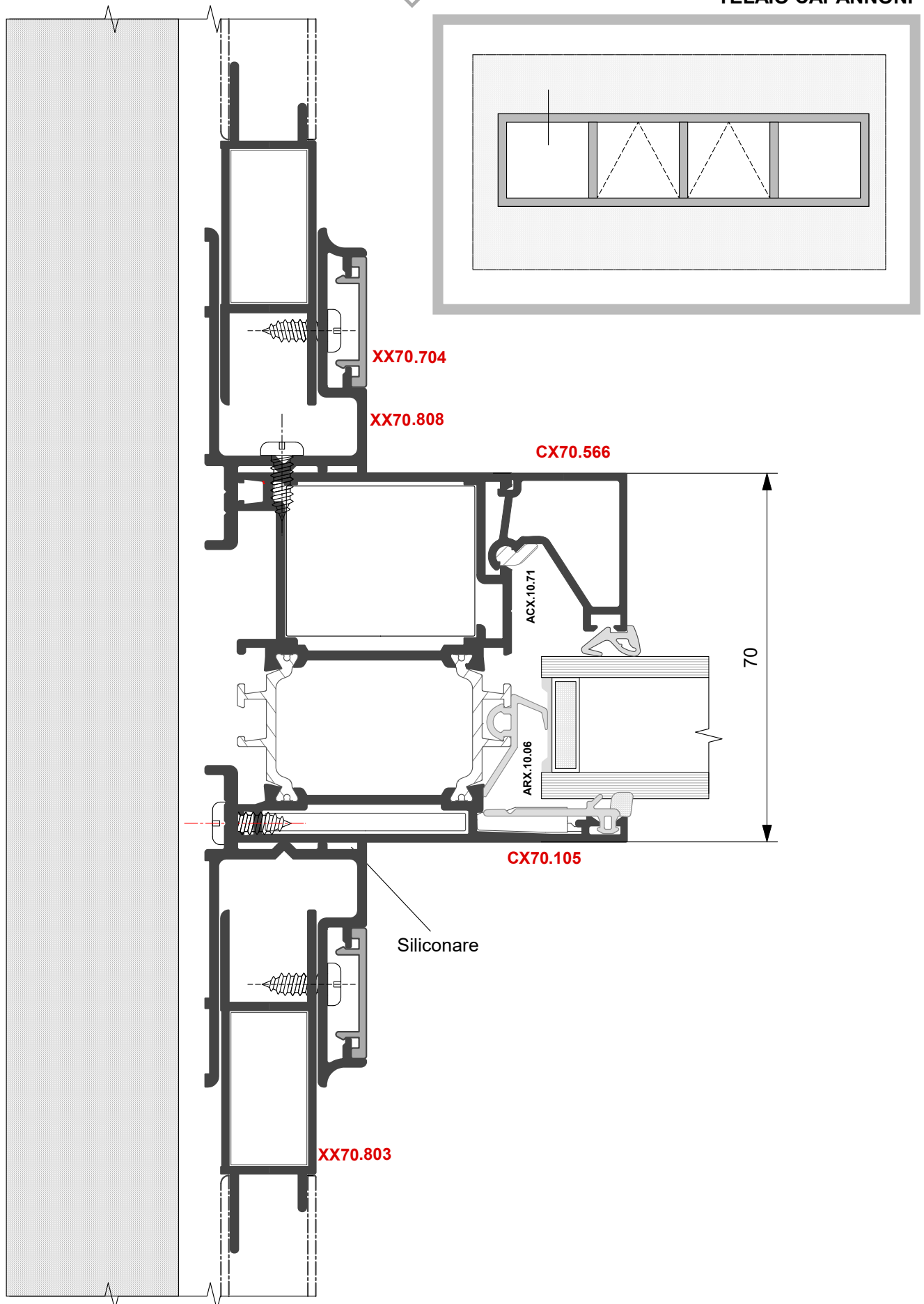



**TELAI COMPENSAZIONE**

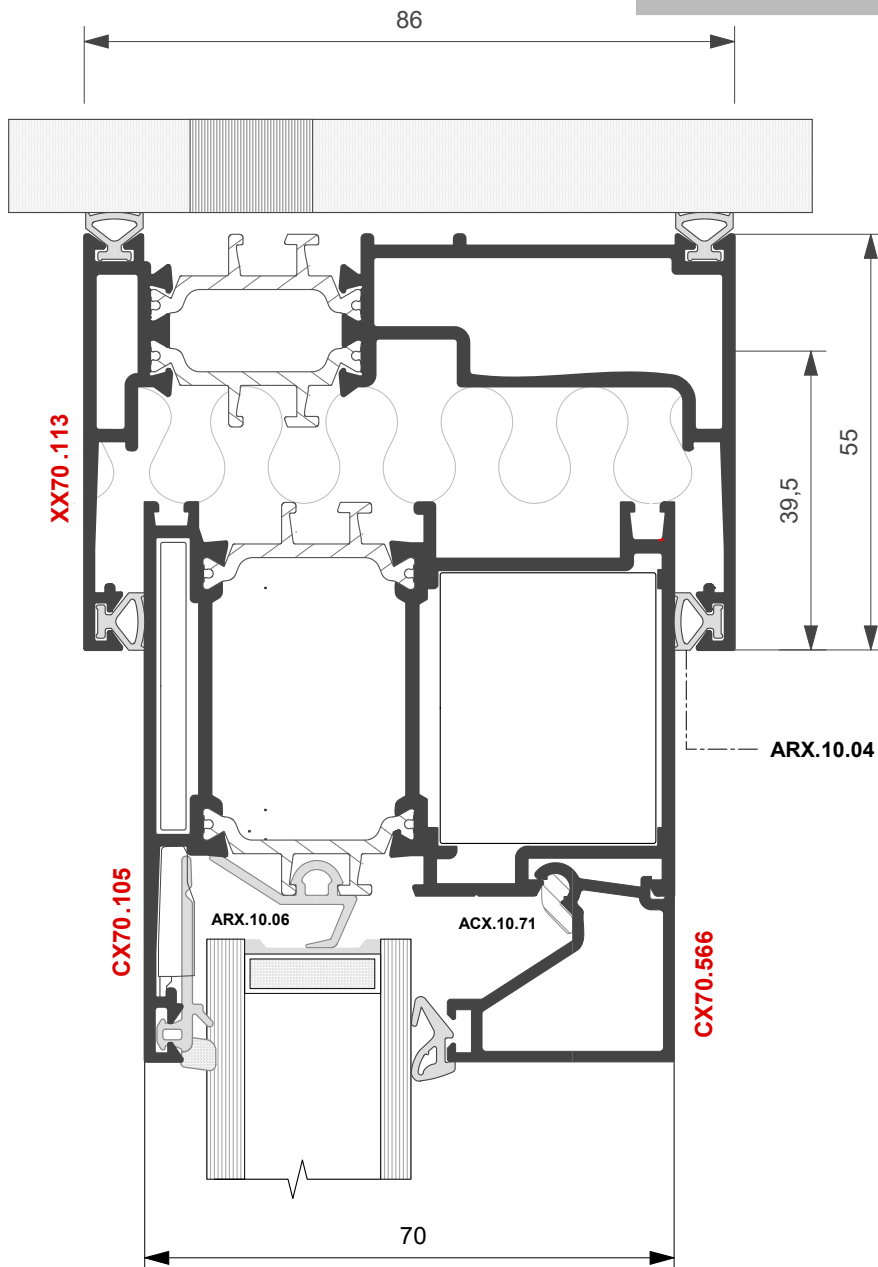
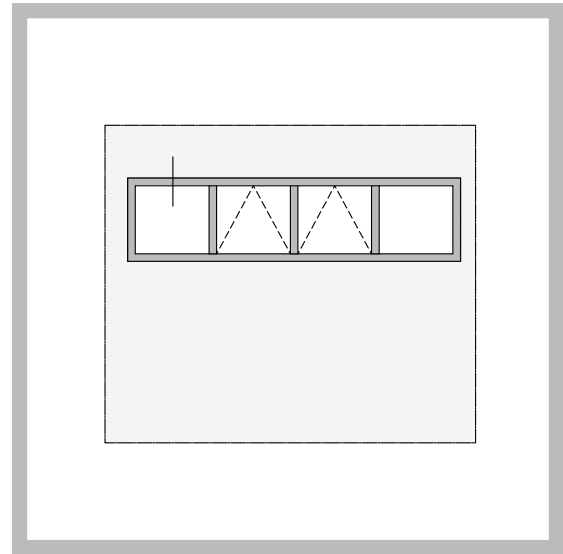





**PROFILO UNIVERSALE PER ANGOLO A 90°**

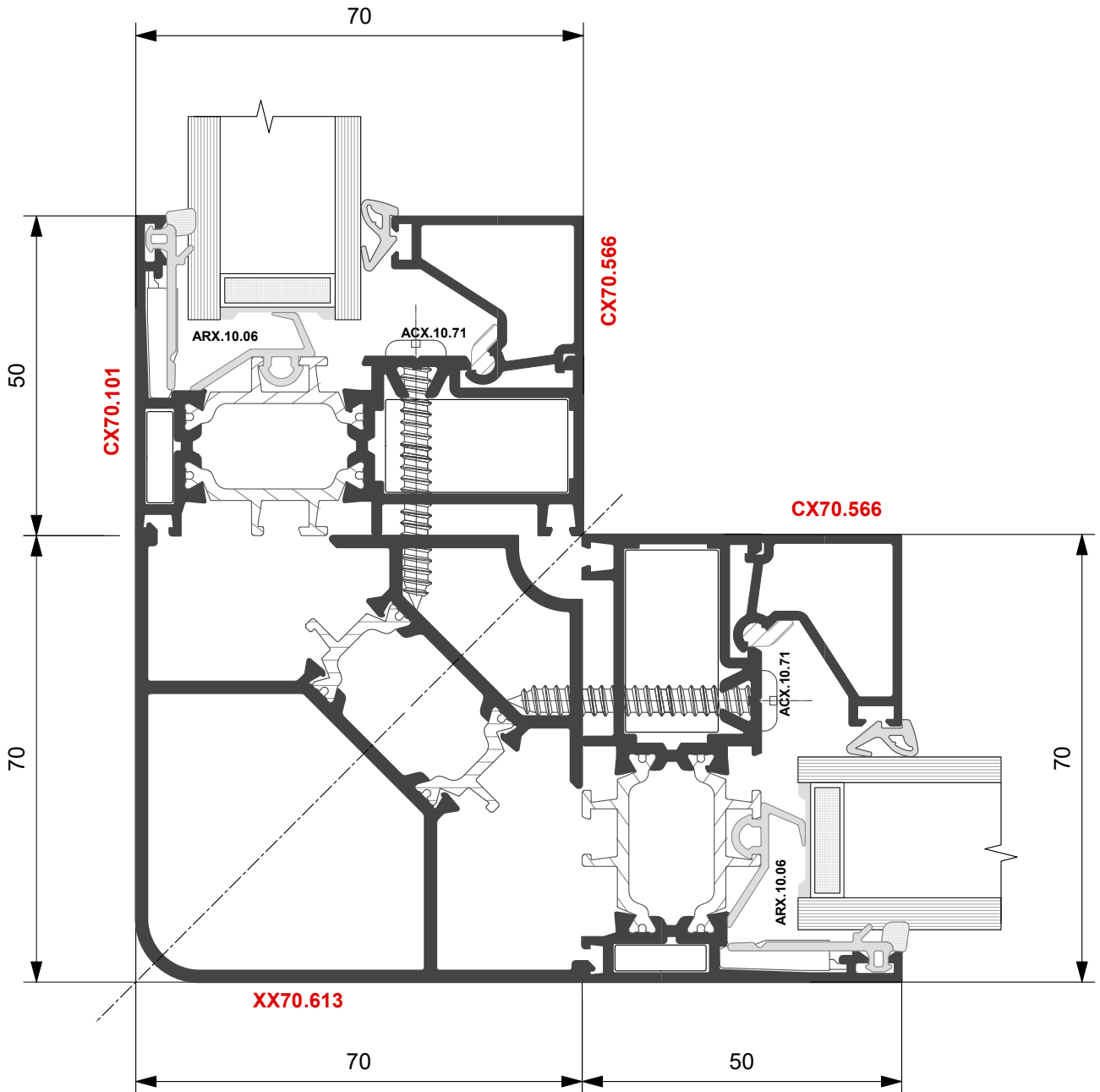



**PORTA DI INGRESSO A 2 ANTE**

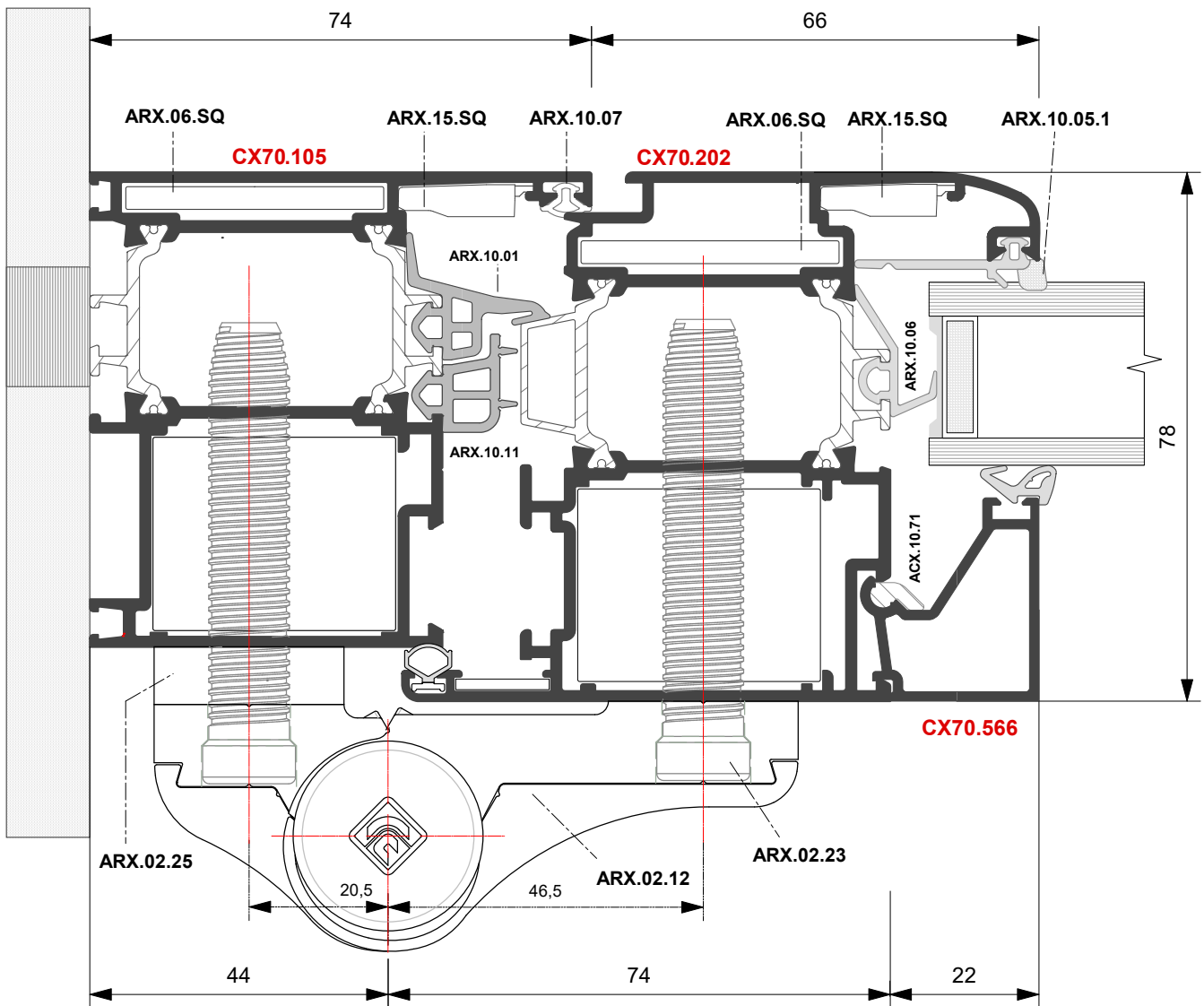
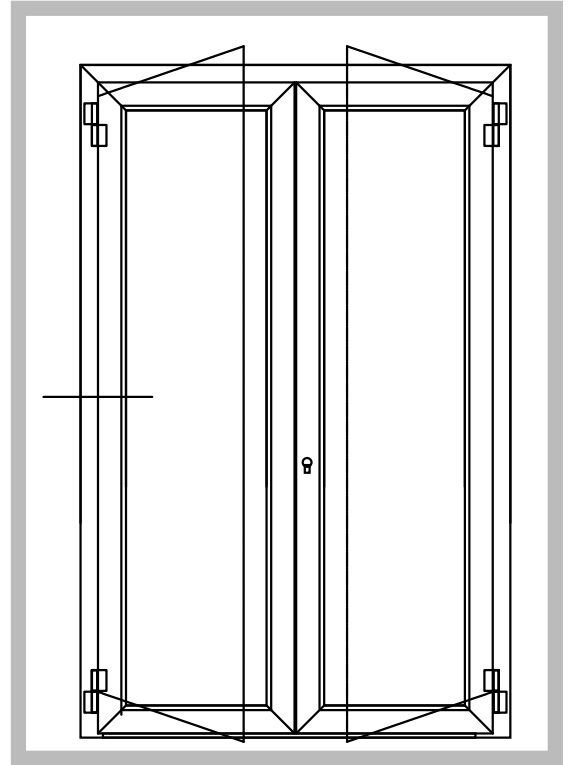



**PORTA DI INGRESSO A 2 ANTE**

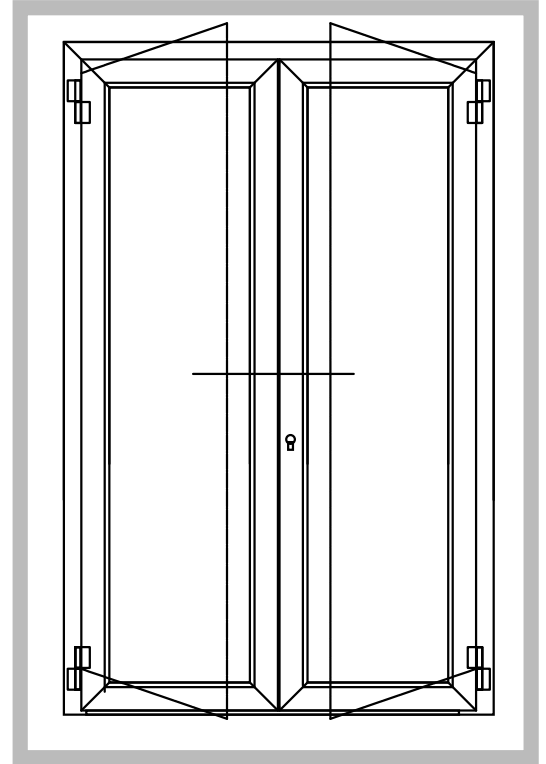
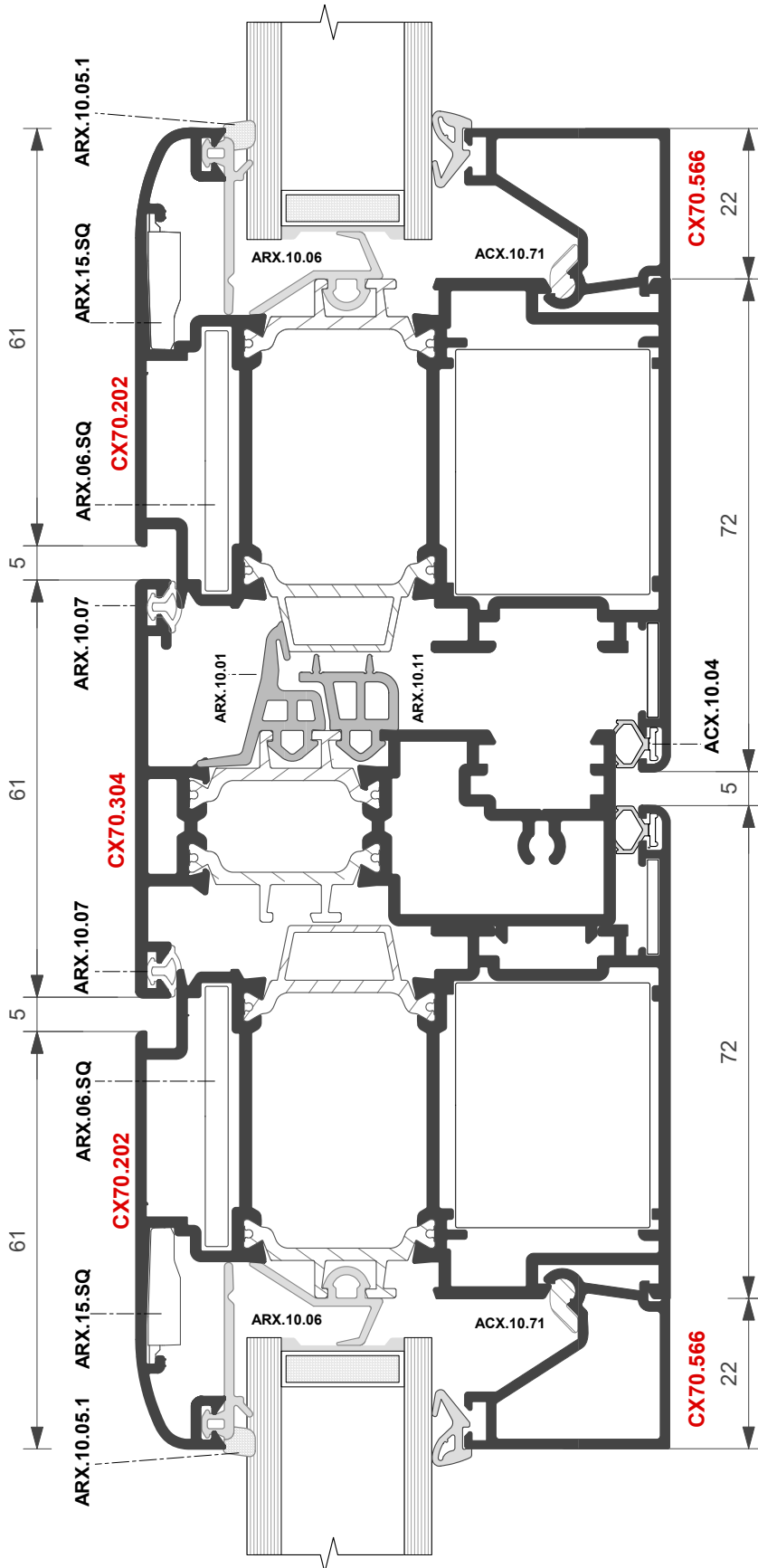



**PORTA INGRESSO AD UNA ANTA**

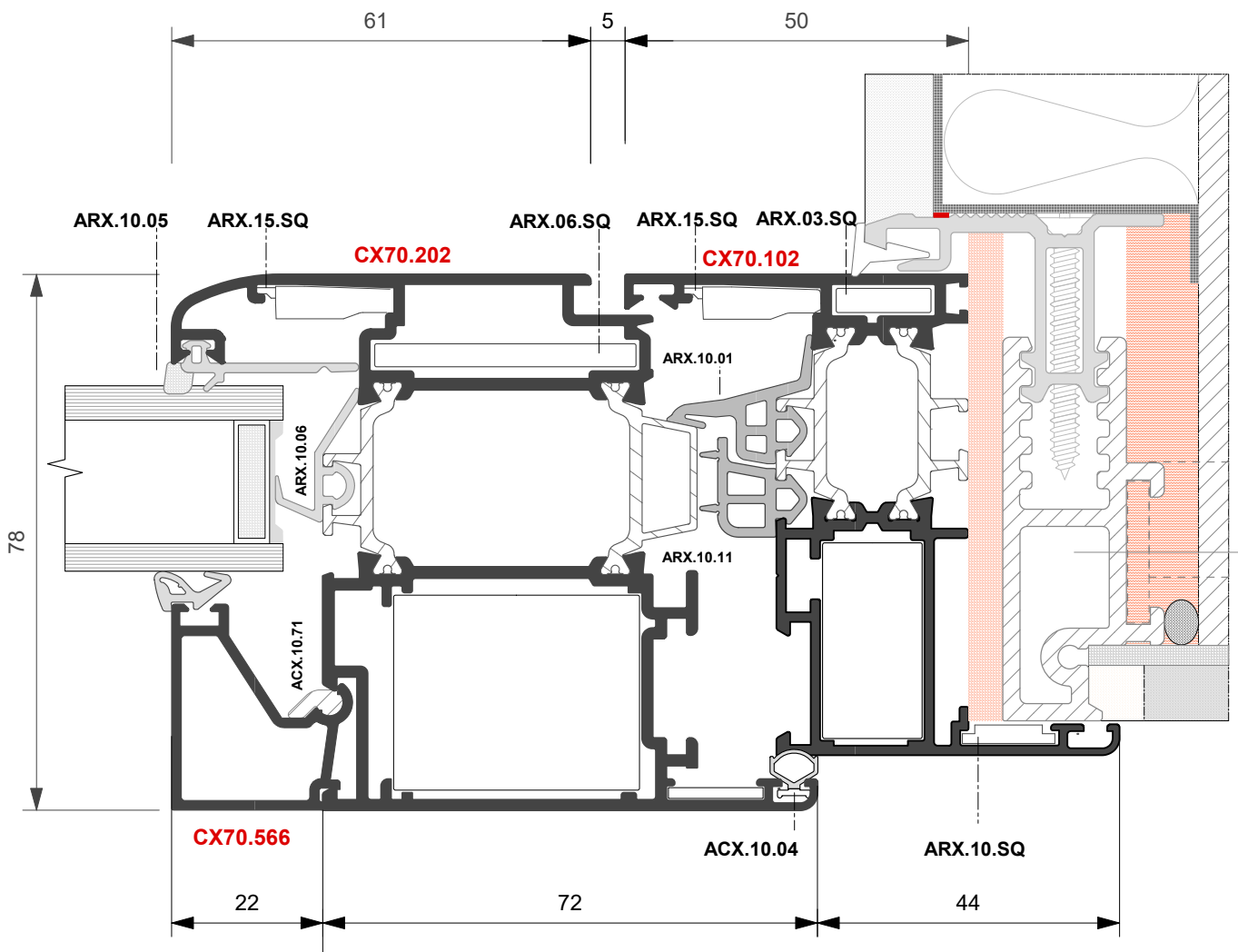
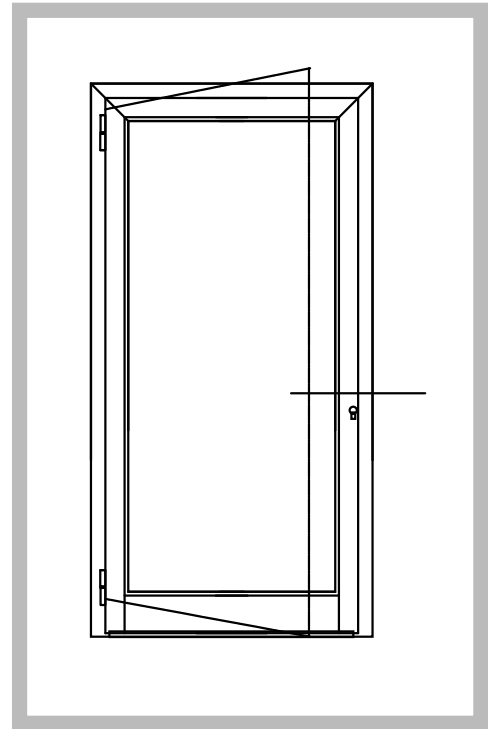



**PORTA DI INGRESSO A 2 ANTE**

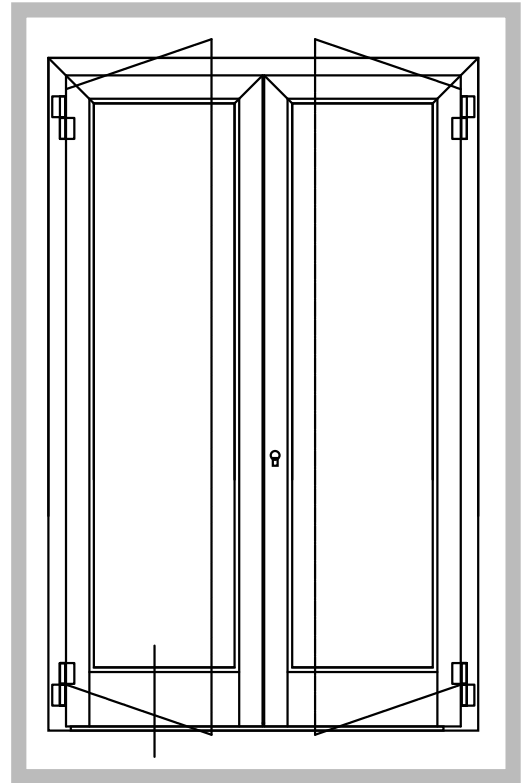
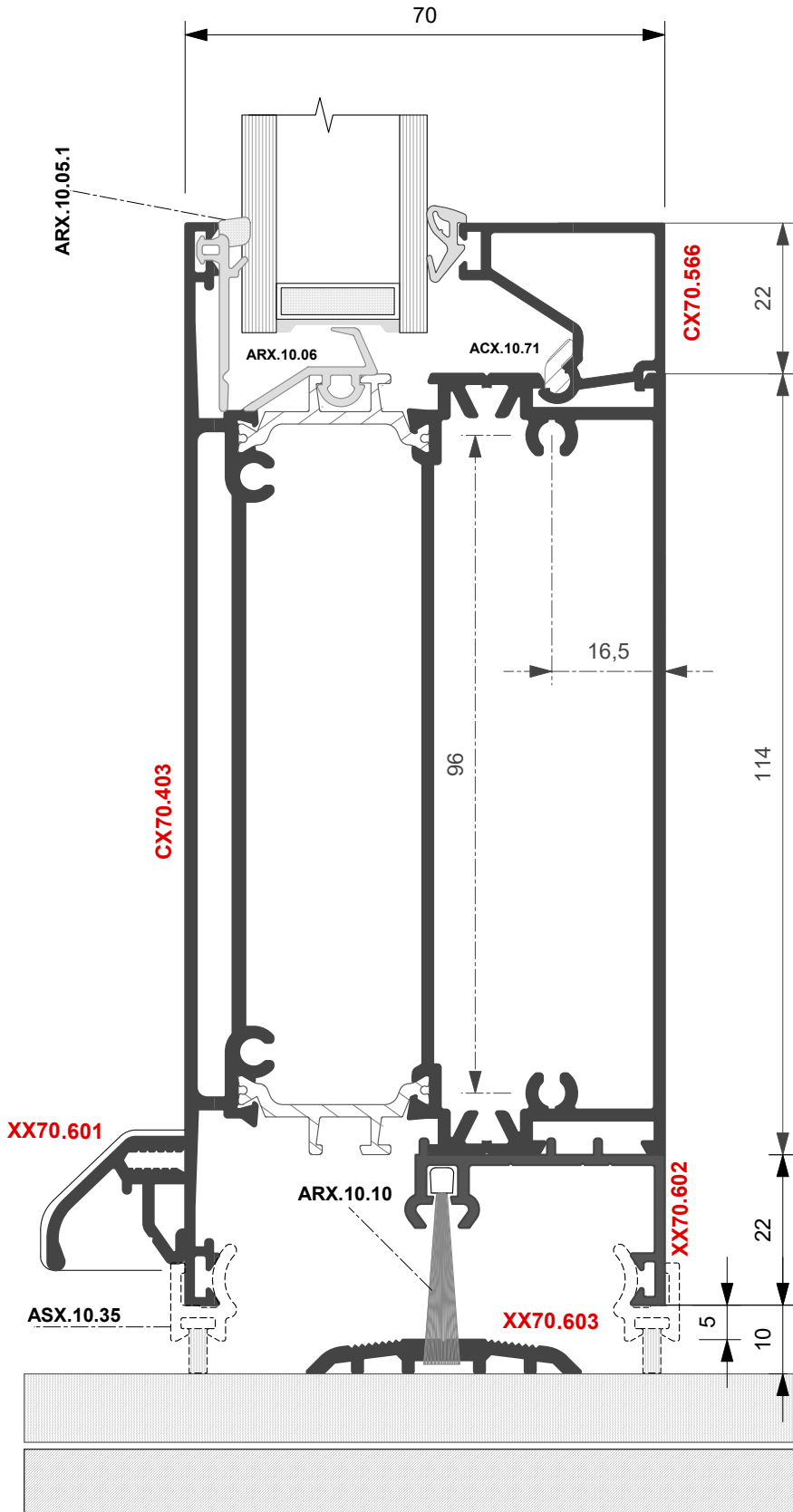



**PORTA DI INGRESSO A 2 ANTE**

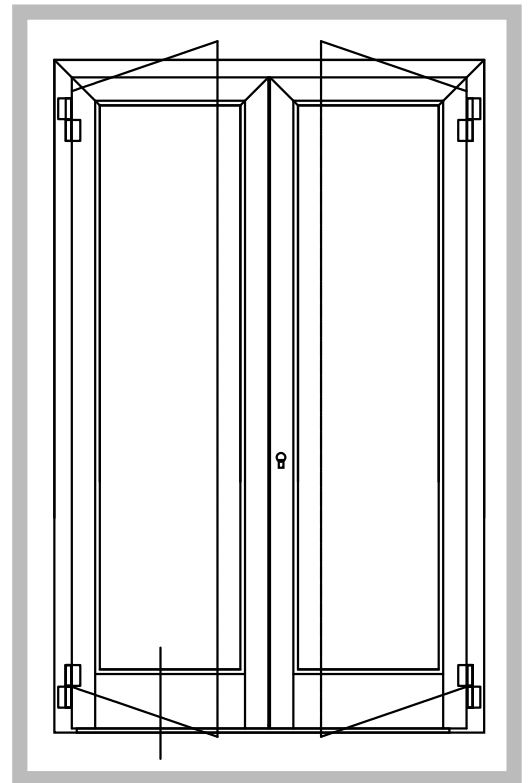
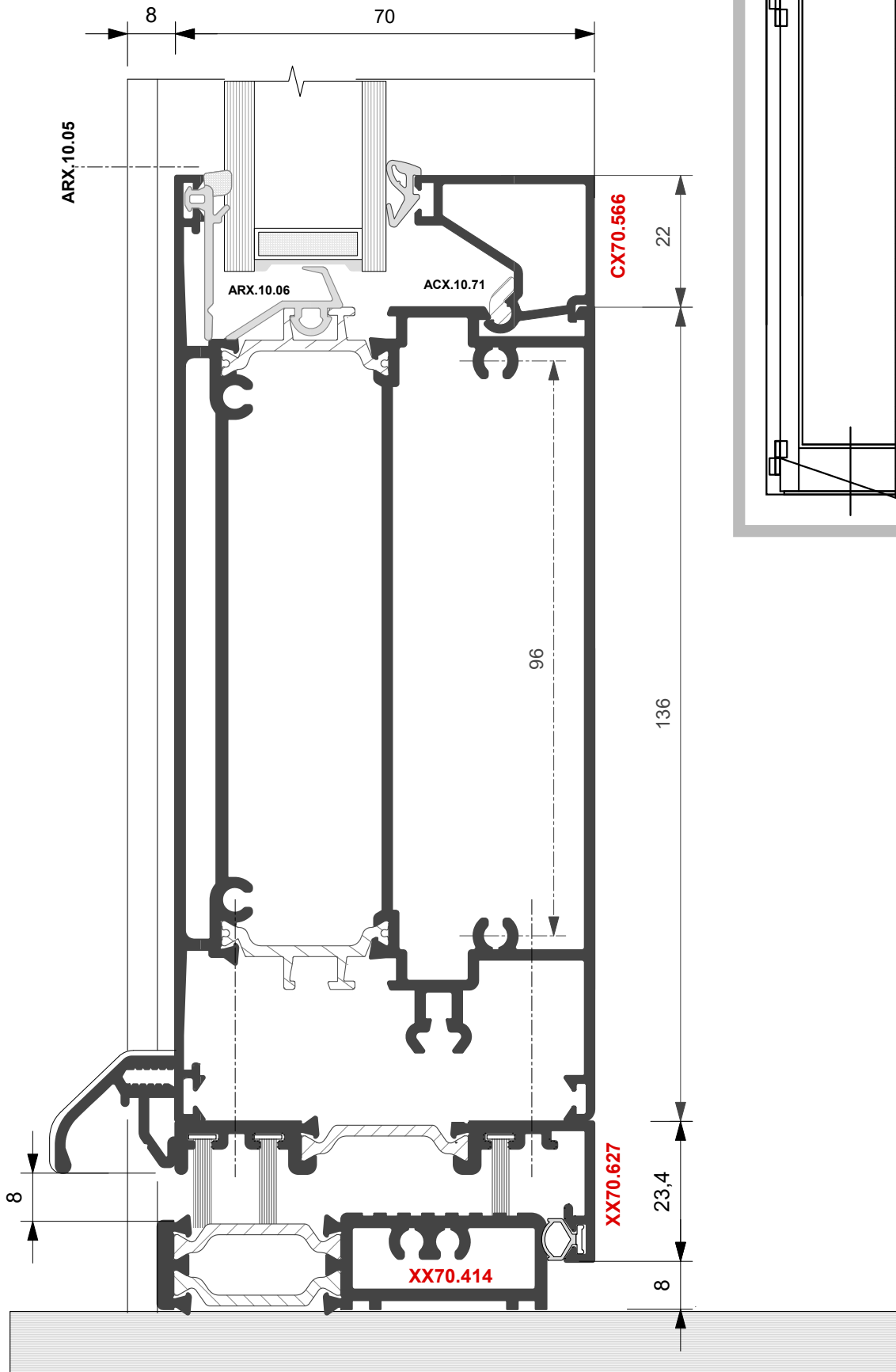

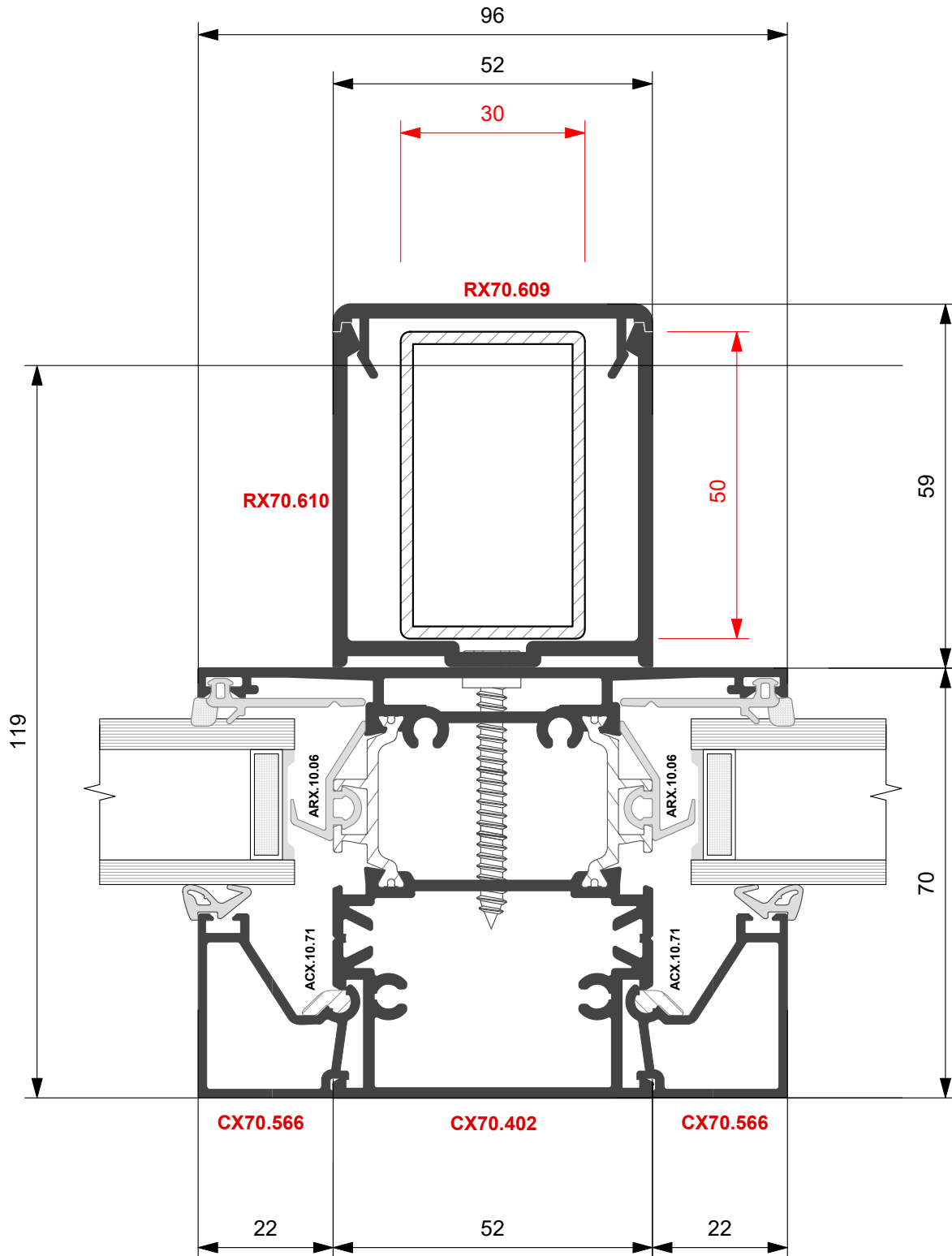

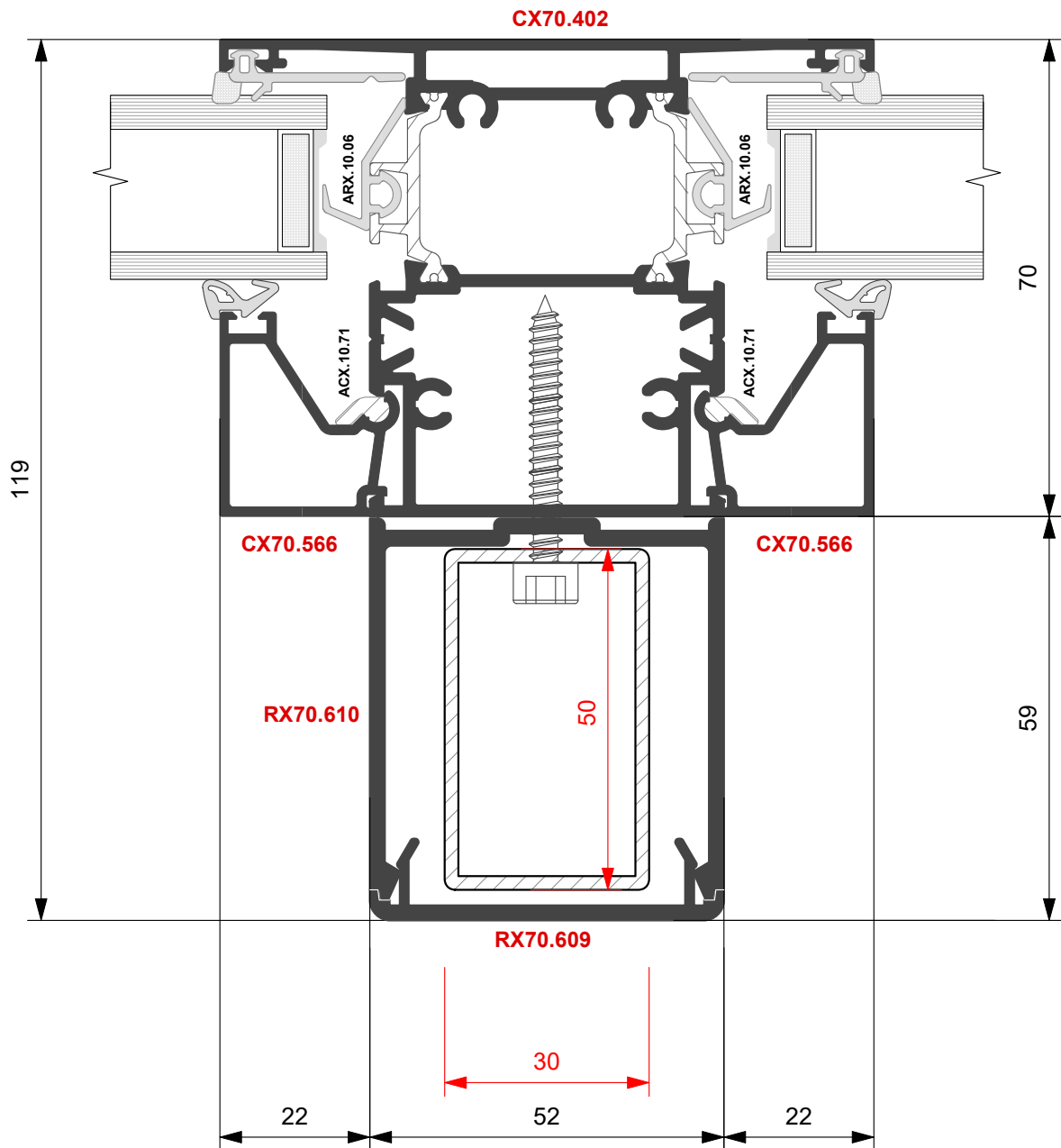



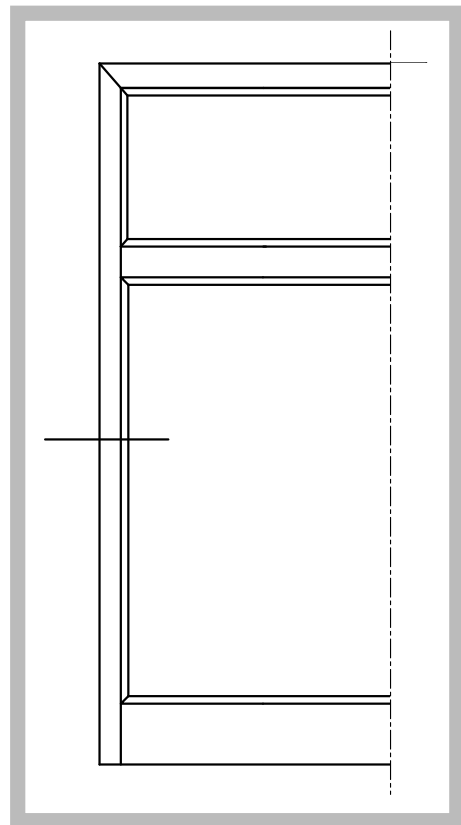
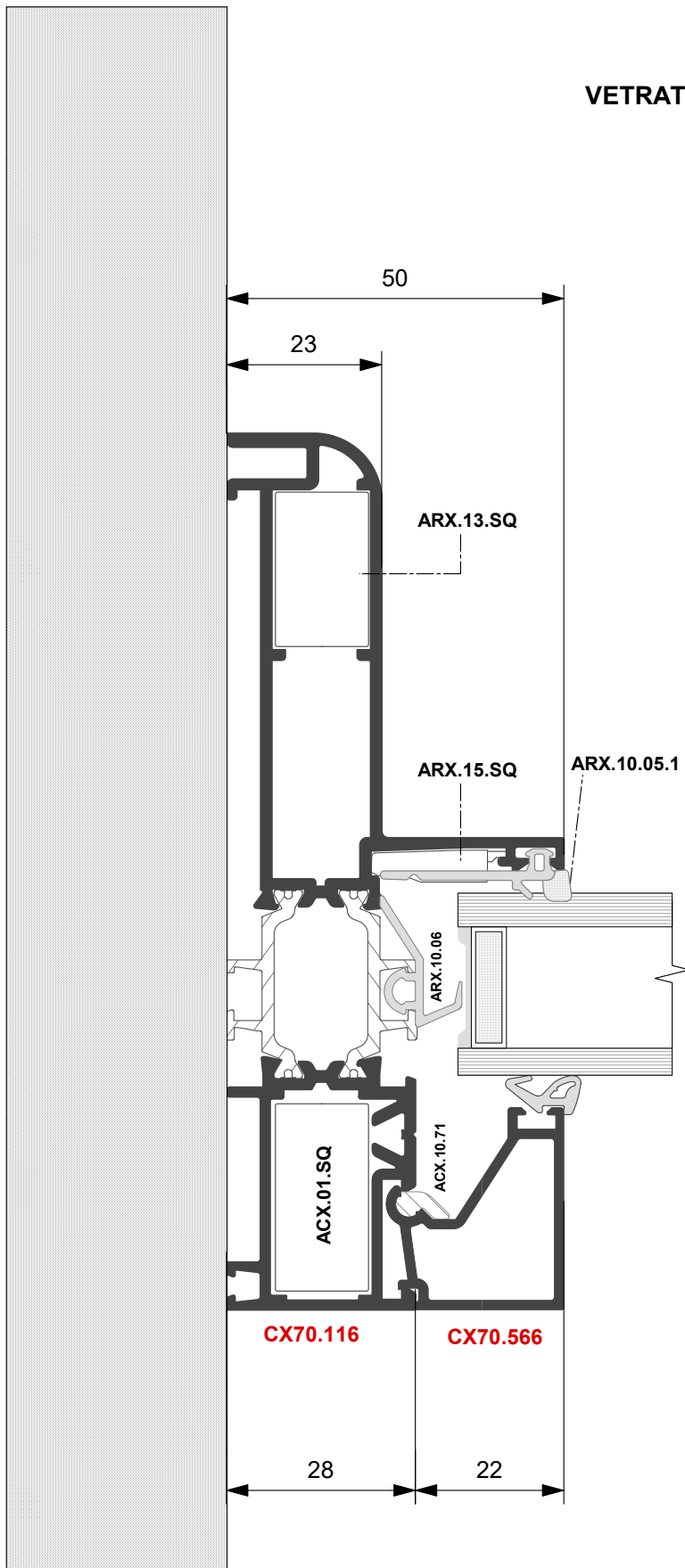



VETRATE

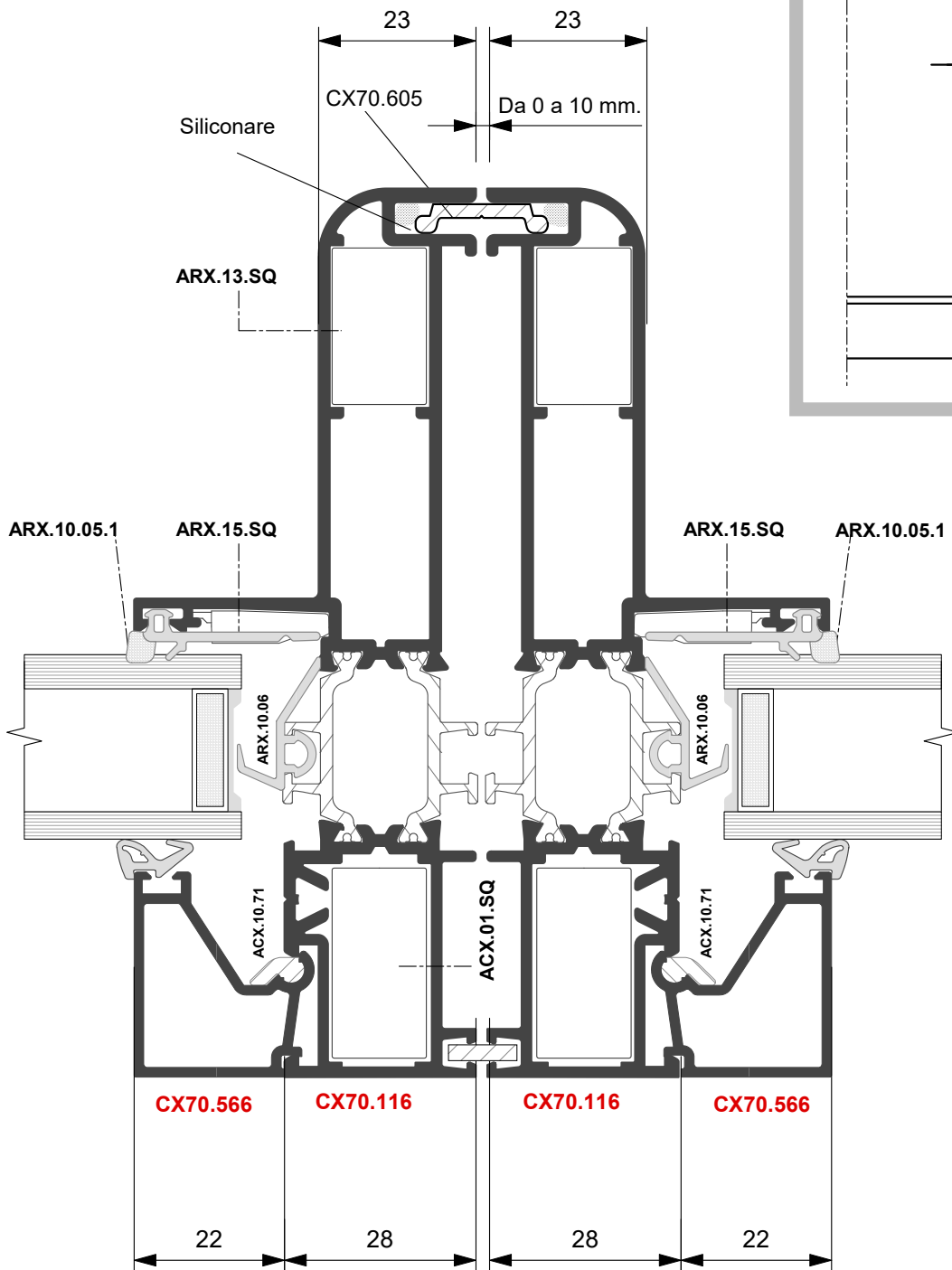



**PORTA DI INGRESSO A 2 ANTE**  
Apertura esterna

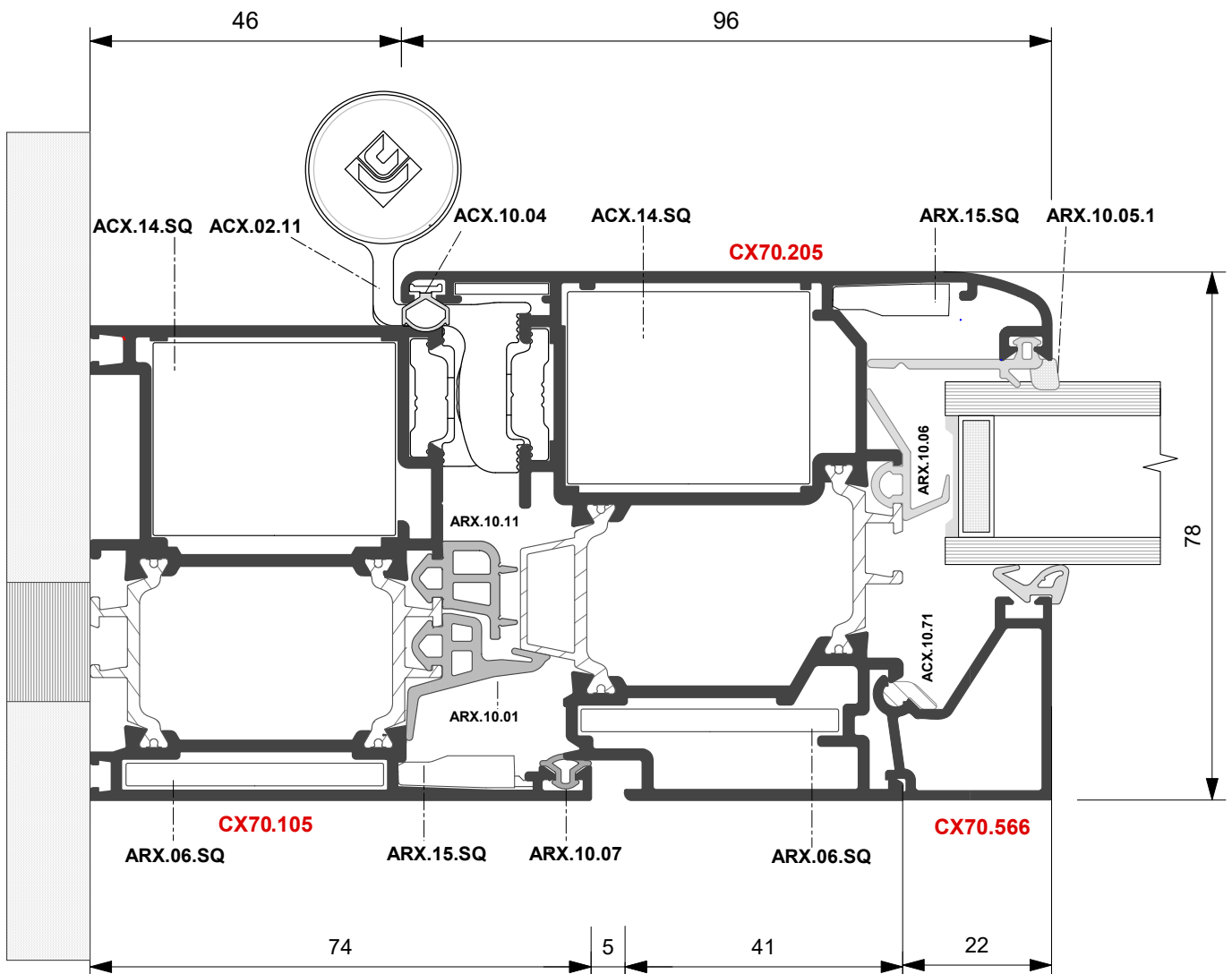
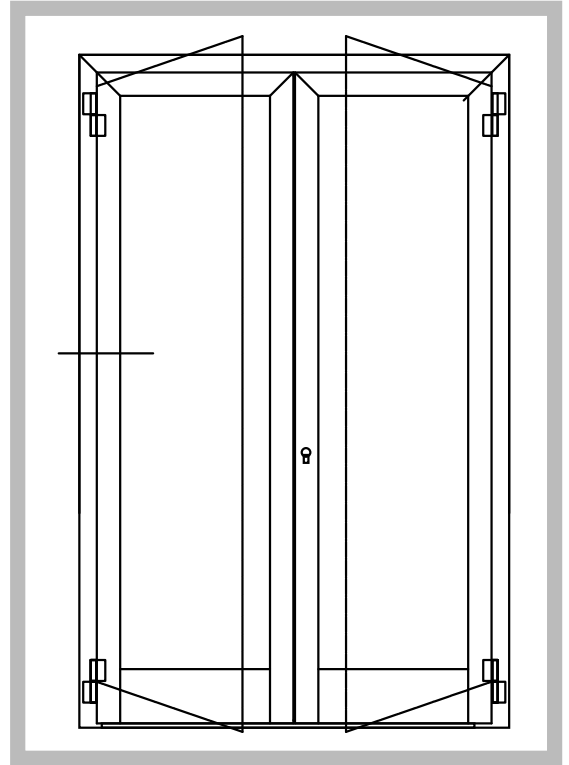



**PORTA DI INGRESSO A 2 ANTE**  
Apertura esterna

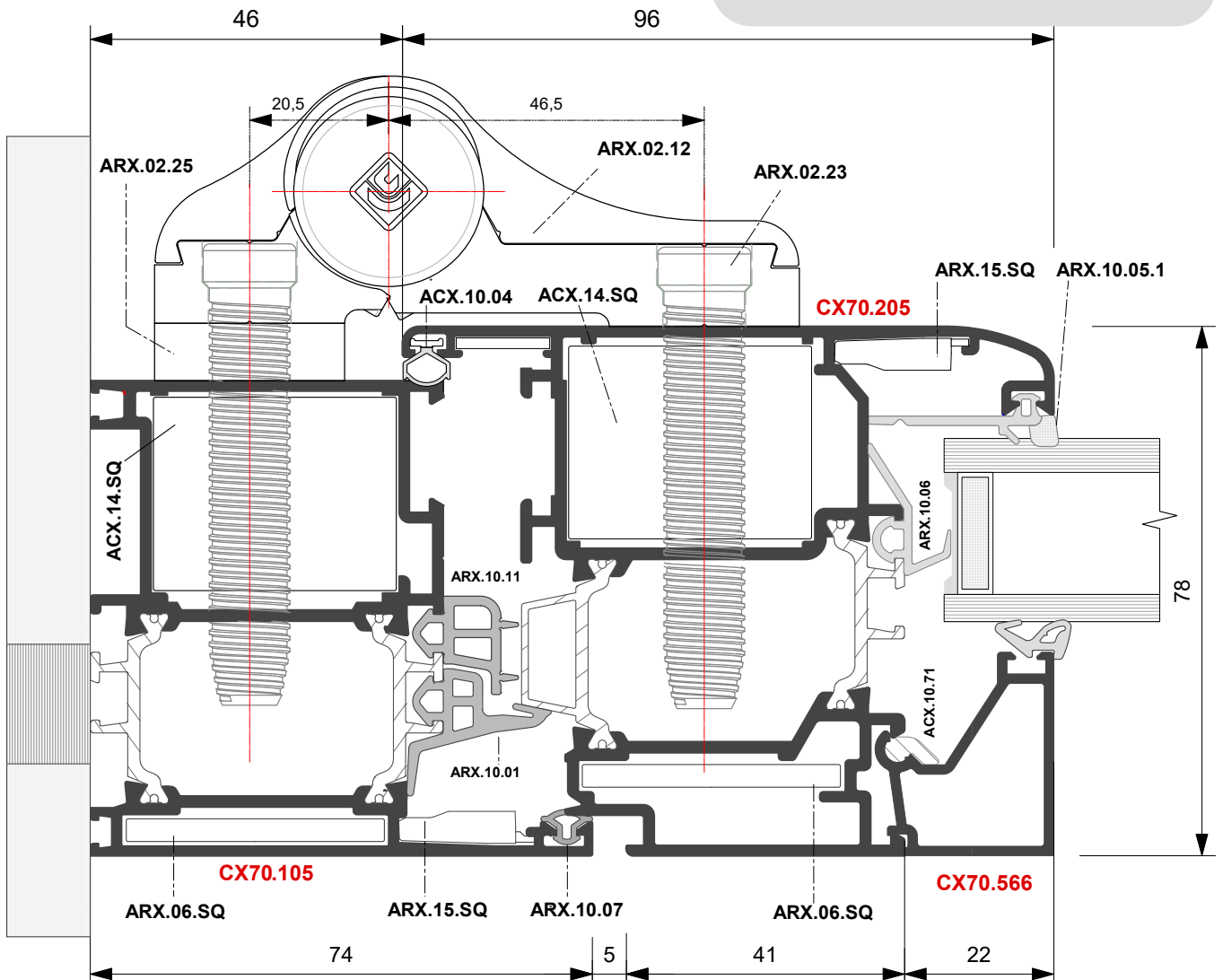
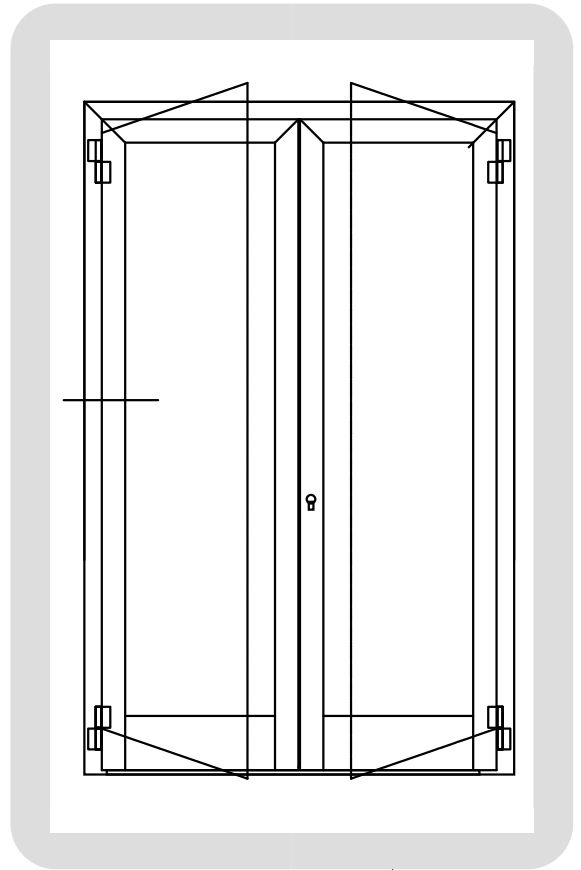



**PORTA INGRESSO AD UNA ANTA**  
Apertura esterna

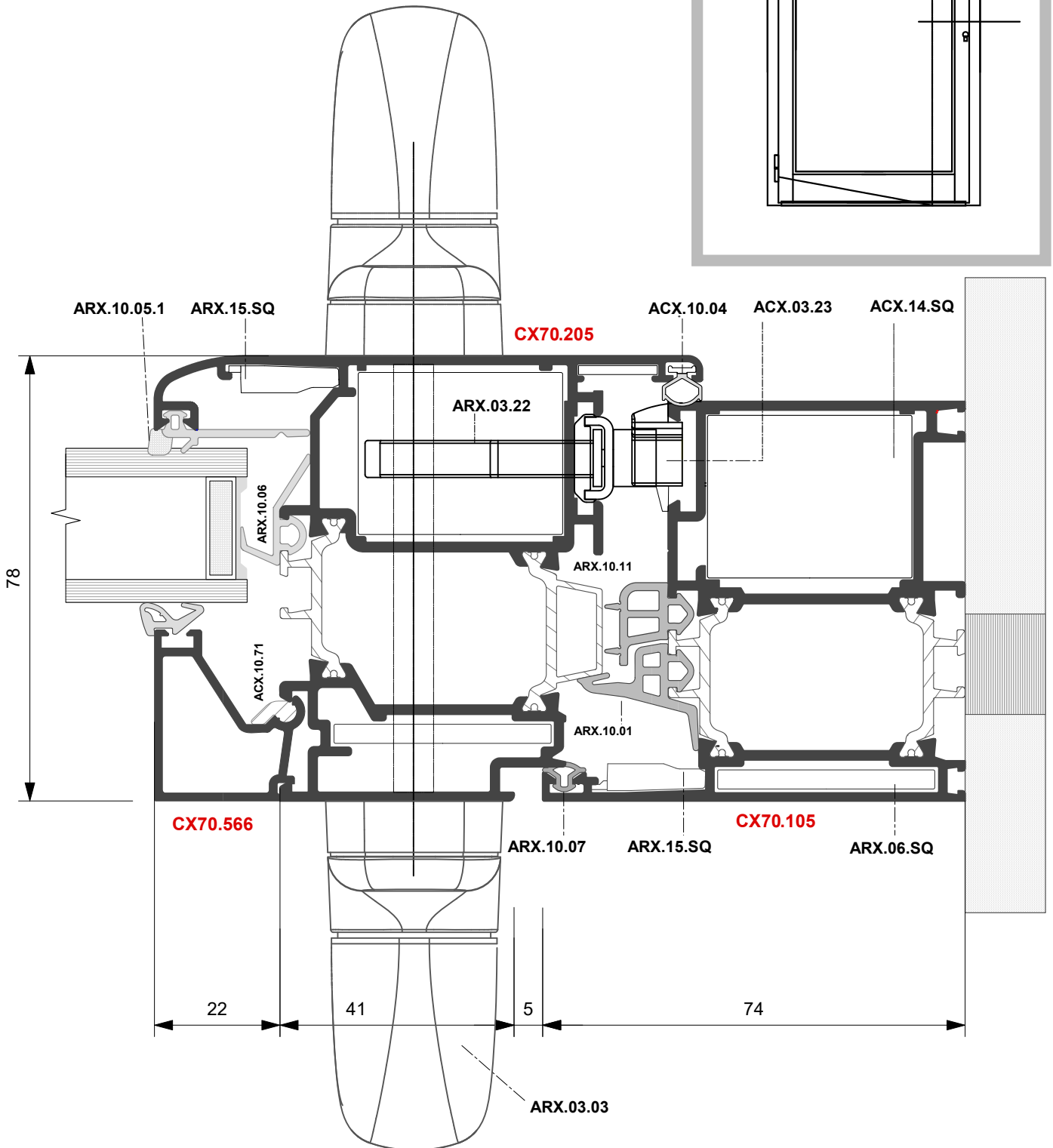
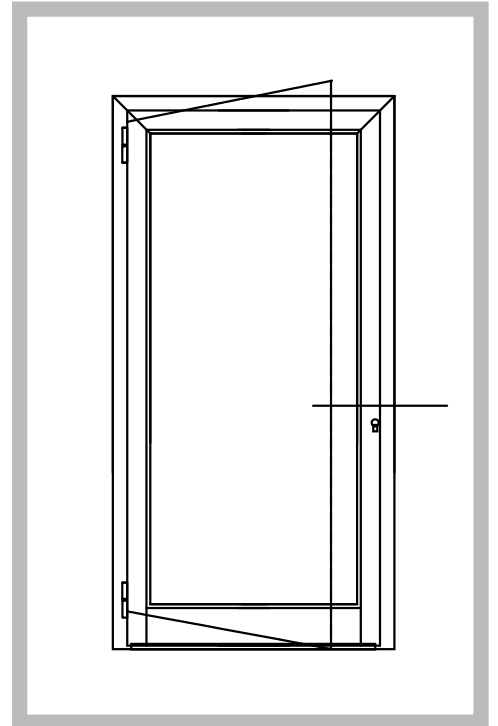

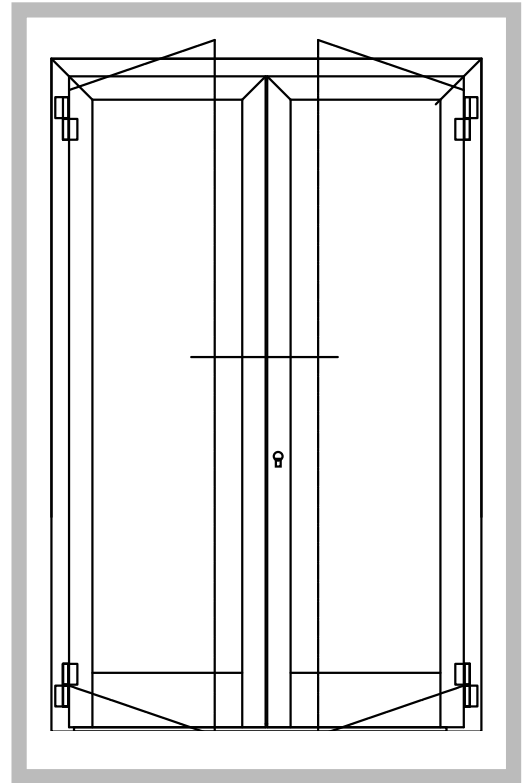
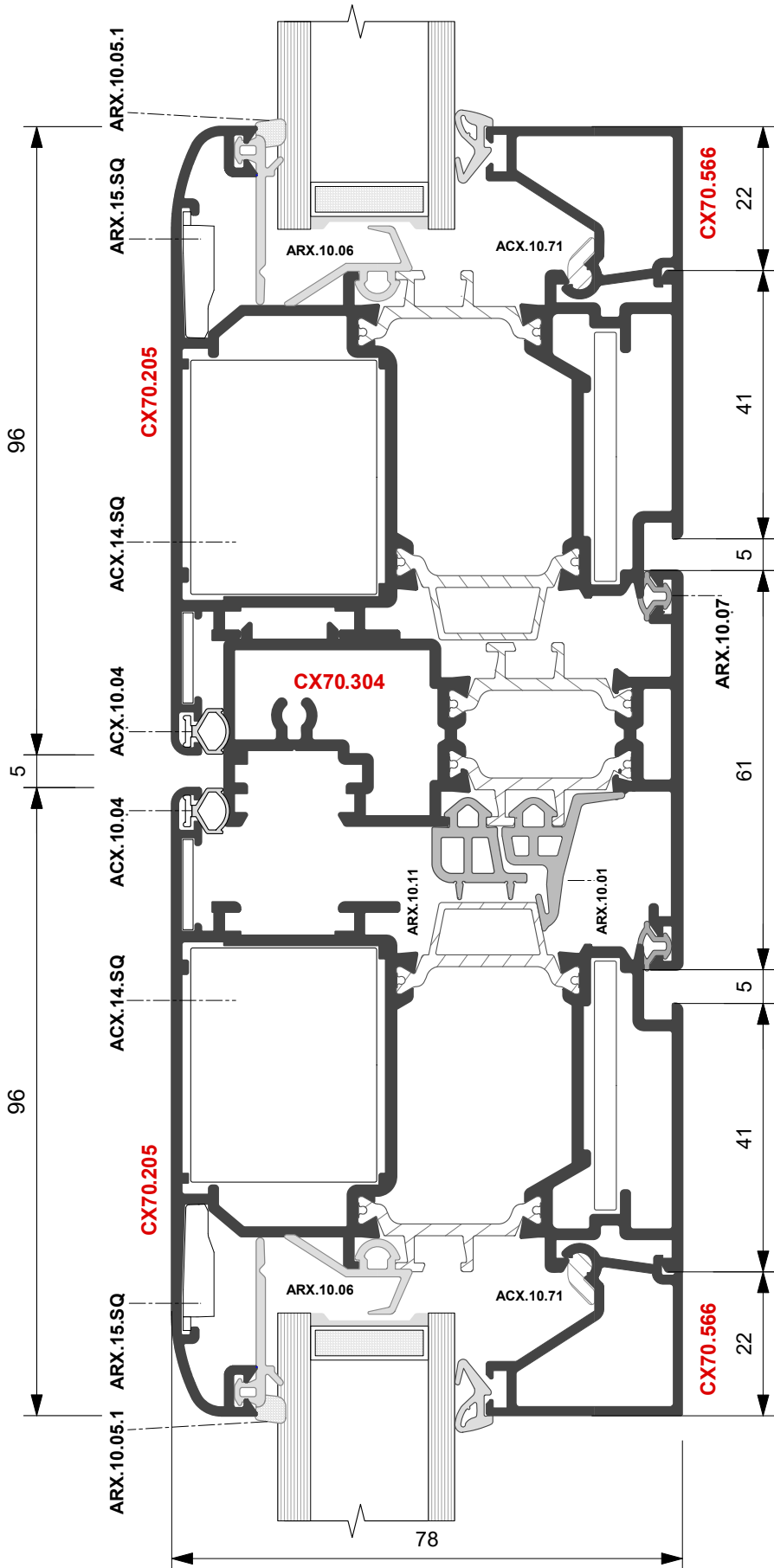

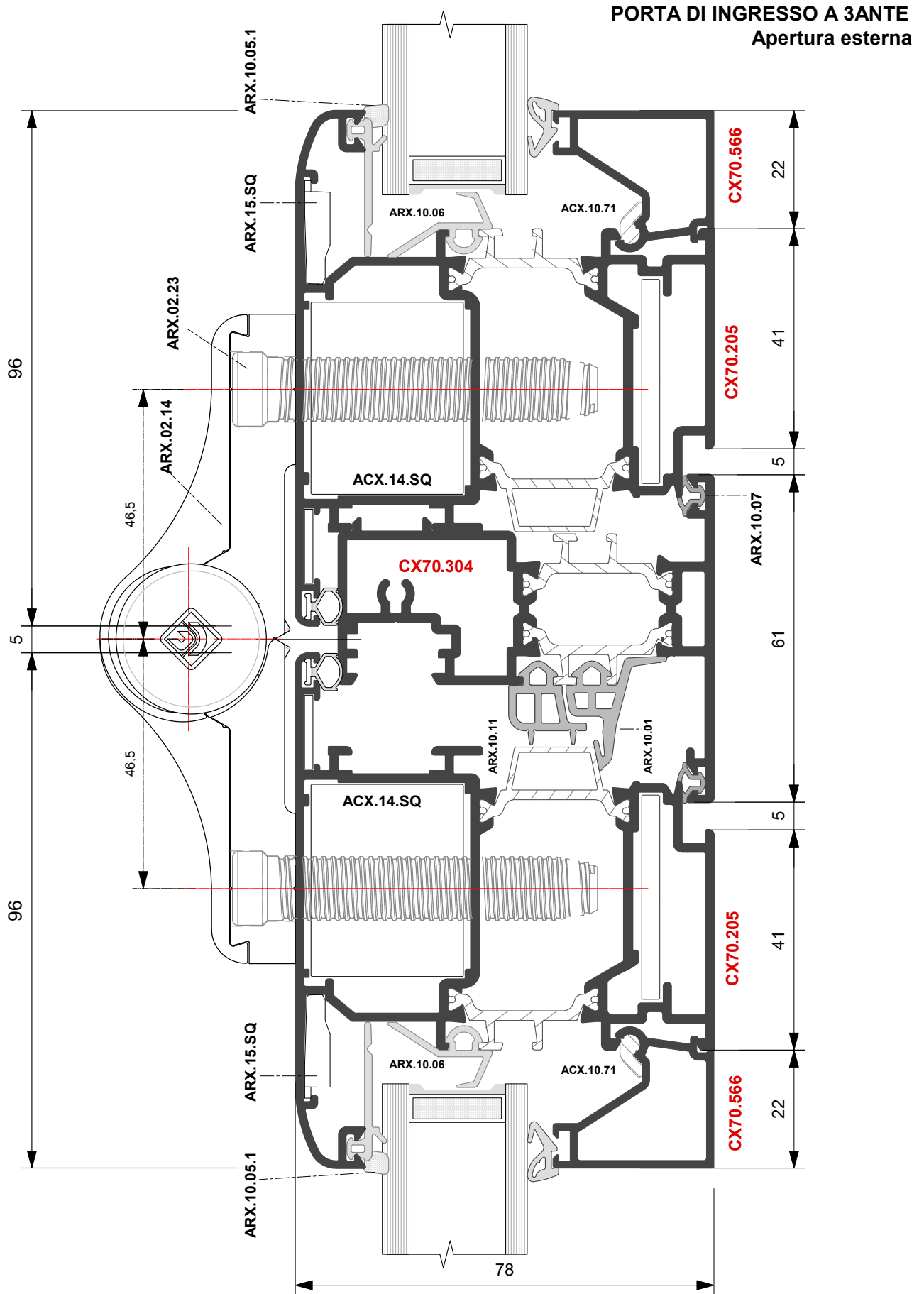



**PORTA A DUE ANTE CON SOPRALUCE FISSO**  
Apertura esterna

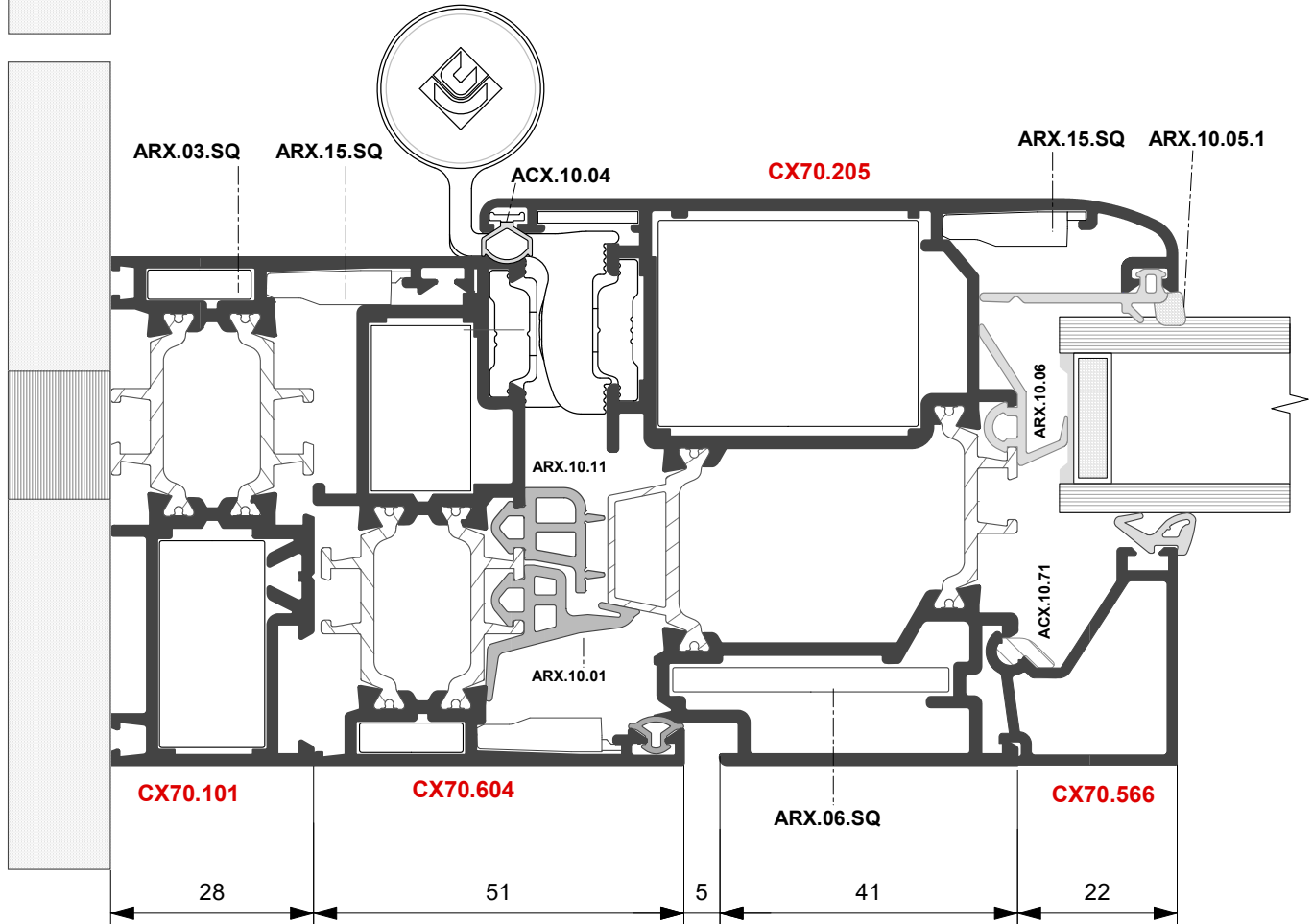
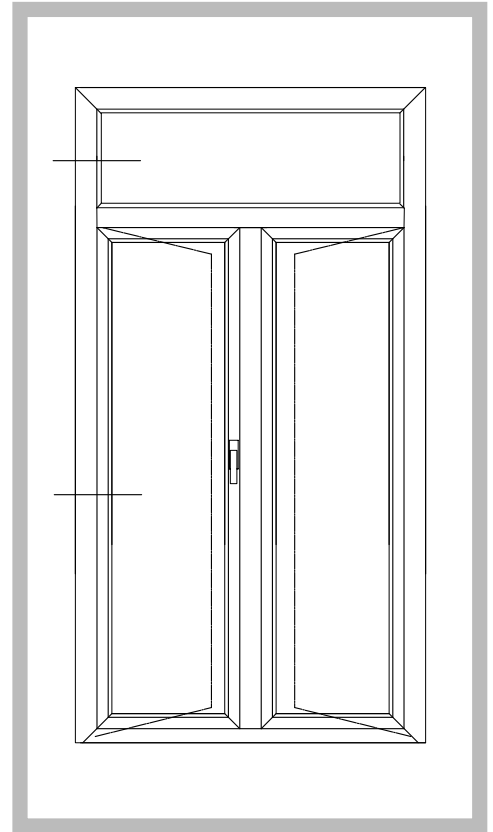
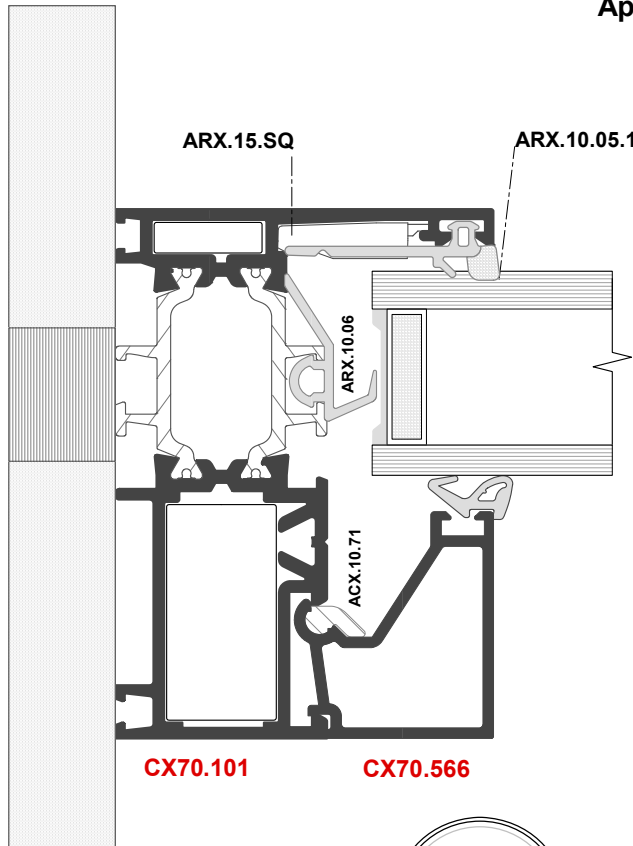





**PORTA INGRESSO A DUE ANTE**  
Apertura interna

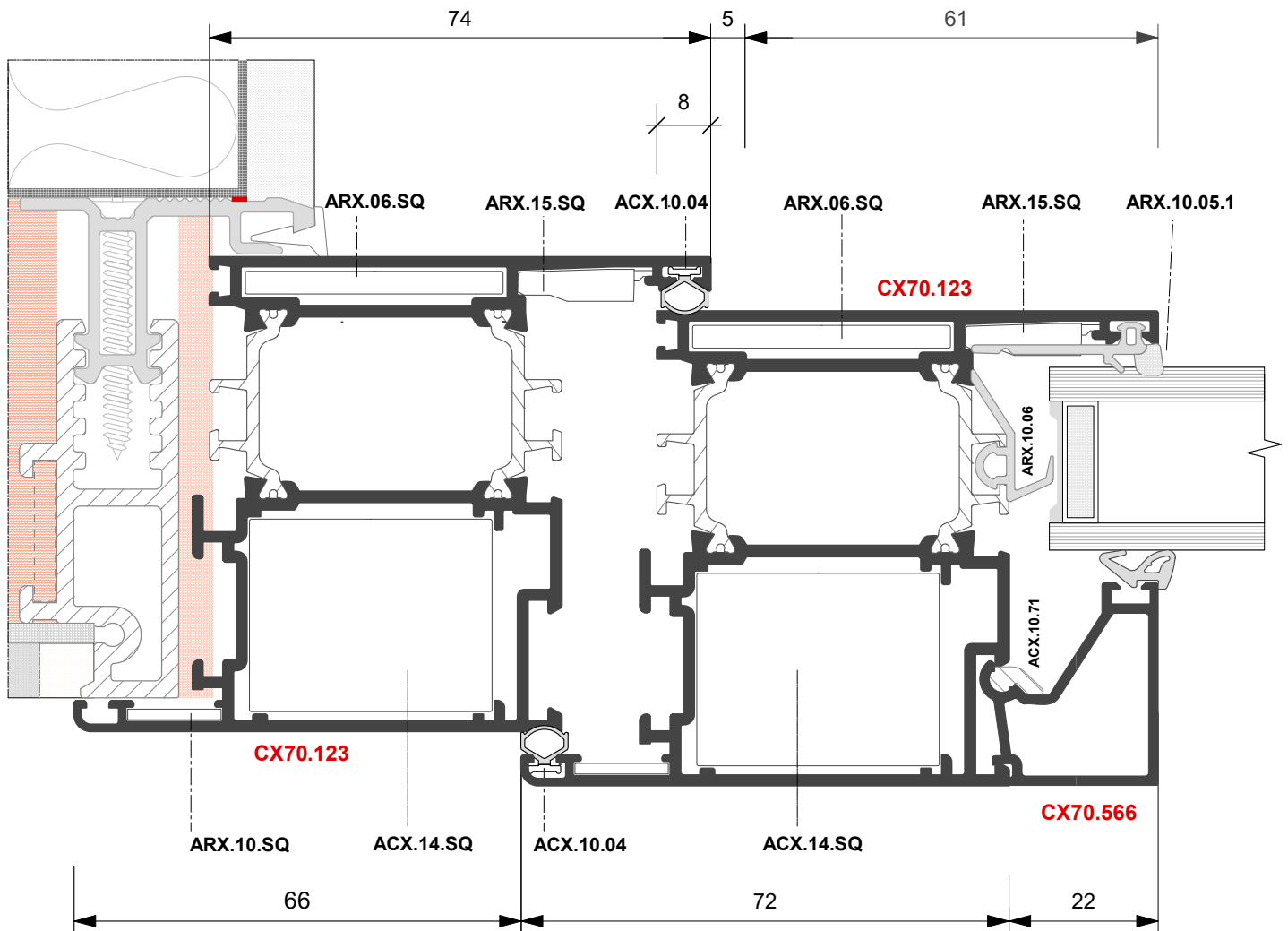
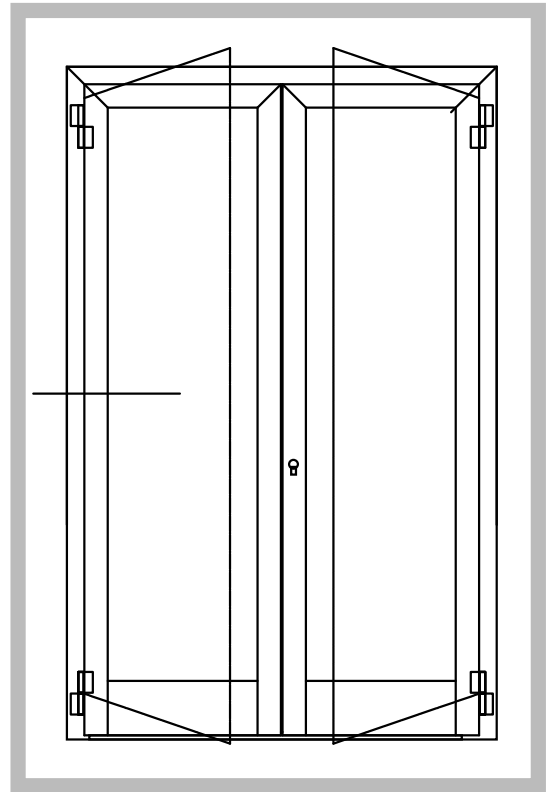



**PORTA INGRESSO A DUE ANTE**  
Apertura interna

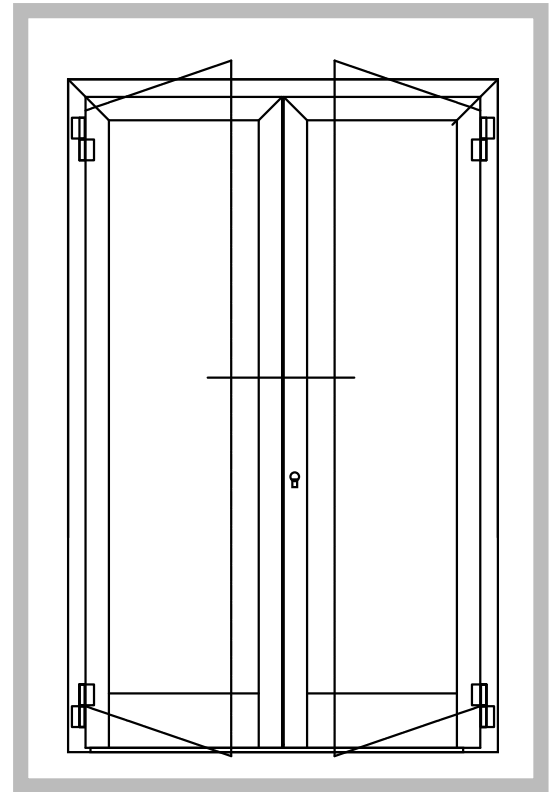
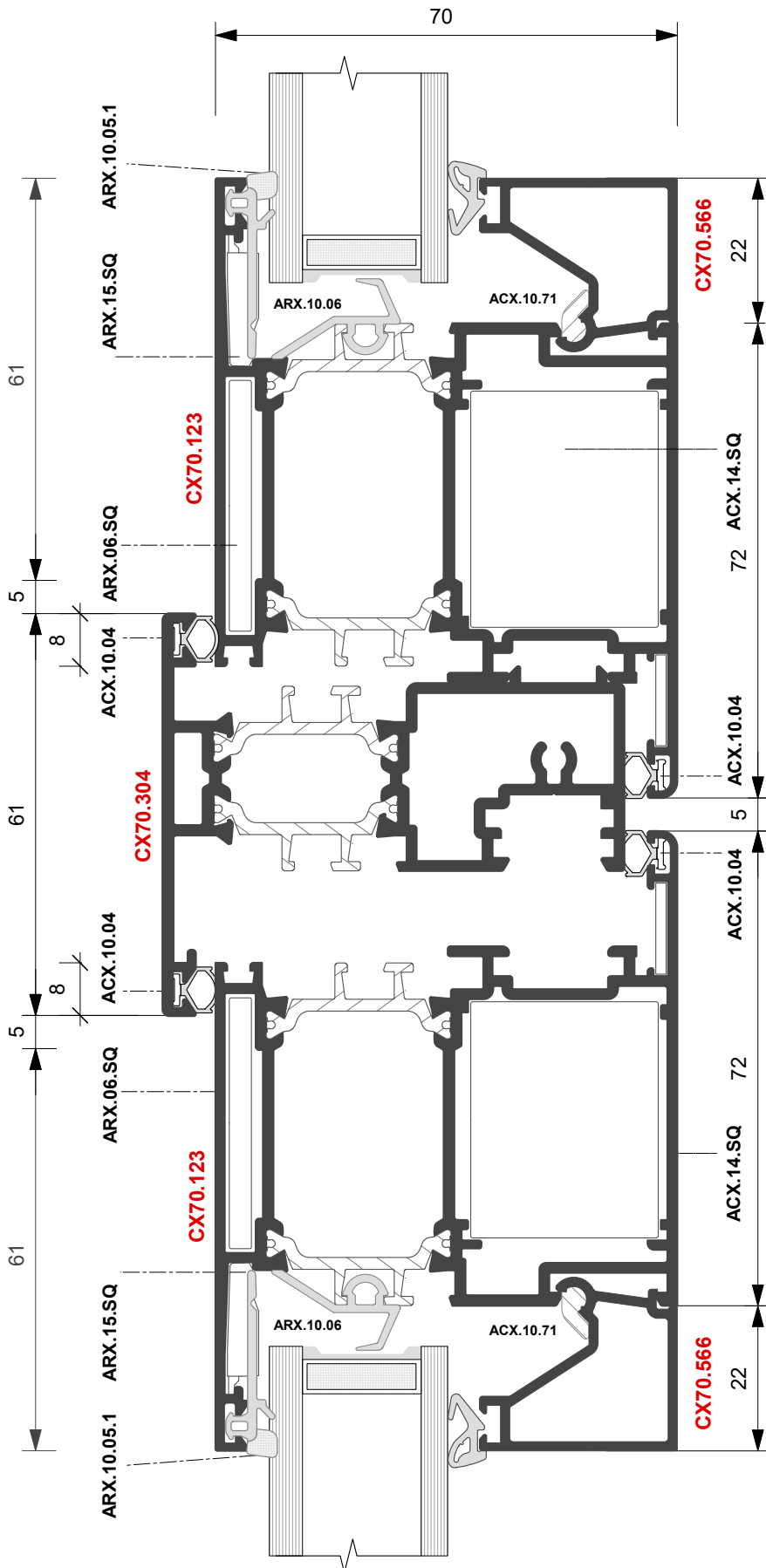



**FINESTRA MONOBLOCCO**

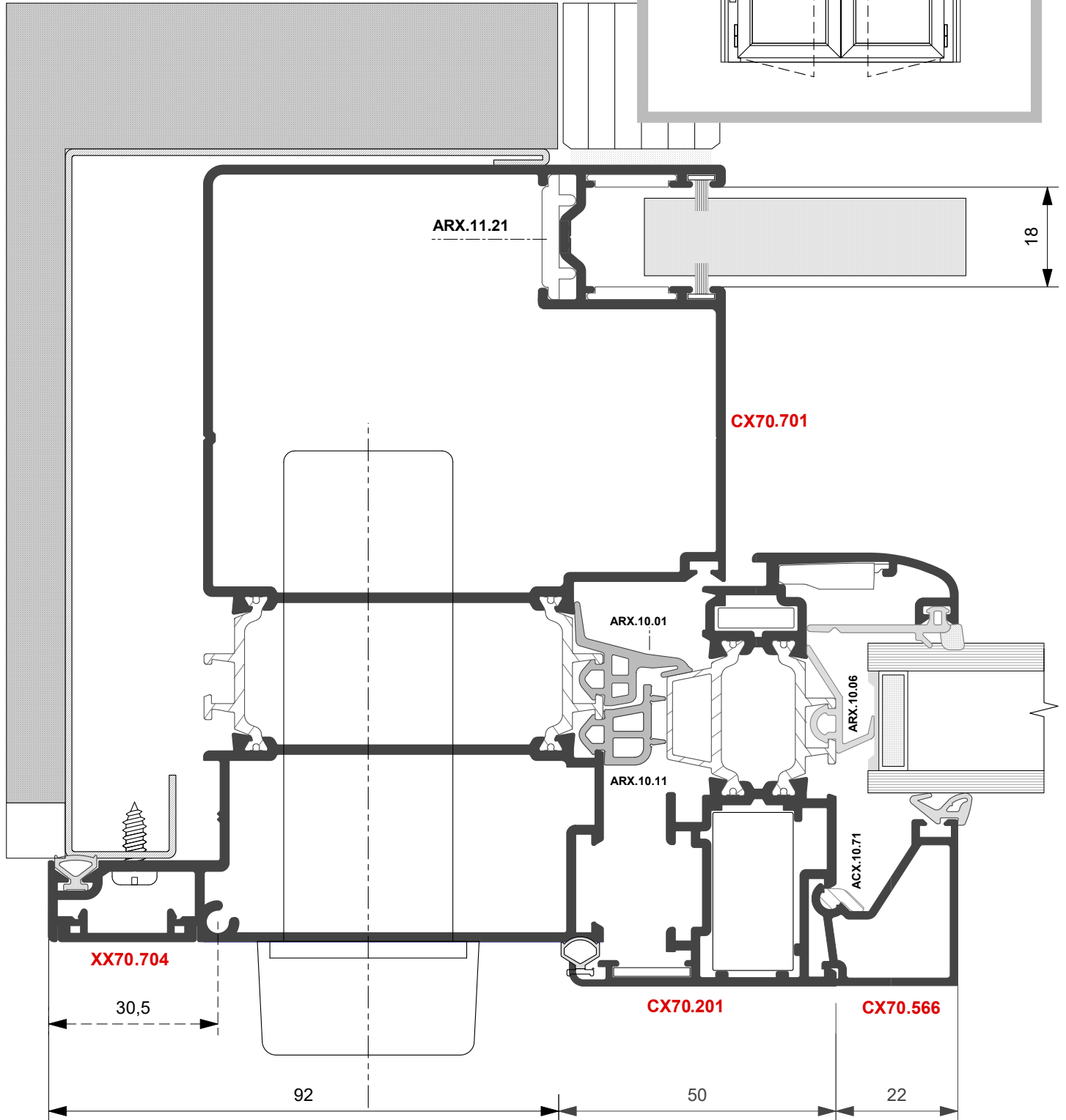
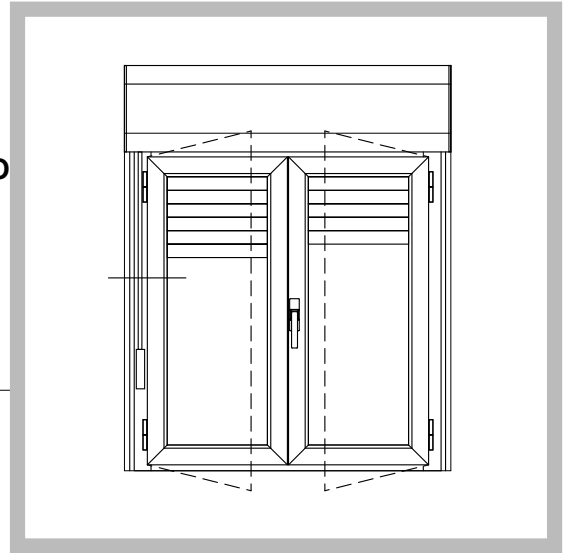



**FINESTRA MONOBLOCCO**

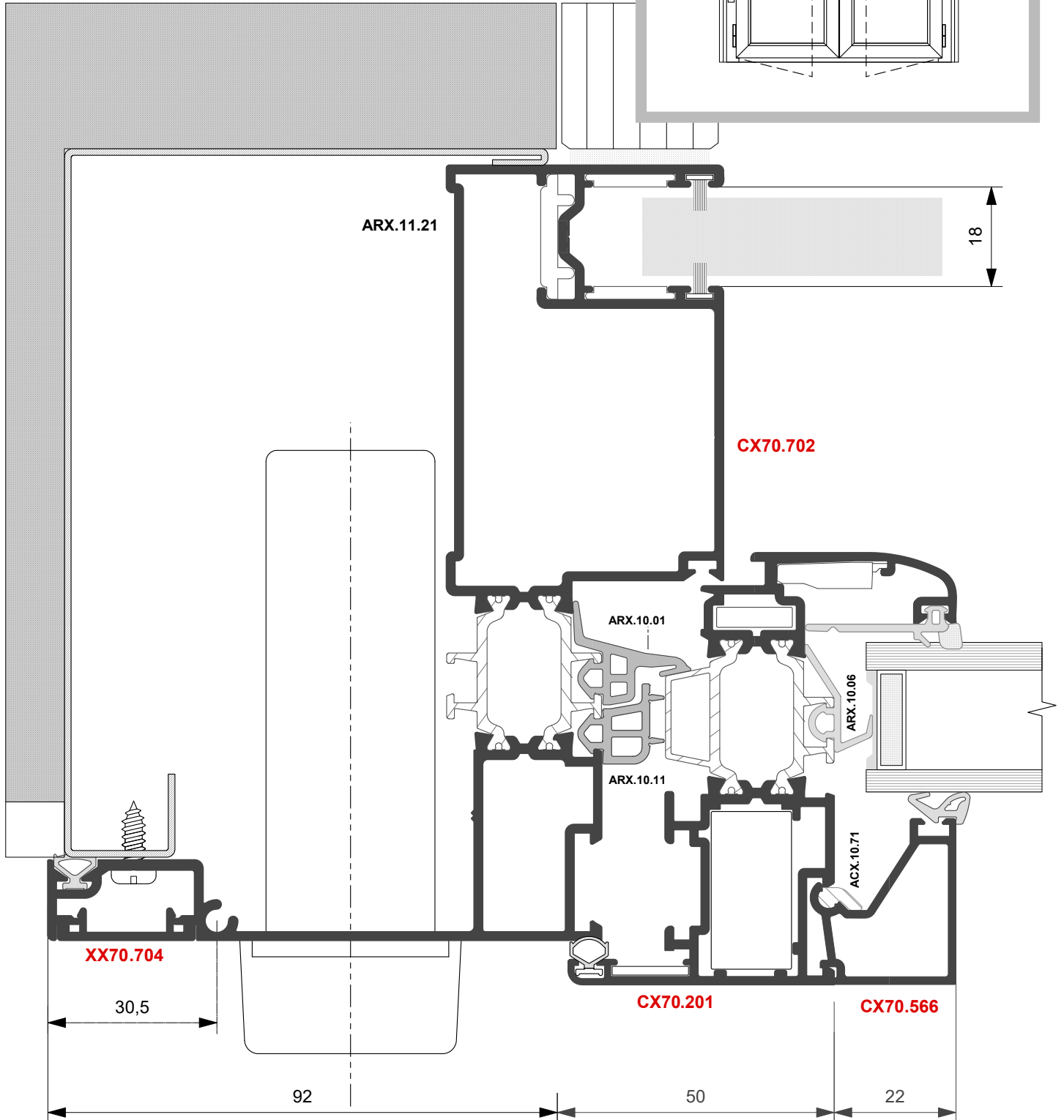
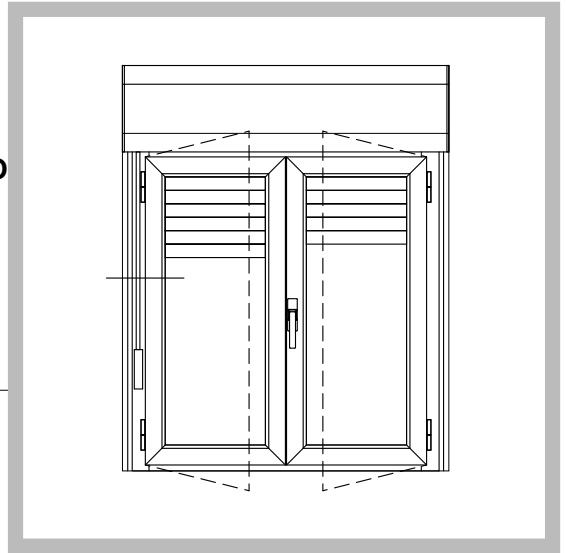



**FINESTRA MONOBLOCCO**

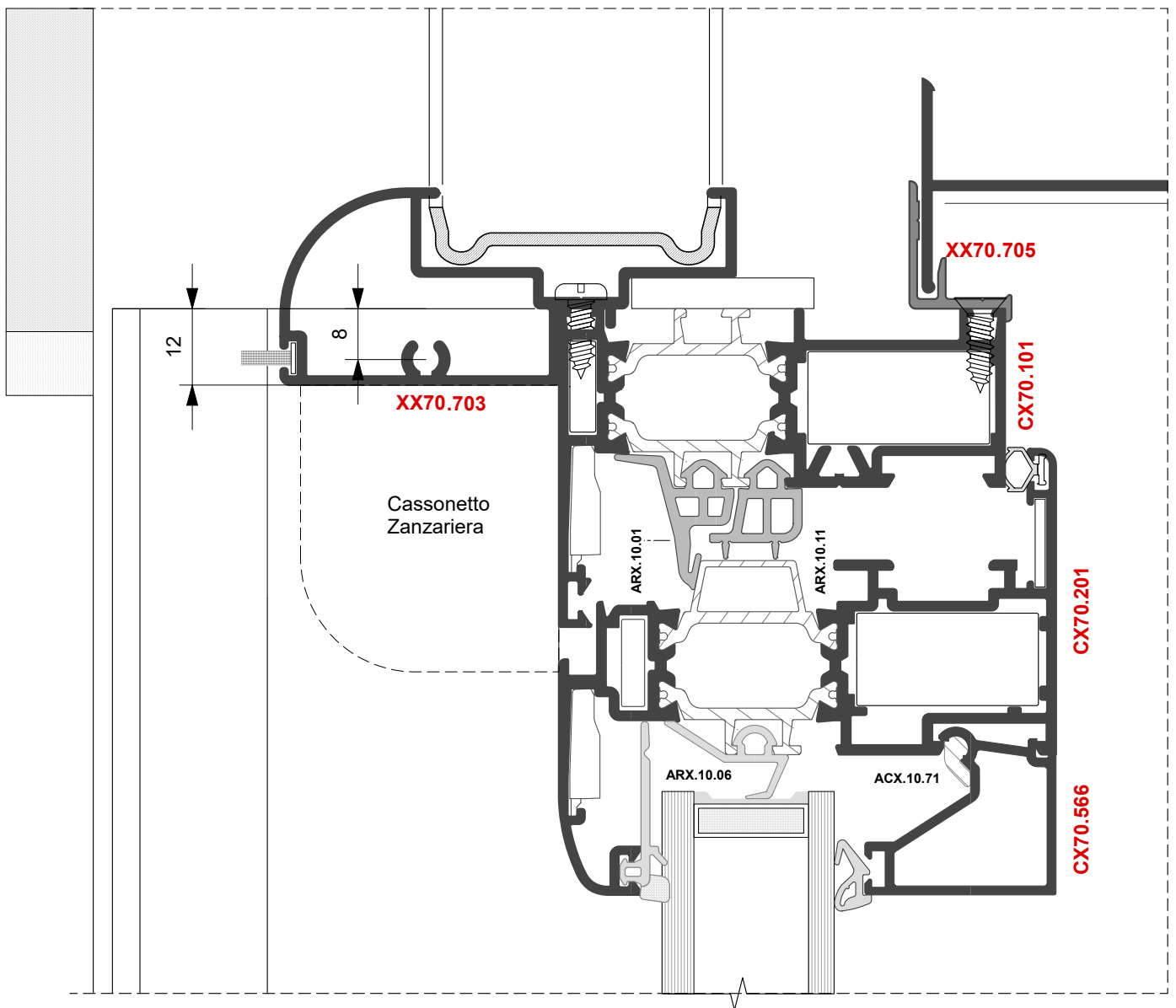
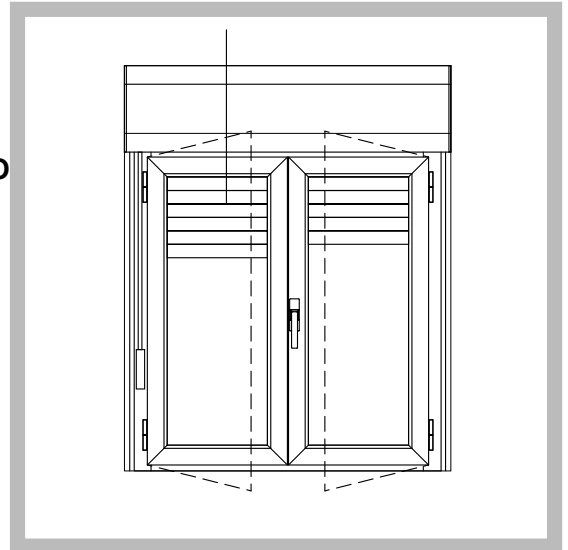



**FINESTRA MONOBLOCCO**

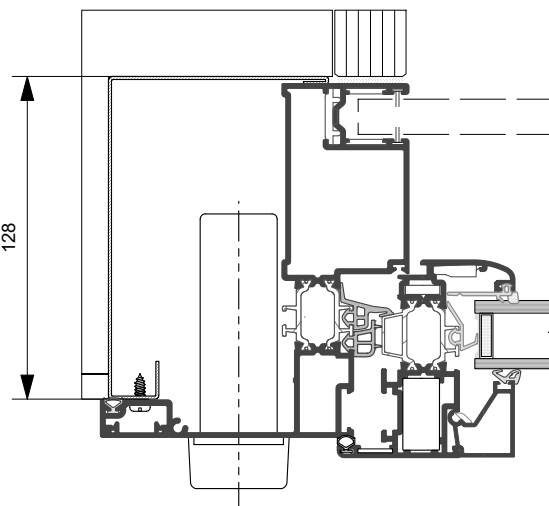
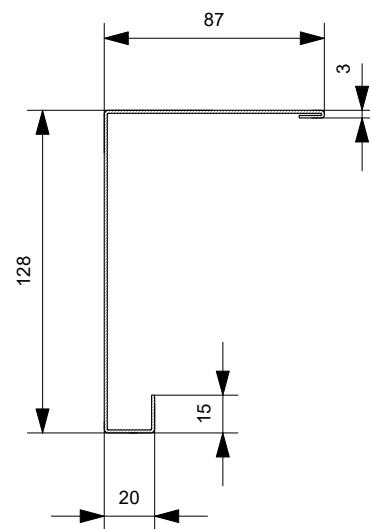
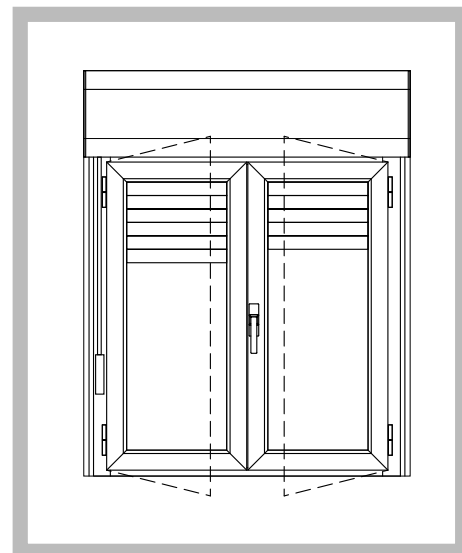
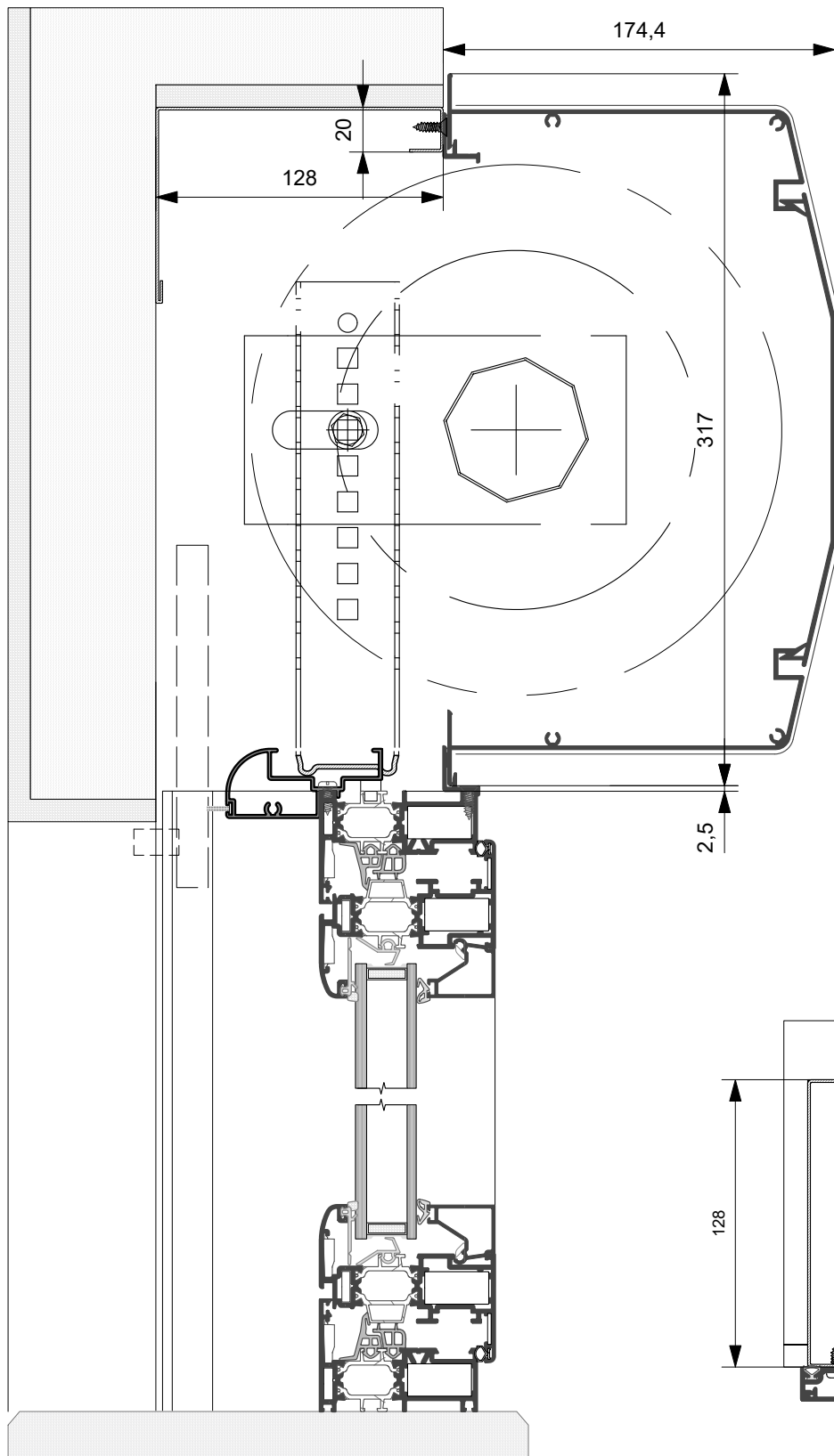



**FINESTRA A DUE ANTE**

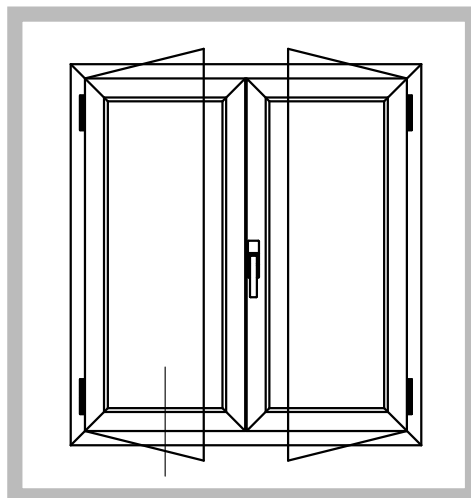
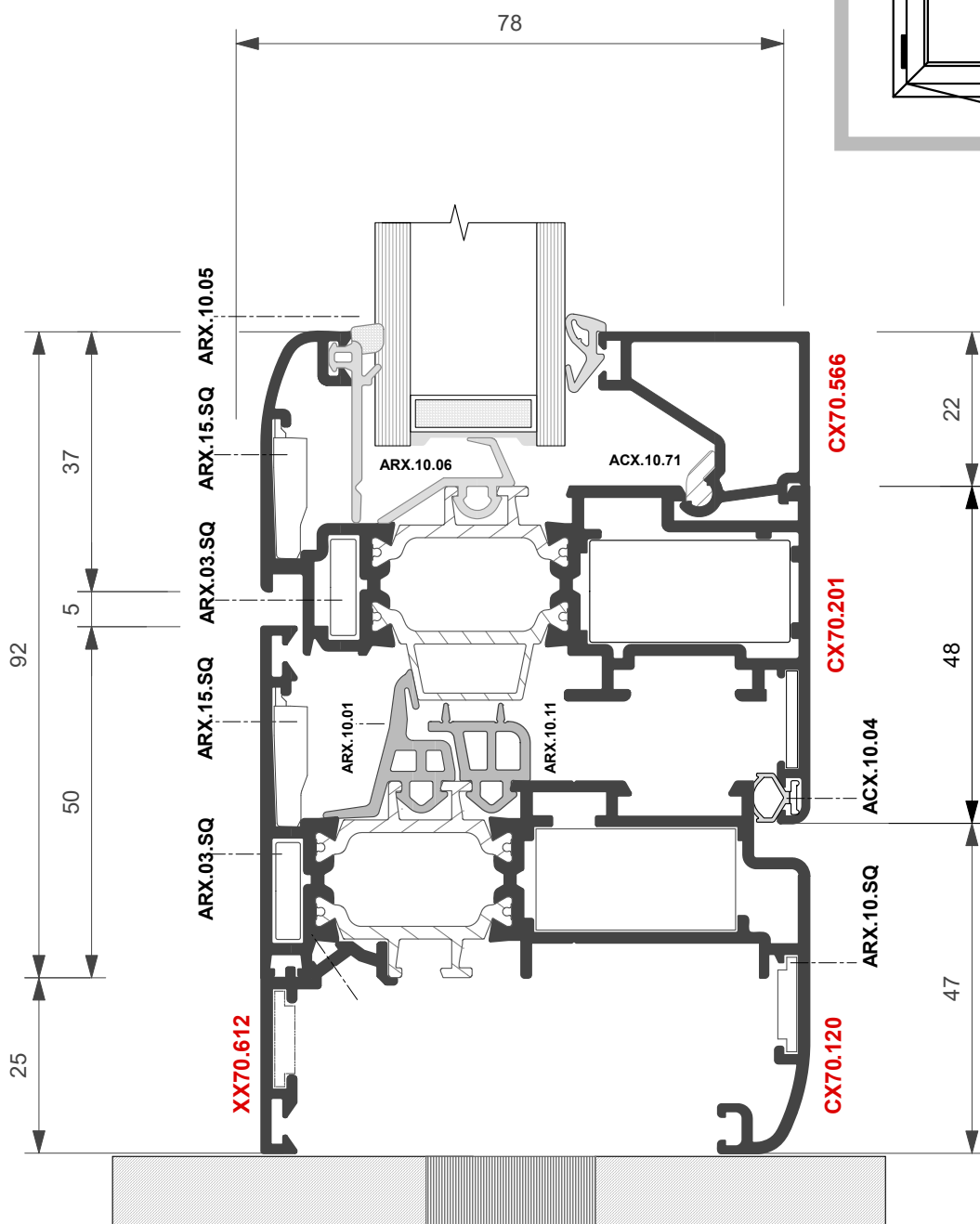

**FINESTRA A DUE ANTE**  
con scuretto

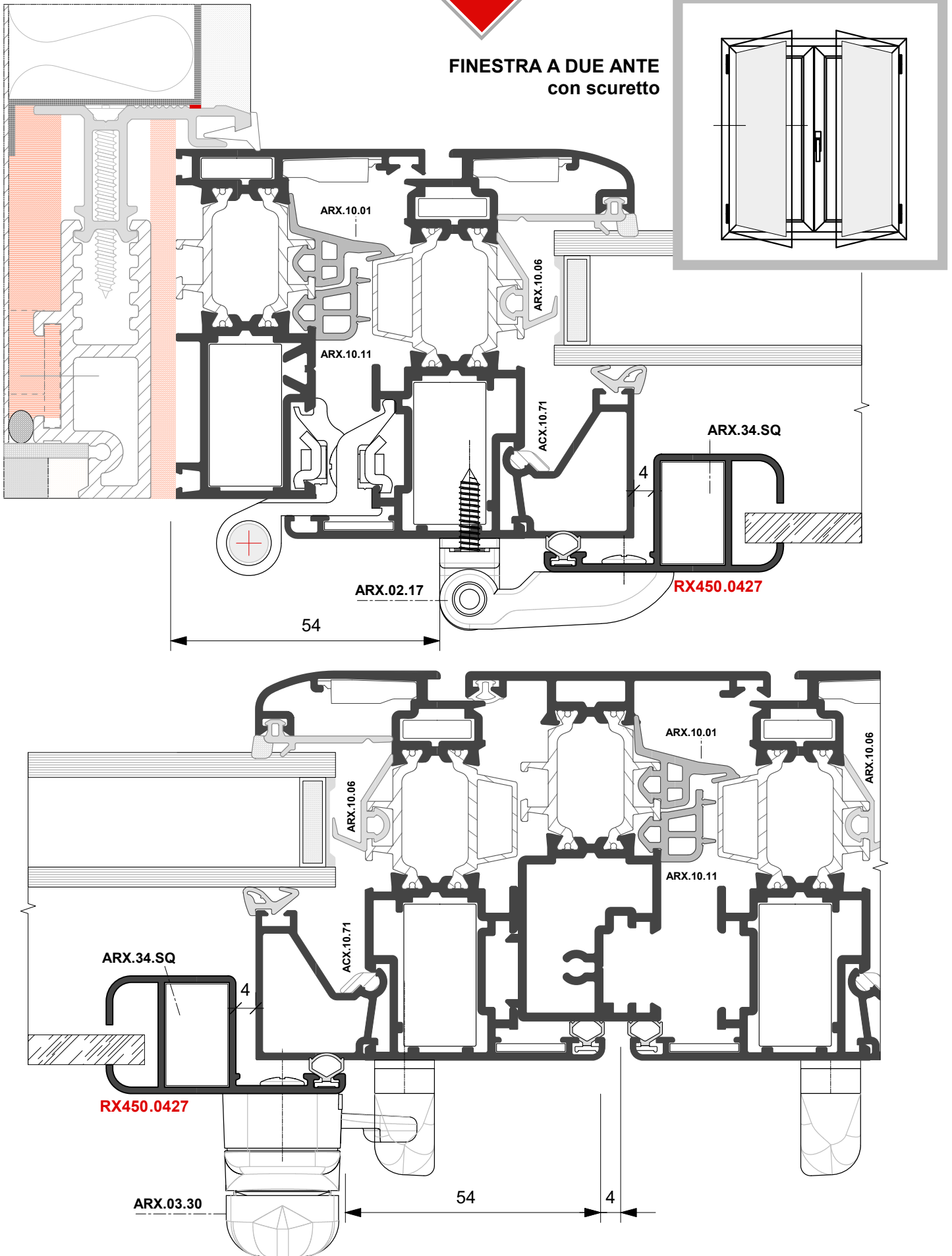





Serie **SLIM**  
FINESTRA A DUE ANTE

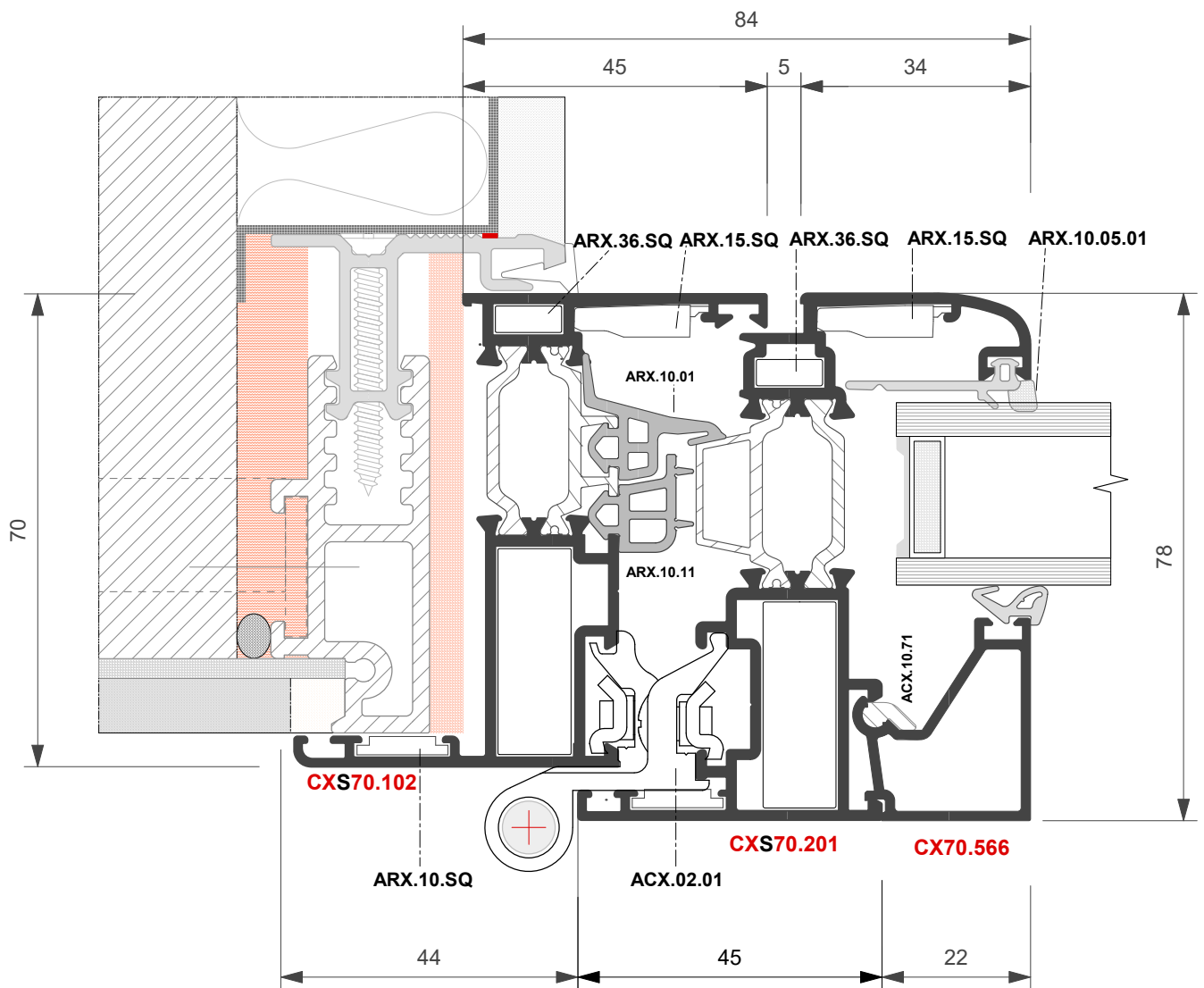
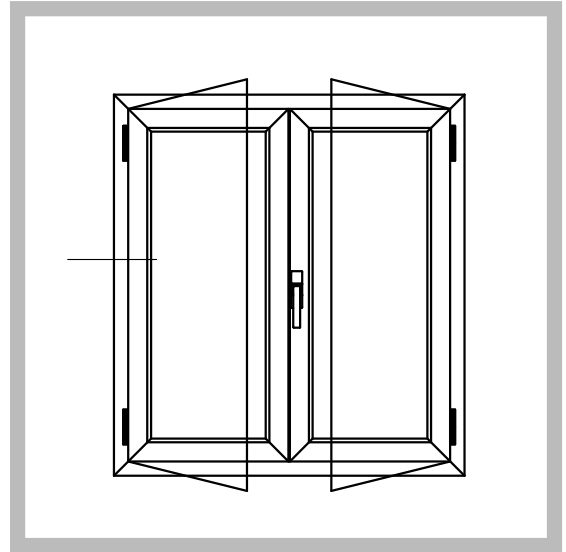



Serie **SLIM**  
FINESTRA A DUE ANTE

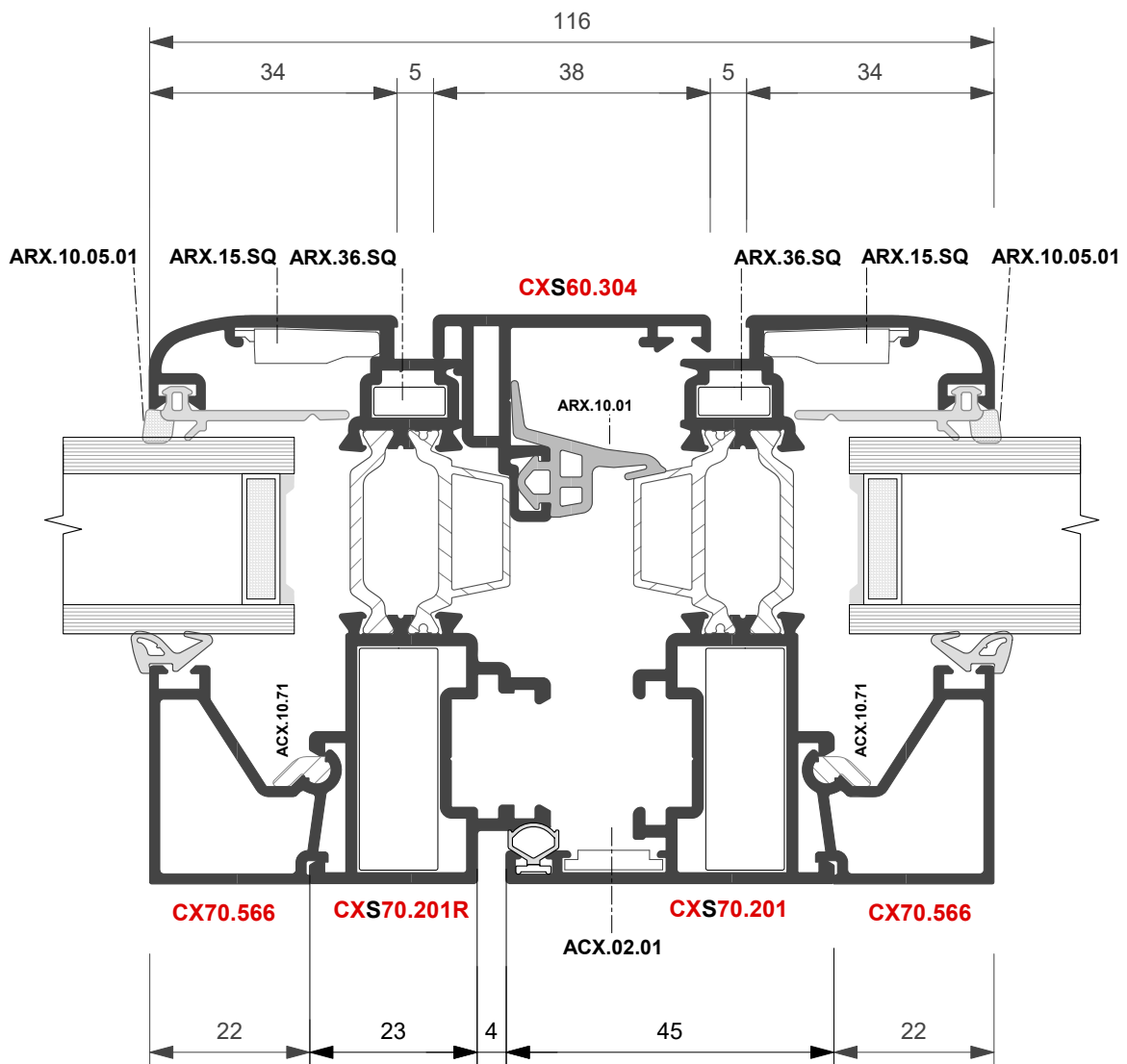
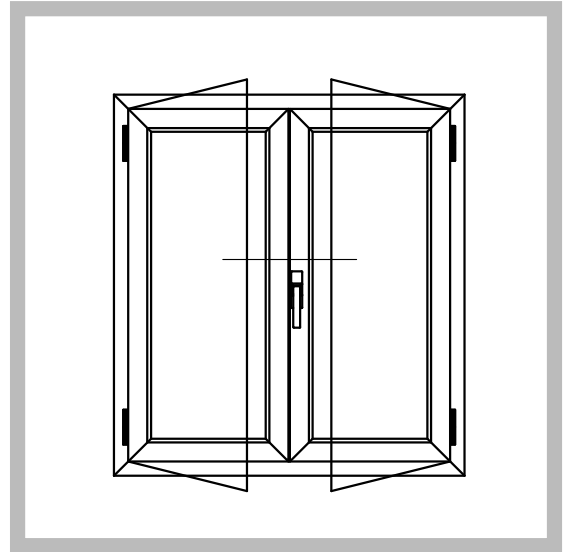



**FINESTRA A DUE ANTE**  
Apertura esterna

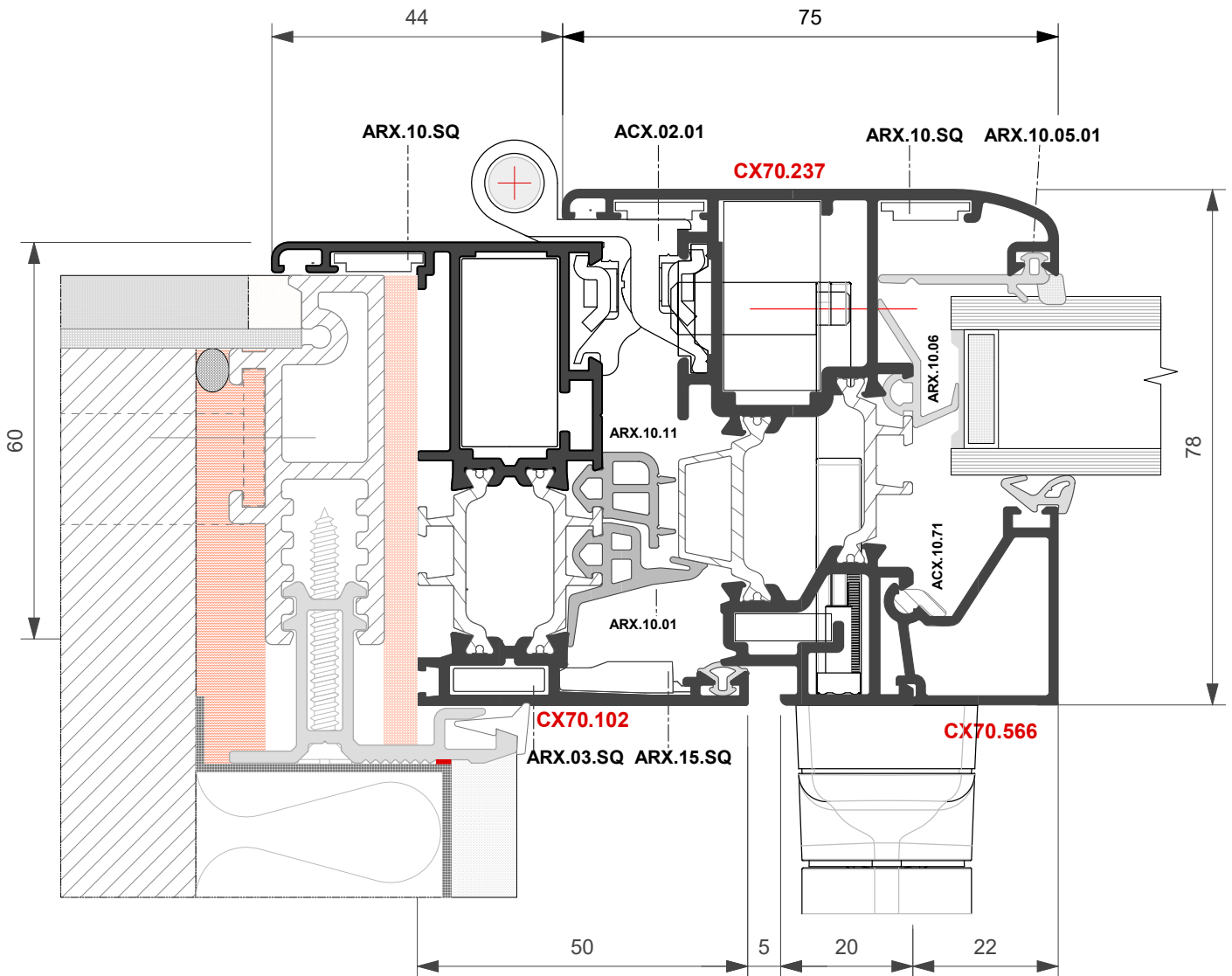
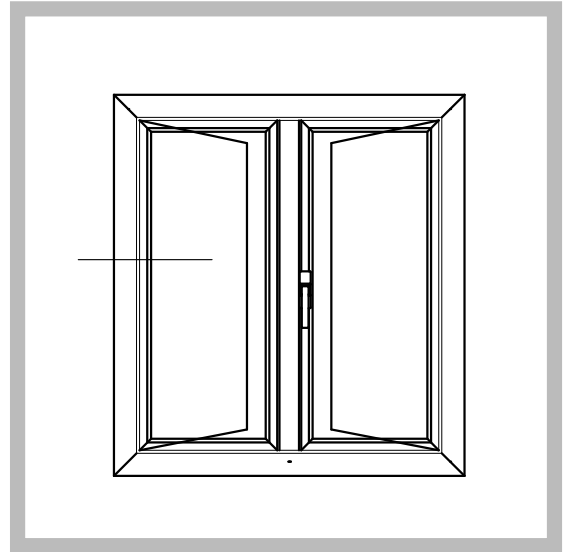



**FINESTRA A DUE ANTE**  
Cerniera a scomparsa  
Salto 10 mm.

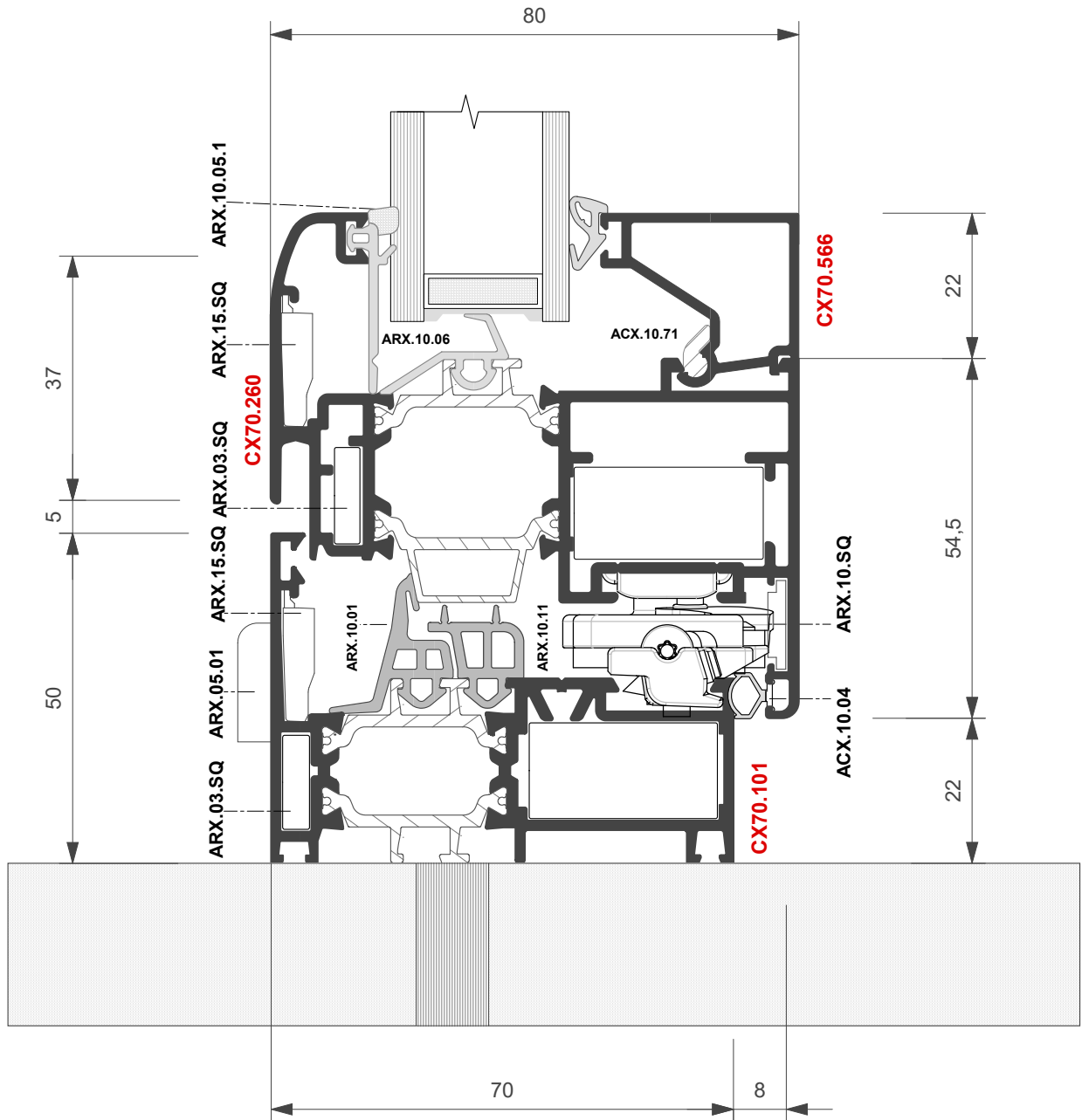
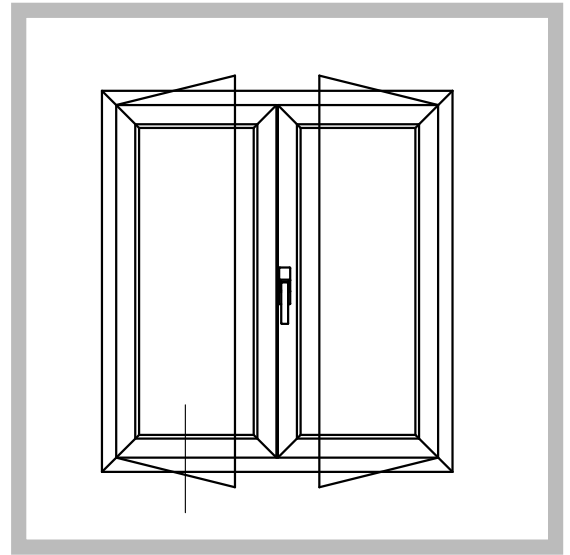



Tipologie

Gruppo **E** Principali tipologie di finestre



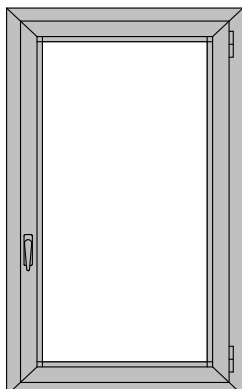

### Finestra a 1 anta

Distinta di taglio vetri		
Q.ta	H	L
1	H - 150	L - 150

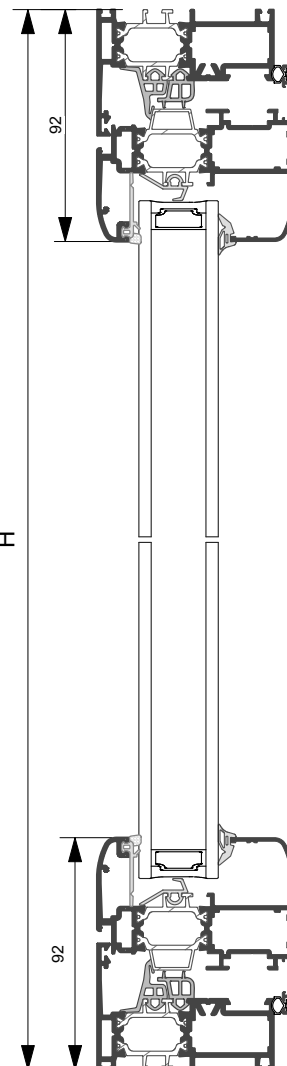
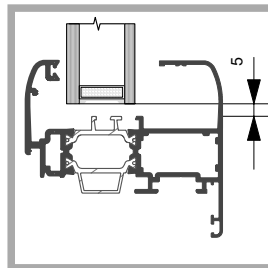

### Accessori e guarnizioni

Codice	Descrizione	Q.ta	Codice	Descrizione	Q.ta
<b>ACX.01.SQ</b>	Squadretta a pulsante	8	<b>ARX.05.01</b>	Copriasola scarico acqua	2
<b>ARX.03.SQ</b>	Squadretta cianfrinare est.	8	<b>ARX.06.01</b>	Espansore	*
<b>ARX.15.SQ</b>	Squadretta allin. telaio/anta	8	<b>ARX.10.01</b>	Guarnizione precamera	2L,2H
<b>ARX.10.SQ</b>	Squadretta allin. anta int.	4	<b>ACX.10.04</b>	Guarnizione battuta	2L,2H
<b>ACX.02.01</b>	Cerniera a 2 ali	2	<b>ARX.10.05</b>	Guarnizione vetro esterna	2L,2H
<b>ARX.03.06</b>	Cremonese pressofusa	1	*	Guarnizione vetro interna	2L,2H
<b>ACX.03.17</b>	Innesti cremonese	2	<b>ARX.10.02</b>	Angolo guar. precamera	4
<b>ACX.03.18</b>	Teminale astina	2	<b>ARX.10.11</b>	Guarn. suppl. precamera	2L,2H
<b>ACX.03.13</b>	Ferrogliera	2			

\* secondo dimensioni

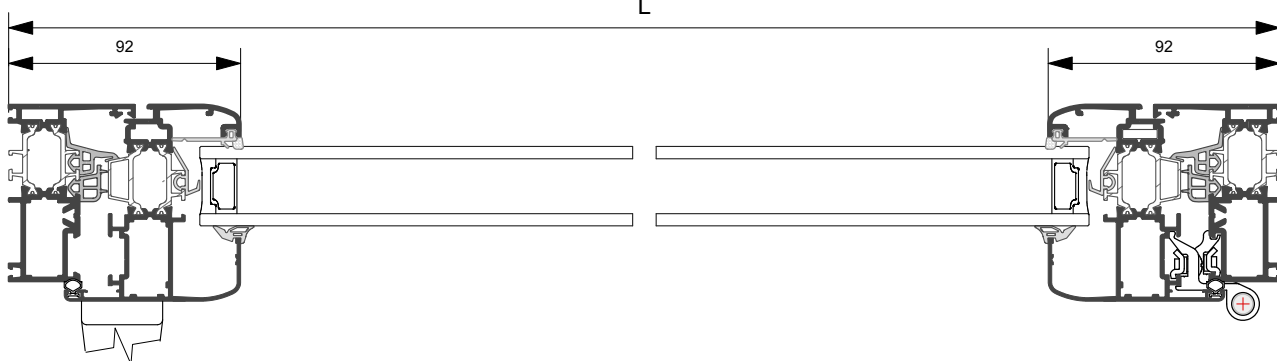

Profilo	Taglio	Q.ta	Profilo	Taglio	Q.ta	Profilo	Taglio	Q.ta
CX70.101	L	2	CX70.605					
	H	2						
CX70.203	L - 44	2						
	H - 44	2						

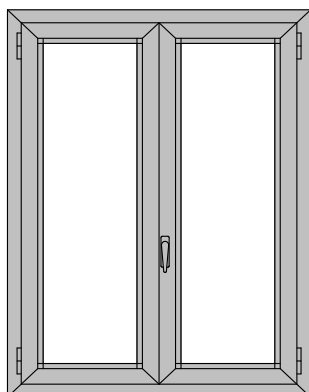

### Finestra a 2 ante

Distinta di taglio vetri

Q.ta	H	L
2	H -150	L/2 -132

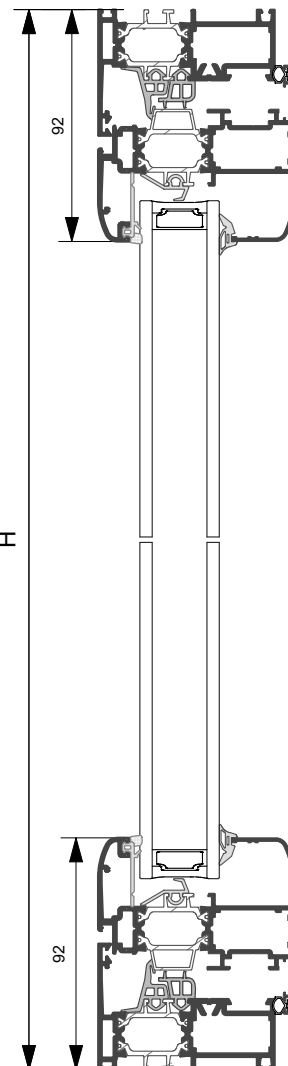
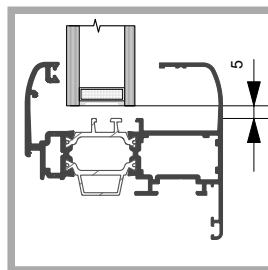

### Accessori e guarnizioni

Codice	Descrizione	Q.ta	Codice	Descrizione	Q.ta
<b>ACX.01.SQ</b>	Squadretta a pulsante	12	<b>ACX.04.01</b>	Tappo riporto centrale	1
<b>ARX.03.SQ</b>	Squadretta cianfrinare est.	12	<b>ARX.05.01</b>	Copriasola scarico acqua	2
<b>ARX.15.SQ</b>	Squadretta allin. telaio/anta	12	<b>ARX.06.01</b>	Espansore	*
<b>ARX.10.SQ</b>	Squadretta allin. anta int.	8	<b>ARX.10.01</b>	Guarnizione precamera	2L,3H
<b>ACX.02.01</b>	Cerniera a 2 ali	4	<b>ACX.10.04</b>	Guarnizione battuta	2L,4H
<b>ARX.03.06</b>	Cremonese pressofusa	1	<b>ARX.10.05</b>	Guarnizione vetro esterna	2L,4H
<b>ACX.03.17</b>	Innesti cremonese	2	*	Guarnizione vetro interna	2L,4H
<b>ACX.03.18</b>	Teminale astina	2	<b>ARX.10.02</b>	Angolo guarn. precamera	4
<b>ACX.03.11</b>	Paletto a spinta	2	<b>ARX.10.11</b>	Guarn. suppl. precamera	2L,3H
<b>ACX.03.14</b>	Ferrogliera	2	* secondo dimensioni		

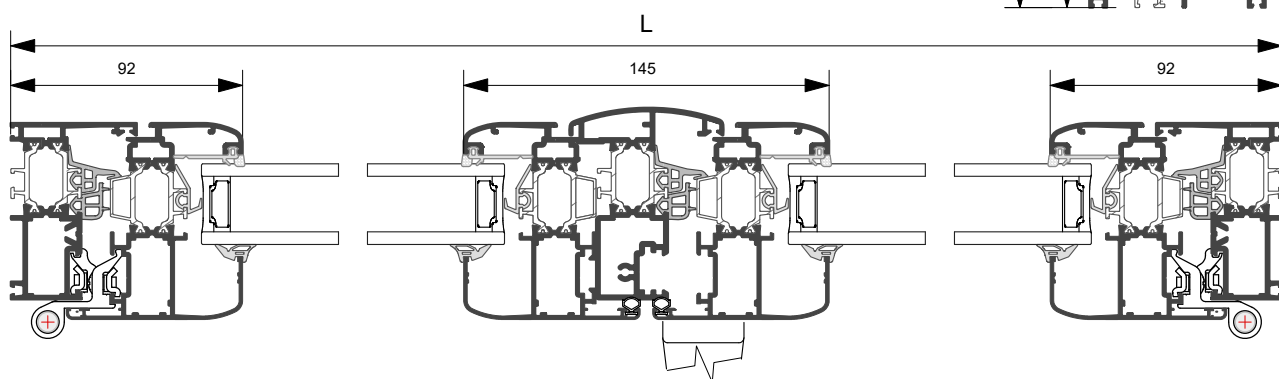

Profilo	Taglio	Q.ta	Profilo	Taglio	Q.ta	Profilo	Taglio	Q.ta
CX70.101	L	2	CX70.301	H - 110	1			
	H	2						
CX70.203	L/2 - 24.5	4	CX70.605					
	H - 44	4						

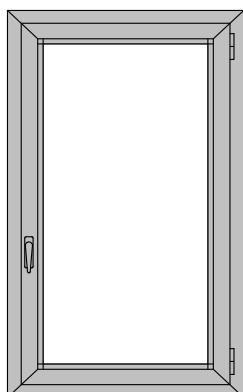

## Finestra a 1 anta

Distinta di taglio vetri		
Q.ta	H	L
1	H -150	L -150

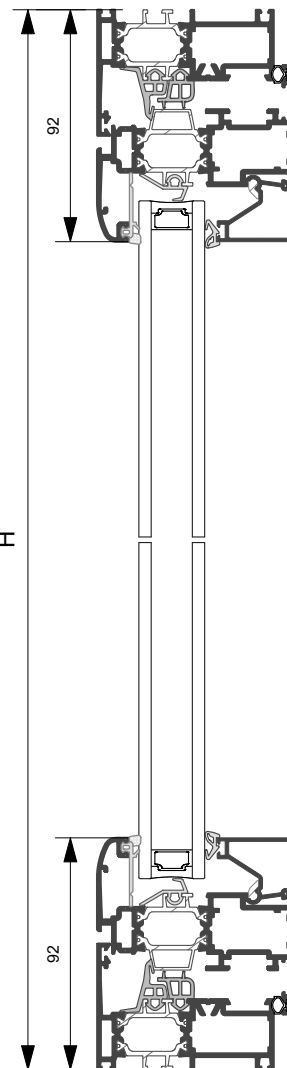
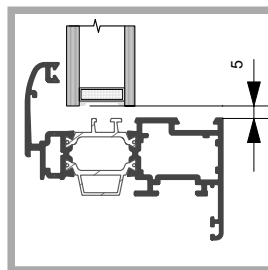

## Accessori e guarnizioni

Codice	Descrizione	Q.ta	Codice	Descrizione	Q.ta
<b>ACX.01.SQ</b>	Squadretta a pulsante	8	<b>ARX.05.01</b>	Copriasola scarico acqua	2
<b>ARX.03.SQ</b>	Squadretta cianfrinare est.	8	<b>ARX.06.01</b>	Espansore	*
<b>ARX.15.SQ</b>	Squadretta allin. telaio/anta	8	<b>ACX.07.02</b>	Angolo pressof. fermavetro	4
<b>ARX.10.SQ</b>	Squadretta allin. anta int.	4	<b>ARX.10.01</b>	Guarnizione precamera	2L,2H
<b>ACX.02.01</b>	Cerniera a 2 ali	2	<b>ACX.10.04</b>	Guarnizione battuta	2L,2H
<b>ARX.03.06</b>	Cremonese pressofusa	1	<b>ARX.10.05</b>	Guarnizione vetro esterna	2L,2H
<b>ACX.03.17</b>	Innesti cremonese	2	*	Guarnizione vetro interna	2L,2H
<b>ACX.03.18</b>	Teminale astina	2	<b>ARX.10.02</b>	Angolo guarn. precamera	4
<b>ACX.03.13</b>	Ferrogliera	2	<b>ARX.10.11</b>	Guarn. suppl. precamera	2L,2H

\* secondo dimensioni

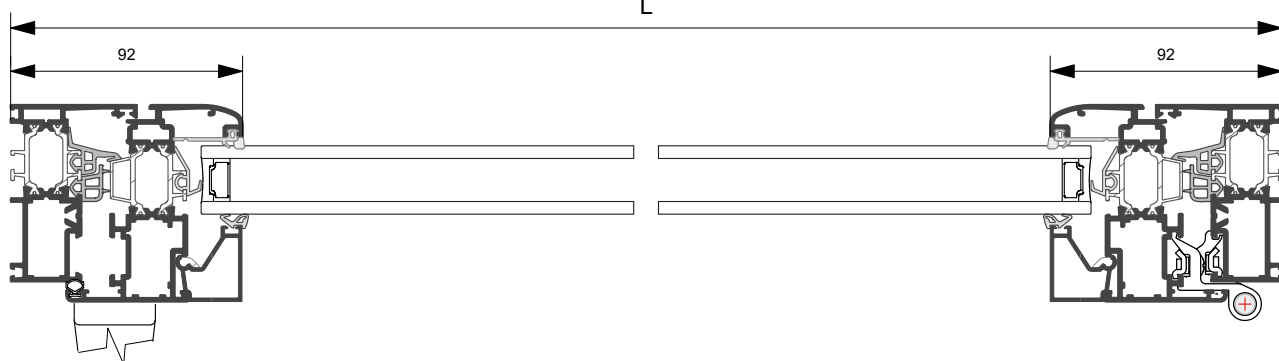

Profilo	Taglio	Q.ta	Profilo	Taglio	Q.ta	Profilo	Taglio	Q.ta
CX70.101	L	2	CX70.566	L - 184	2			
	H	2		H - 184	2			
CX70.201	L - 44	2	CX70.605					
	H - 44	2						



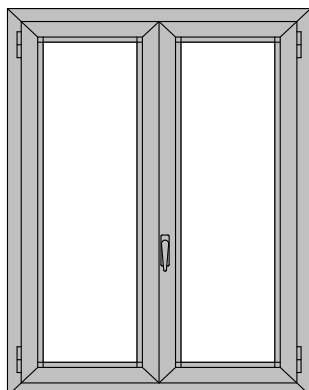

Finestra a 2 ante

Distinta di taglio vetri		
Q.ta	H	L
2	H - 150	L/2 - 132

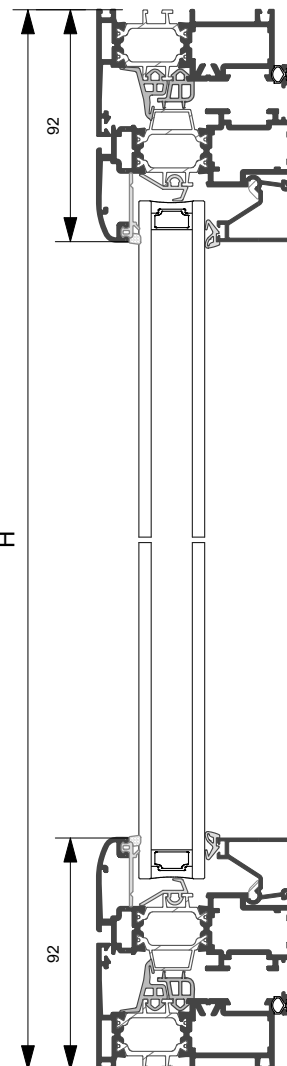
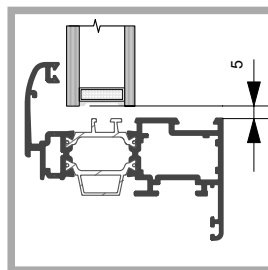

### Accessori e guarnizioni

Codice	Descrizione	Q.ta	Codice	Descrizione	Q.ta
ACX.01.SQ	Squadretta a pulsante	12	ACX.04.01	Tappo riporto centrale	1
ARX.03.SQ	Squadretta cianfrinare est.	12	ARX.05.01	Copriasola scarico acqua	2
ARX.15.SQ	Squadretta allin. telaio/anta	12	ARX.06.01	Espansore	*
ARX.10.SQ	Squadretta allin. anta int.	8	ACX.07.02	Angolo pressof. fermavetro	8
ACX.02.01	Cerniera a 2 ali	4	ARX.10.01	Guarnizione precamera	2L,3H
ARX.03.06	Cremonese pressofusa	1	ACX.10.04	Guarnizione battuta	2L,4H
ACX.03.17	Innesti cremonese	2	ARX.10.05	Guarnizione vetro esterna	2L,4H
ACX.03.18	Teminale astina	2	*	Guarnizione vetro interna	2L,4H
ACX.03.11	Paletto a spinta	2	ARX.10.02	Angolo guarn. precamera	4
ACX.03.14	Ferrogliera	2	ARX.10.11	Guarn. suppl. precamera	2L,3H

\* secondo dimensioni

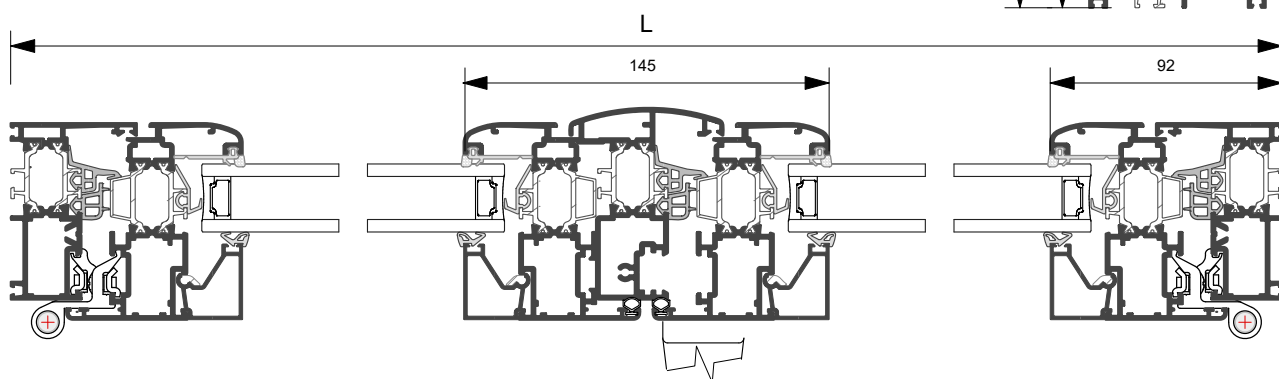

Profilo	Taglio	Q.ta	Profilo	Taglio	Q.ta	Profilo	Taglio	Q.ta
CX70.101	L	2	CX70.566	L/2 - 164.5	4	CX70.605	[Diagram]	
	H	2		H - 184	4			
CX70.201	L/2 - 24.5	4	CX70.301	H - 110	1			
	H - 44	4						

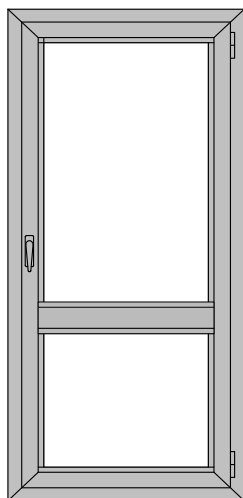

### Porta a 1 anta

Distinta di taglio vetri		
Q.tà	H	L
1	H-HF-58	L -150
1	HF -154	L -150

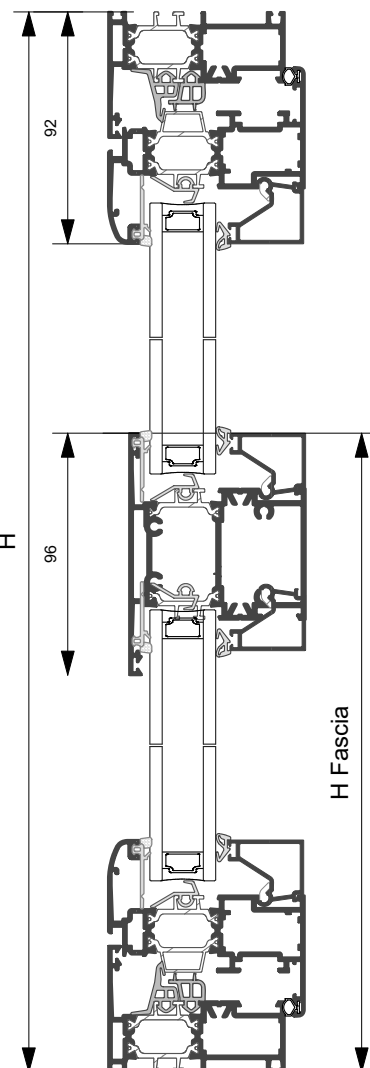
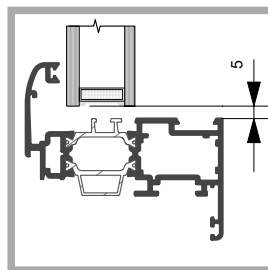

### Accessori e guarnizioni

Codice	Descrizione	Q.ta	Codice	Descrizione	Q.ta
<b>ACX.01.SQ</b>	Squadretta a pulsante	8	<b>ARX.05.01</b>	Copriasola scarico acqua	2
<b>ARX.03.SQ</b>	Squadretta cianfrinare est.	8	<b>ARX.06.01</b>	Espansore	*
<b>ARX.15.SQ</b>	Squadretta allin. telaio/anta	8	<b>ACX.07.02</b>	Angolo pressof. fermavetro	8
<b>ARX.10.SQ</b>	Squadretta allin. anta int.	4	<b>ARX.10.01</b>	Guarnizione precamera	2L,2H
<b>ACX.02.01</b>	Cerniera a 2 ali	3	<b>ACX.10.04</b>	Guarnizione battuta	2L,2H
<b>ARX.03.06</b>	Cremonese pressofusa	1	<b>ARX.10.05</b>	Guarnizione vetro esterna	4L,2H
<b>ACX.03.17</b>	Innesti cremonese	2	*	Guarnizione vetro interna	4L,2H
<b>ACX.03.18</b>	Teminale astina	2	<b>ARX.10.02</b>	Angolo guarn. precamera	4
<b>ACX.03.13</b>	Ferrogliera	2	<b>ARX.10.11</b>	Guarn. suppl. precamera	2L,2H

\* secondo dimensioni

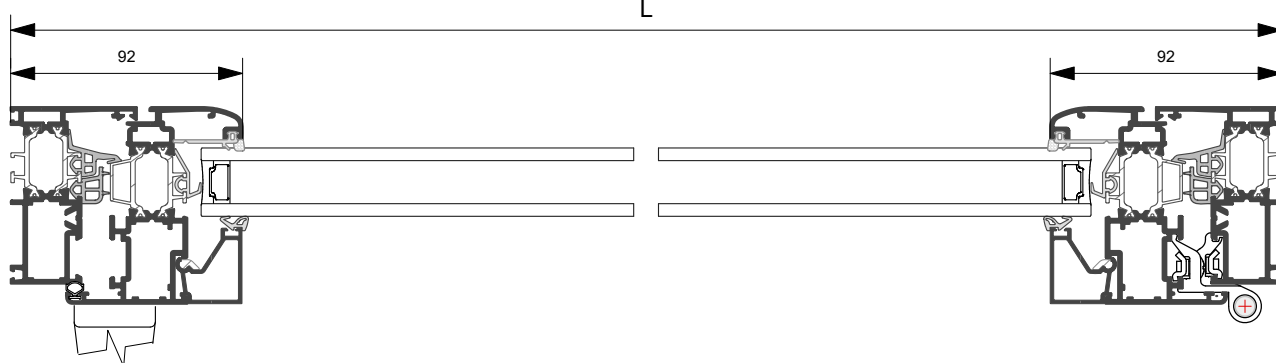

Profilo	Taglio	Q.ta	Profilo	Taglio	Q.ta	Profilo	Taglio	Q.ta
CX70.101	L	2	CX70.566	L - 184	4	CX70.402	L - 130	1
	H	2		H - HF -92	2			
CX70.201	L - 44	2		HF - 188	2			
	H - 44	2	CX70.605					

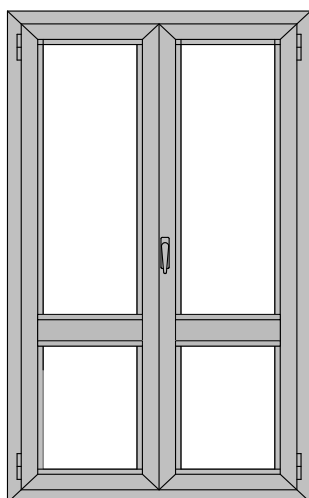

Porta a 2 ante

Distinta di taglio vetri		
Q.tà	H	L
1	H-HF-58	L/2 -130
1	HF -154	L/2 -130

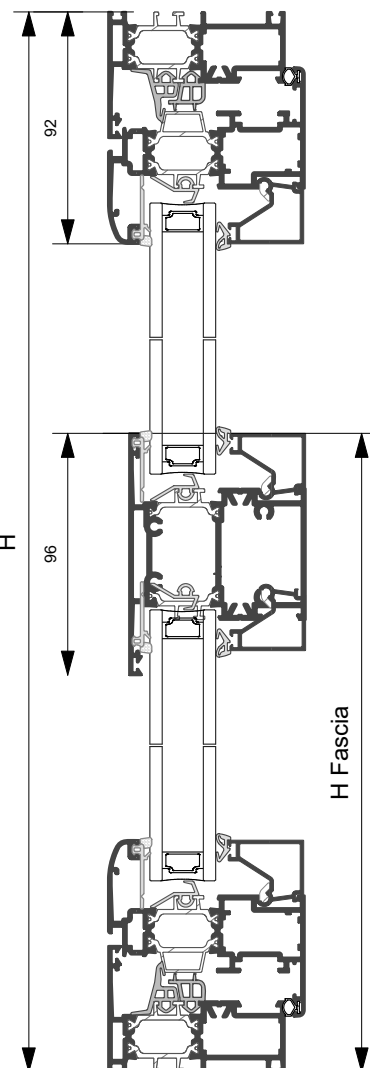
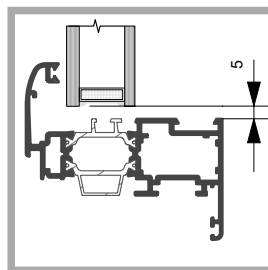

### Accessori e guarnizioni

Codice	Descrizione	Q.ta	Codice	Descrizione	Q.ta
ACX.01.SQ	Squadretta a pulsante	12	ACX.04.01	Tappo riporto centrale	1
ARX.03.SQ	Squadretta cianfrinare est.	12	ARX.05.01	Copriasola scarico acqua	2
ARX.15.SQ	Squadretta allin. telaio/anta	12	ARX.06.01	Espansore	*
ARX.10.SQ	Squadretta allin. anta int.	8	ACX.07.02	Angolo pressof. fermavetro	16
ACX.02.01	Cerniera a 2 ali	6	ARX.10.01	Guarnizione precamera	2L,3H
ARX.03.06	Cremonese pressofusa	1	ACX.10.04	Guarnizione battuta	2L,4H
ACX.03.17	Innesti cremonese	2	ARX.10.05	Guarnizione vetro esterna	4L,4H
ACX.03.18	Teminale astina	2	*	Guarnizione vetro interna	4L,4H
ACX.03.11	Paletto a spinta	2	ARX.10.02	Angolo guarn. precamera	4
ACX.03.14	Ferrogliera	2	ARX.10.11	Guarn. suppl. precamera	2L,3H

\* secondo dimensioni

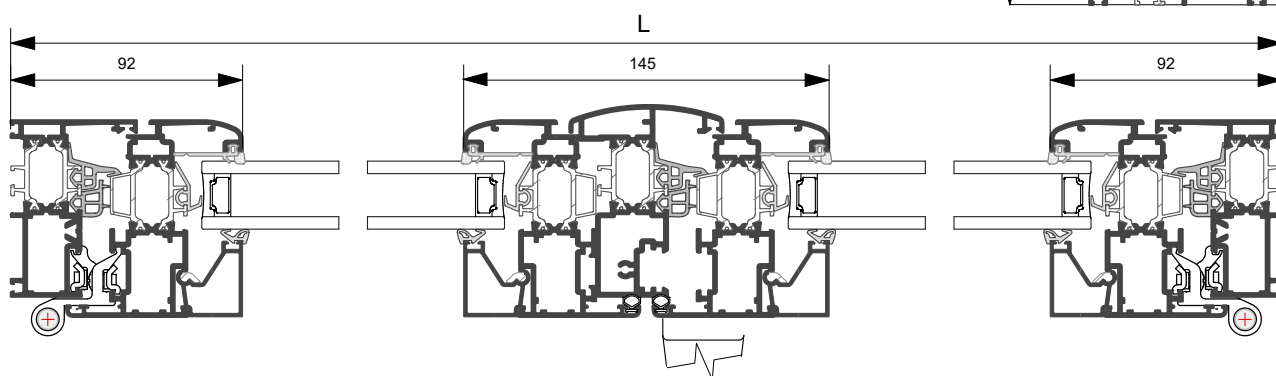

Profilo	Taglio	Q.ta	Profilo	Taglio	Q.ta	Profilo	Taglio	Q.ta
CX70.101	L	2	CX70.566	L/2 - 164.5	8	CX70.301	H - 110	1
	H	2		H - HF -92	4			
CX70.201	L/2 - 24.5	4		HF - 188	4	CX70.402	L/2 - 110.5	2
	H - 44	2	CX70.605		1			



Collegamento muratura

Gruppo **F**

Sezione particolareggiata  
attacco alla muratura





## FISSAGGIO ALLA MURATURA

<b>ARX.06.01</b>	
Descrizione	
<b>Registro Universale</b>	

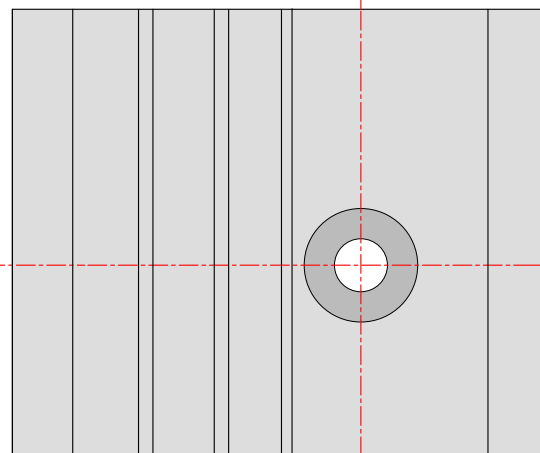
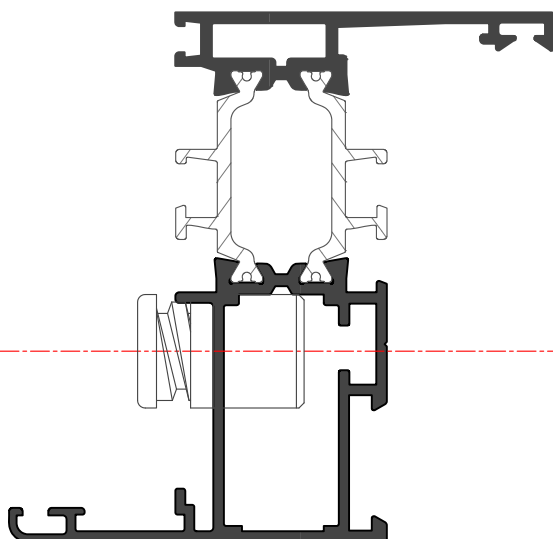
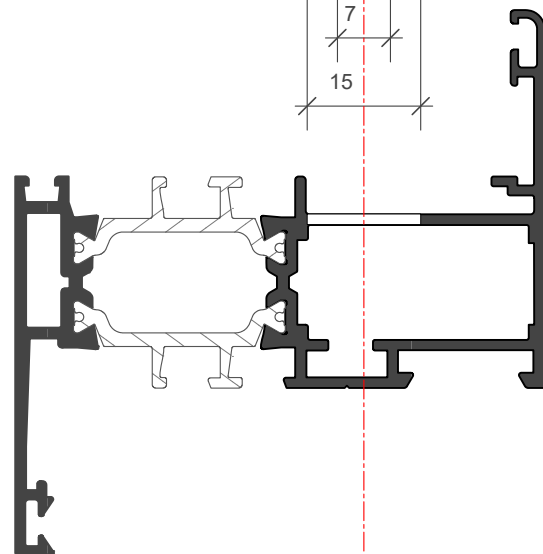
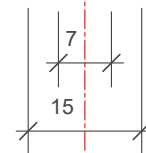
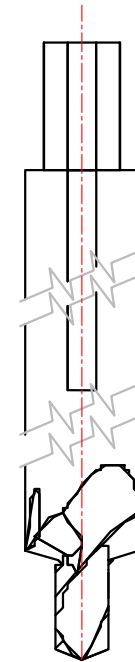



## FISSAGGIO ALLA MURATURA

Schiuma flessibile  
permeabile al vapore  
tipo **FLEXIFOAM**

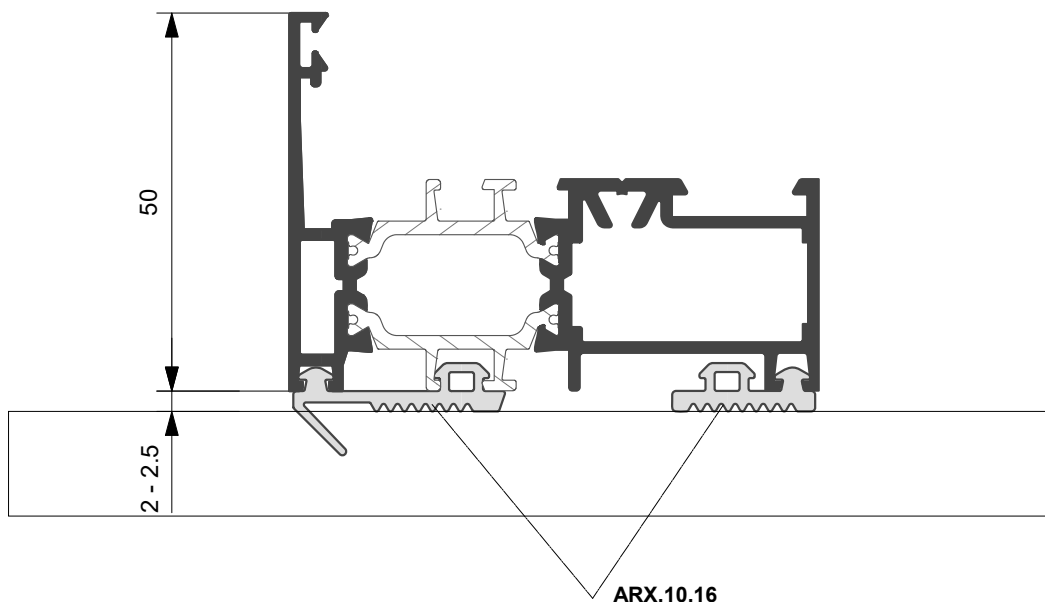
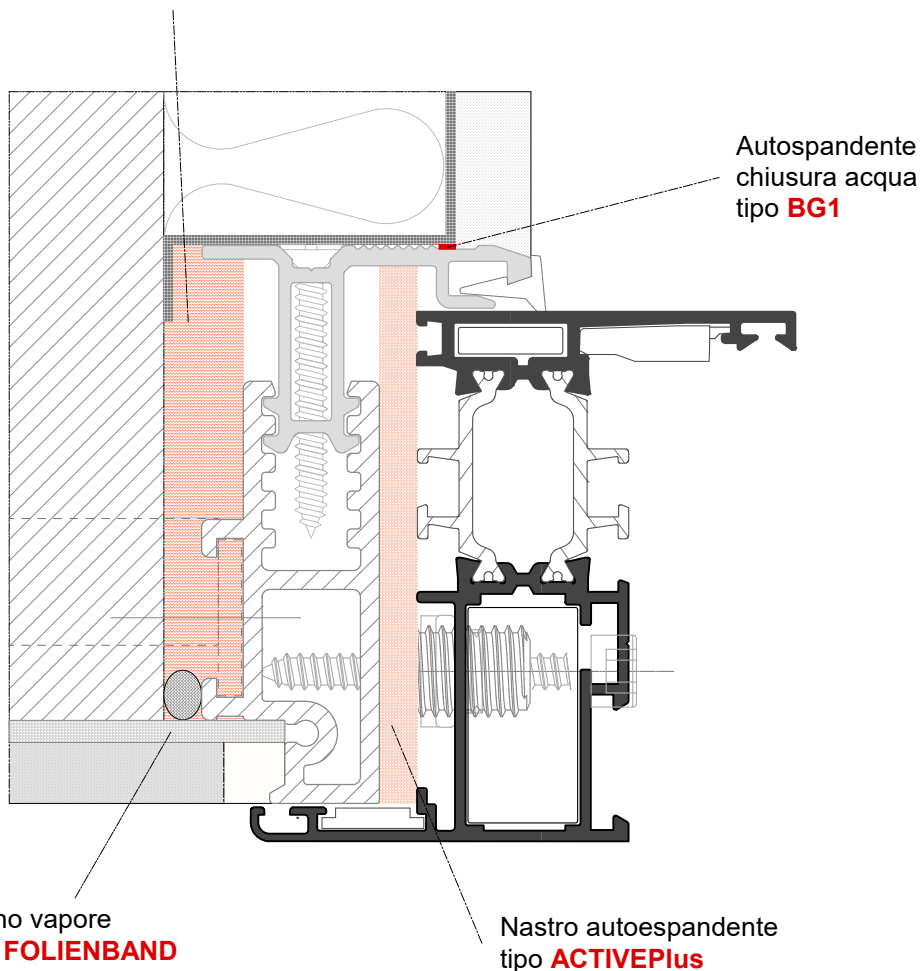



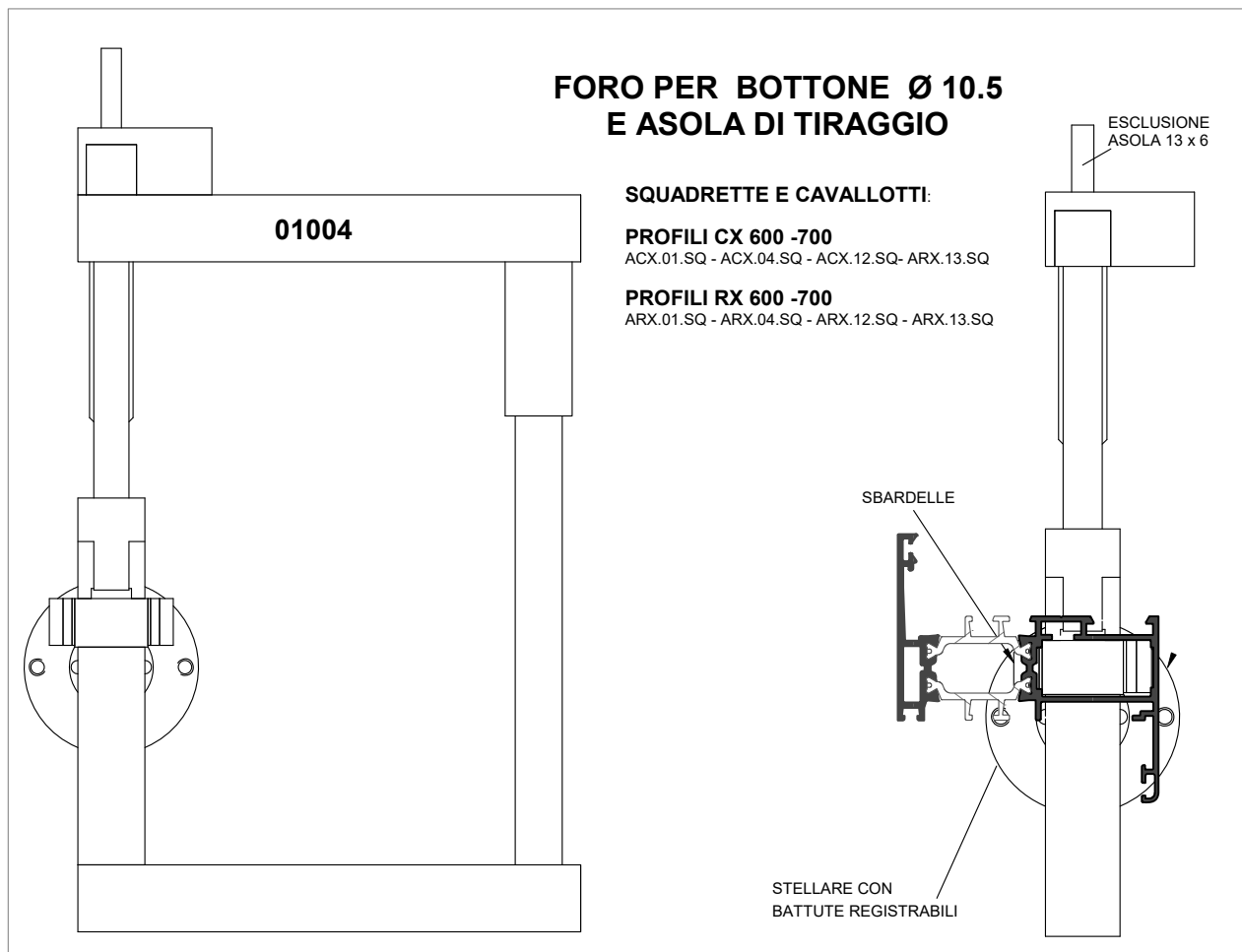
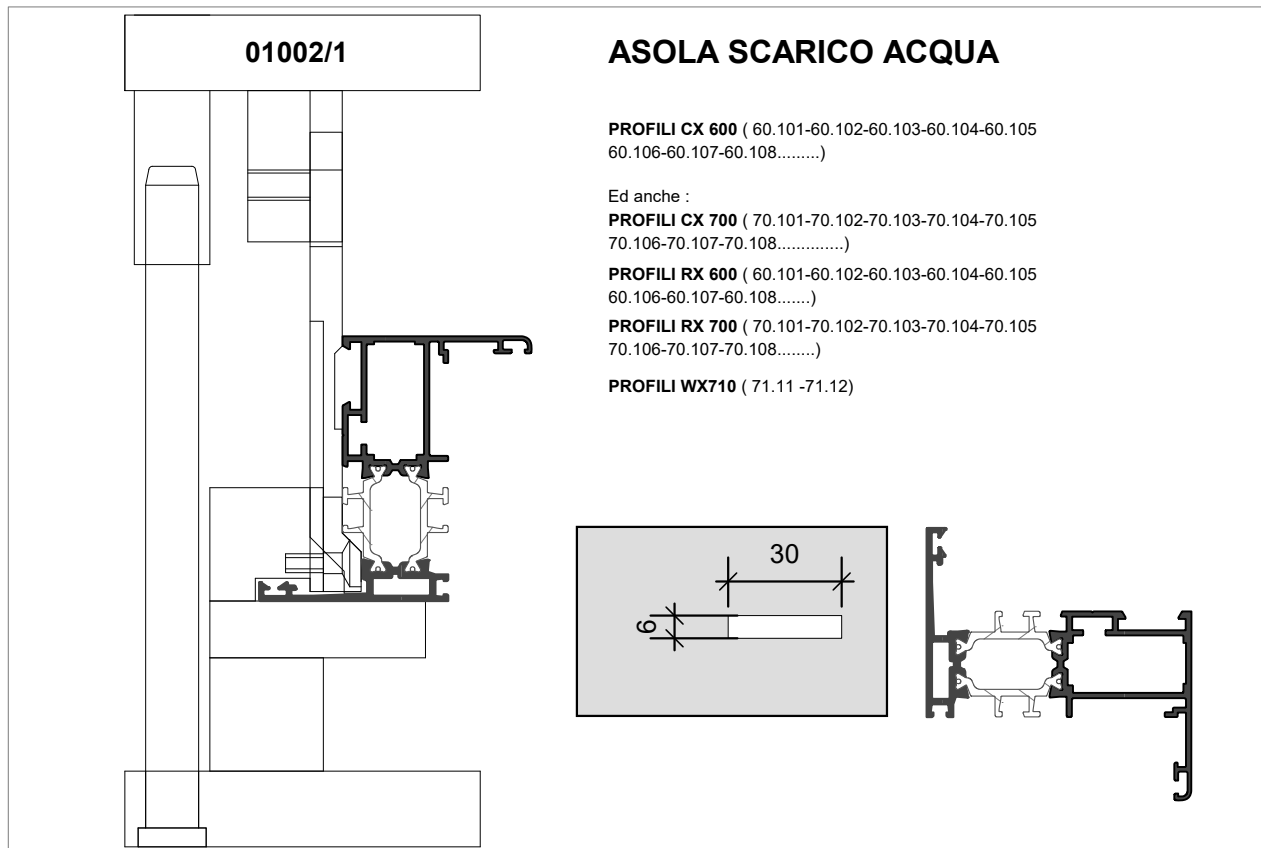



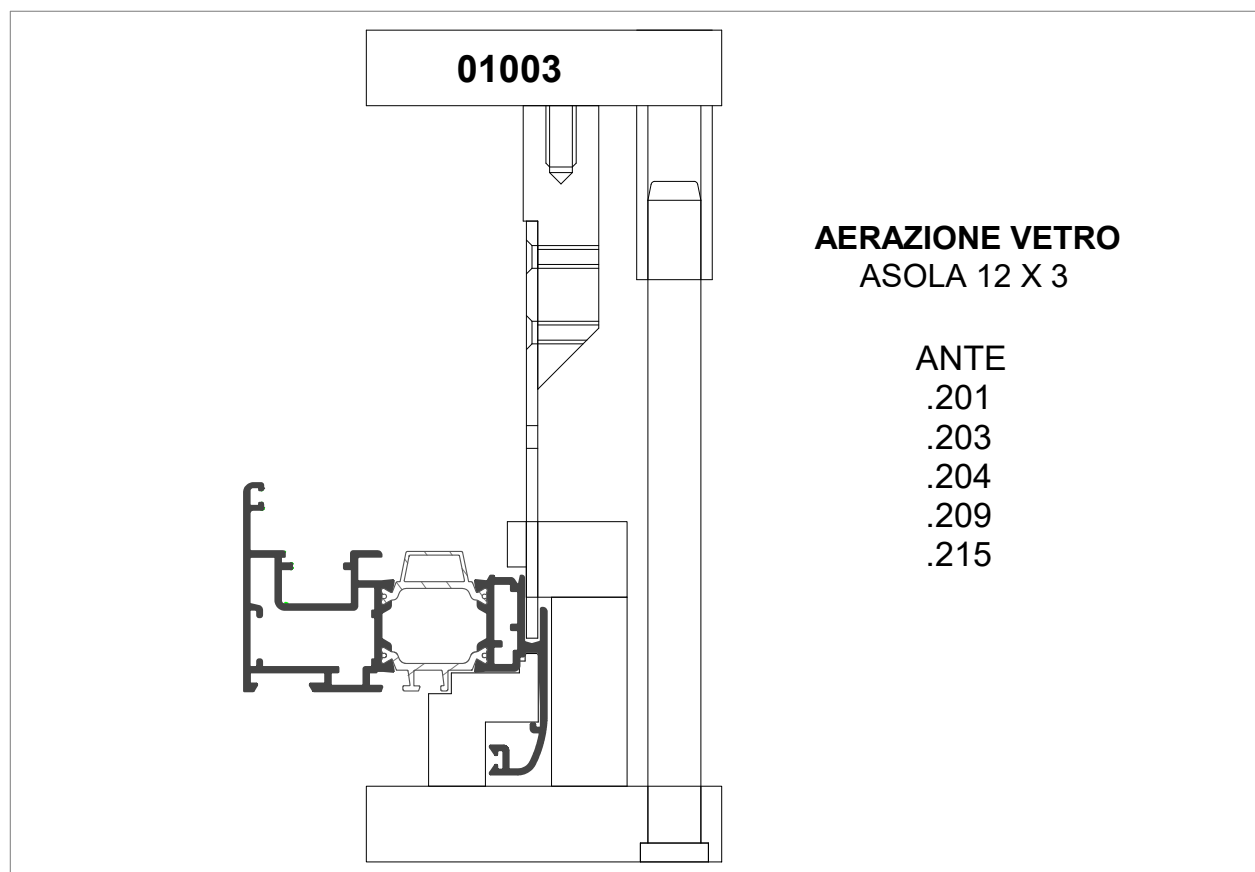
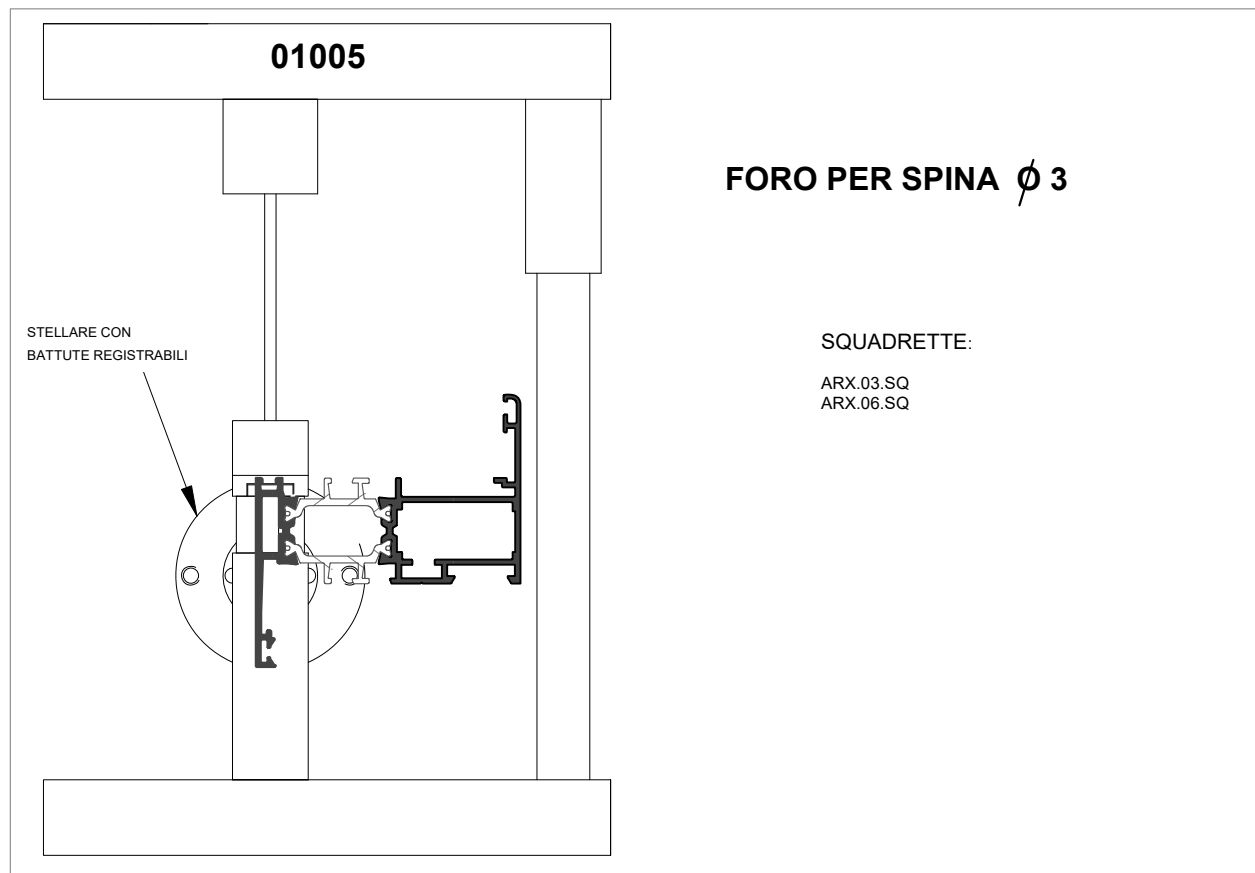

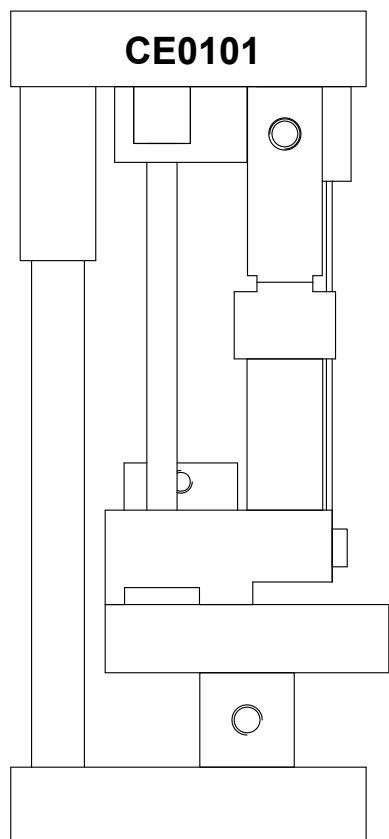

### LAVORAZIONI

- LAVORAZIONE CREMONESE DA 104mm
- FORO Ø8 DI TESTA E PASSANTE, DOPPIO FORO DA Ø8 SU ASTINA
- ASPORTAZIONE DENTINI PASSAGGIO ASTA

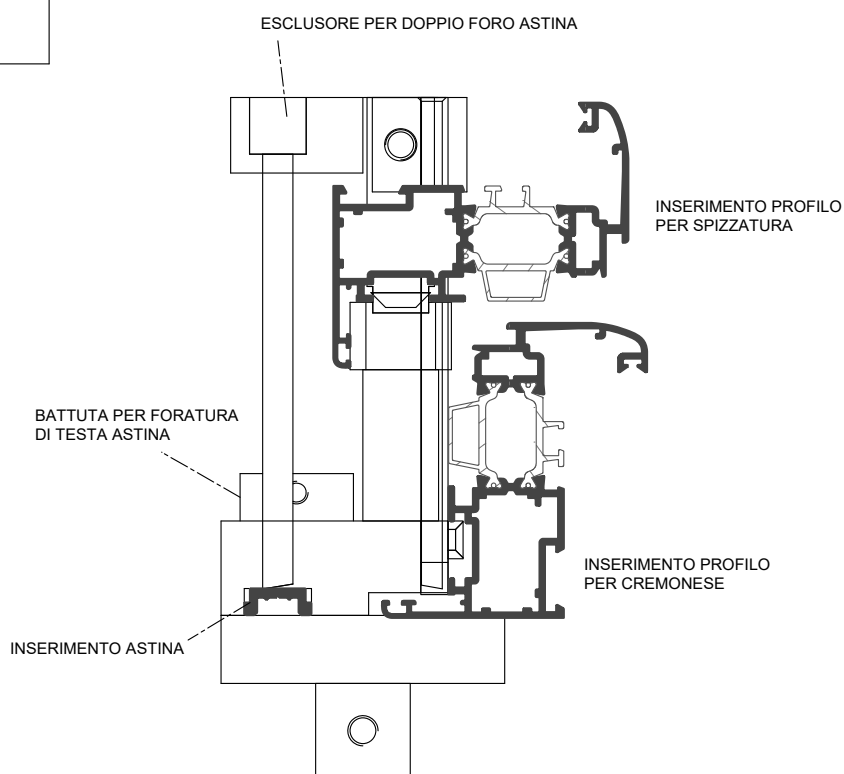

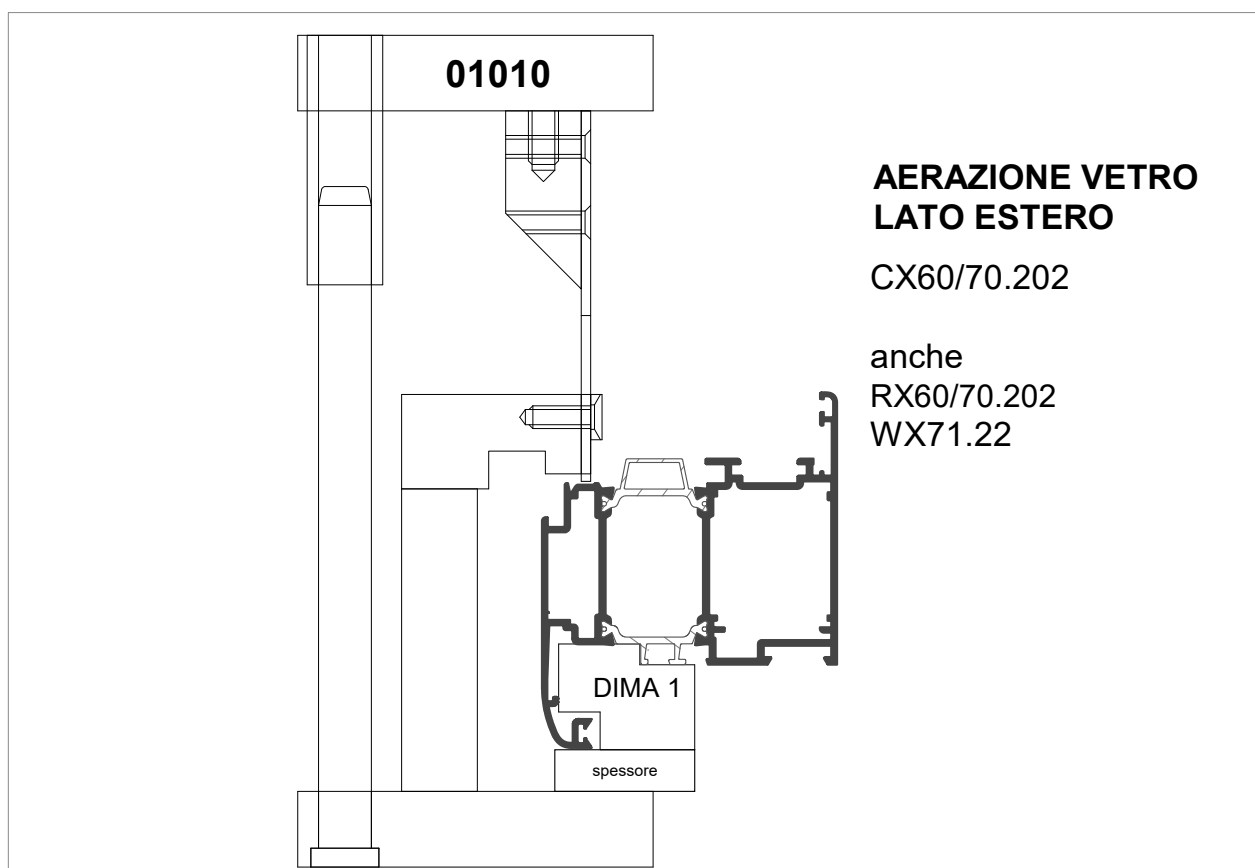
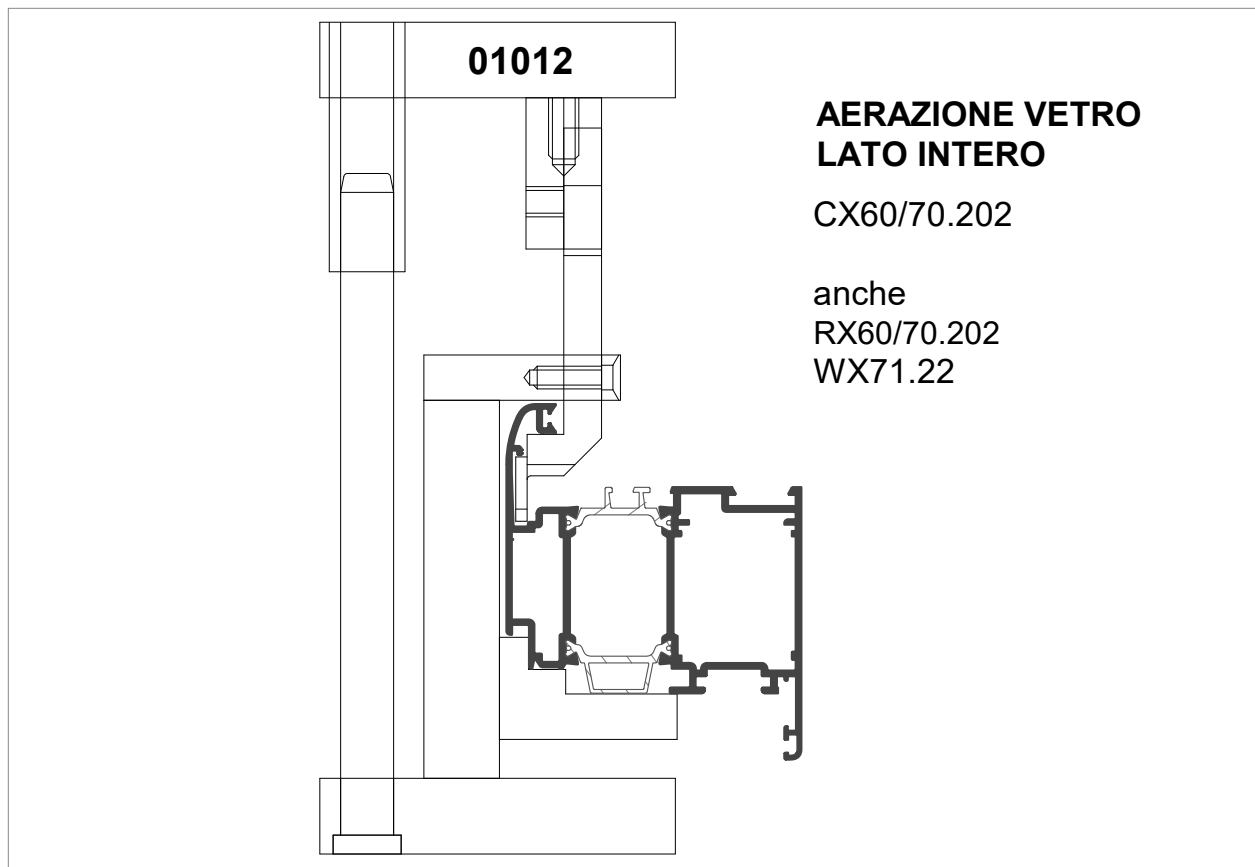

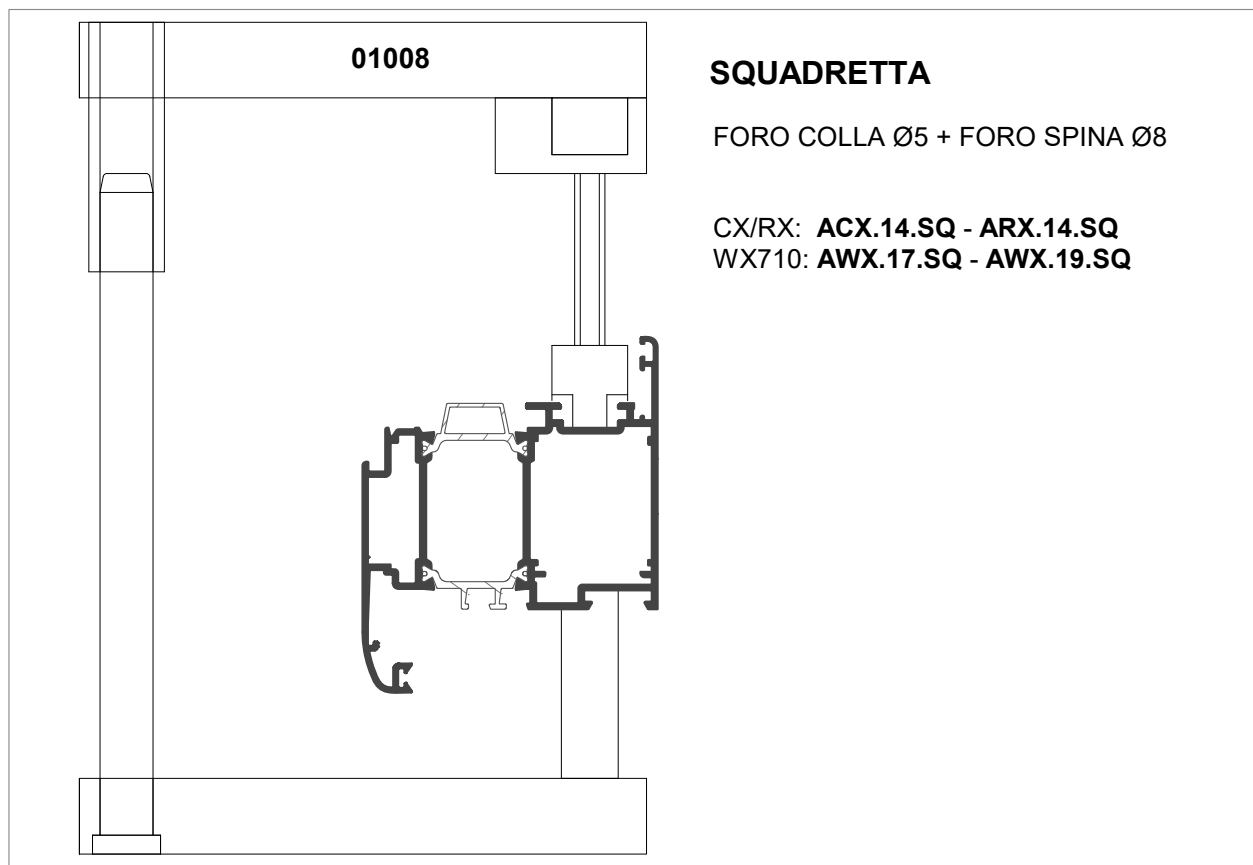

**SQUADRETTA**

FORO COLLA Ø5 + FORO SPINA Ø8

CX/RX: **ACX.14.SQ - ARX.14.SQ**  
WX710: **AWX.17.SQ - AWX.19.SQ**

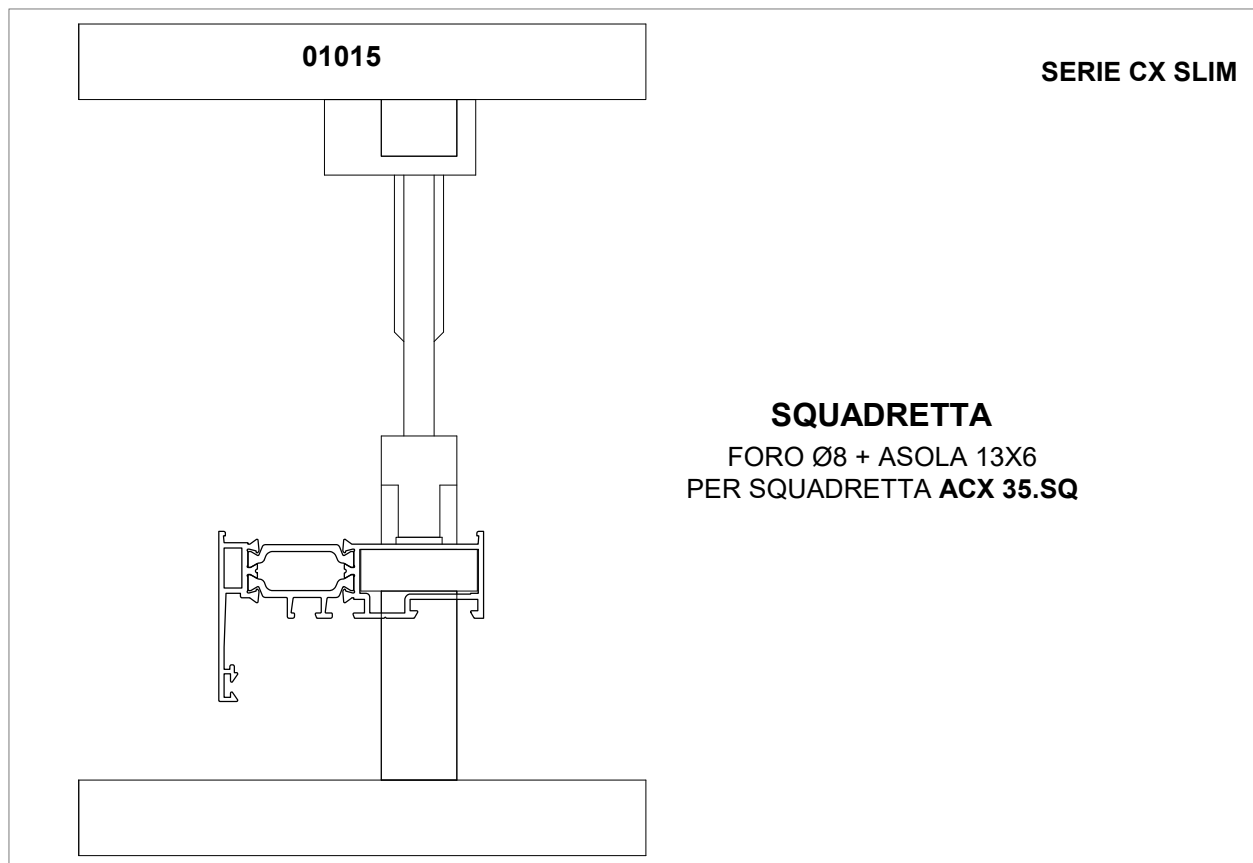

**SERIE CX SLIM**

**SQUADRETTA**

FORO Ø8 + ASOLA 13X6  
PER SQUADRETTA **ACX 35.SQ**

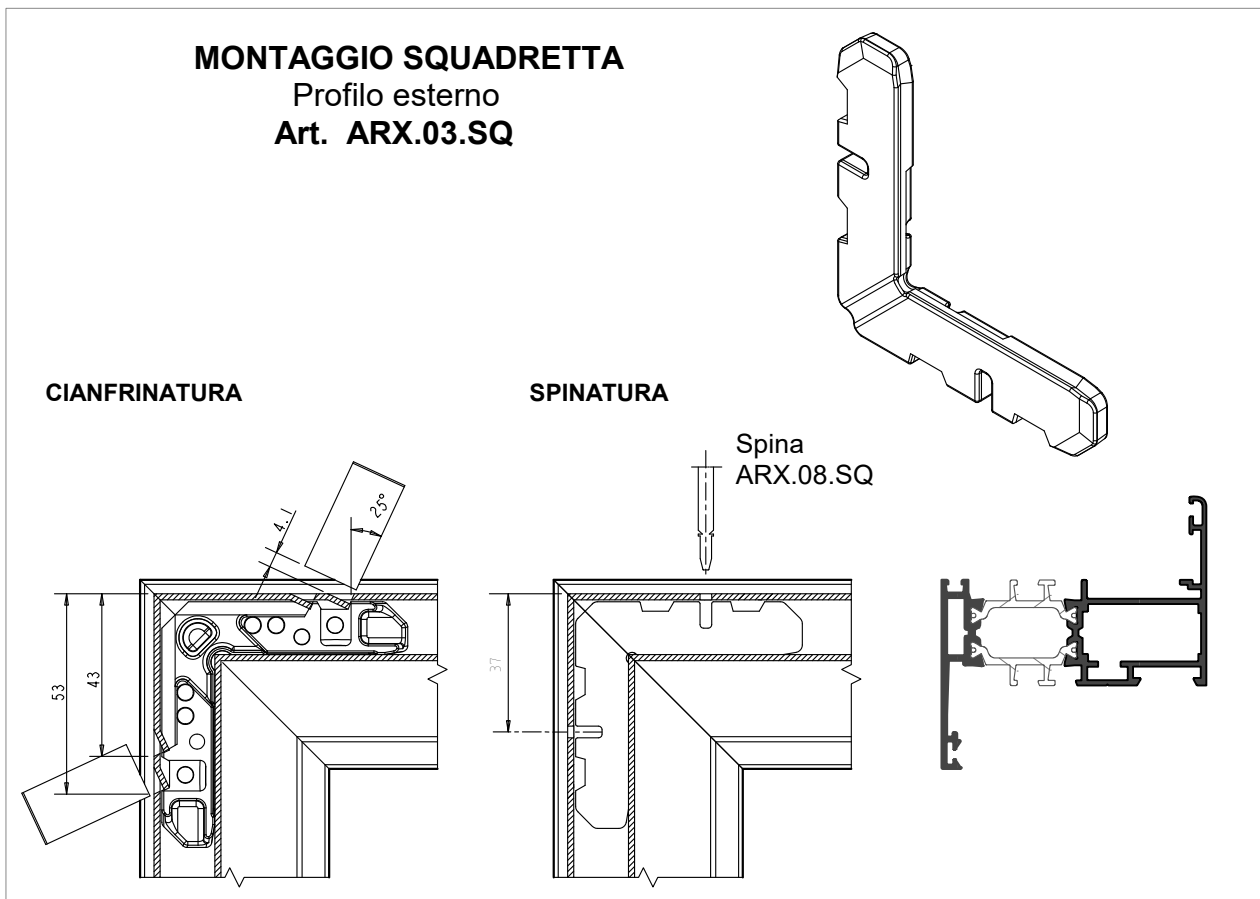
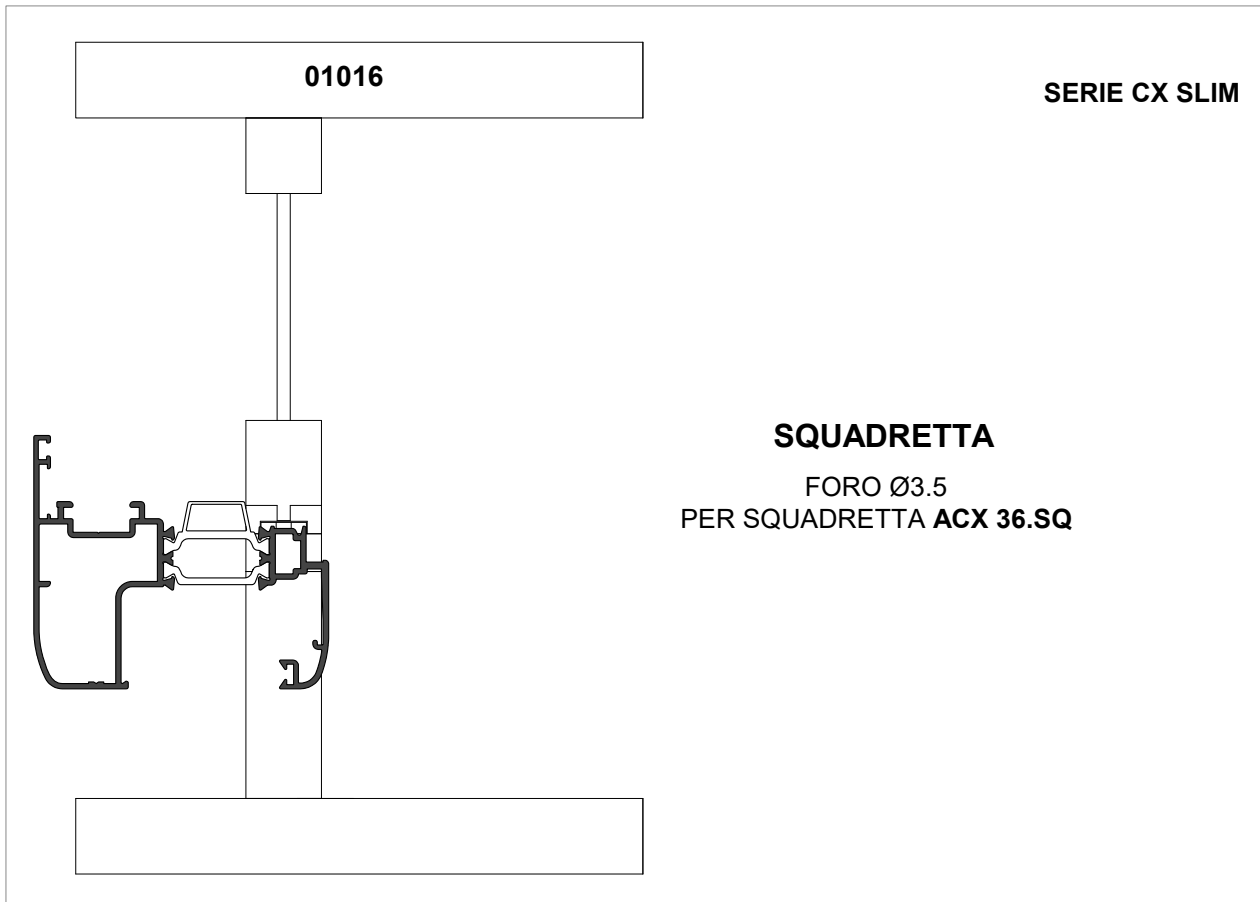



### MONTAGGIO SQUADRETTA

Profilo esterno  
Art. ARX.06.SQ

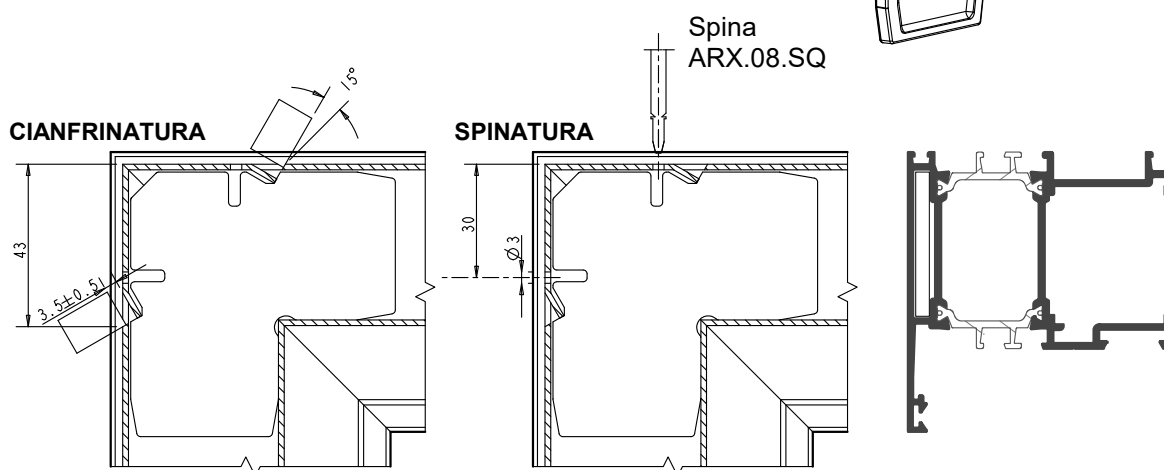
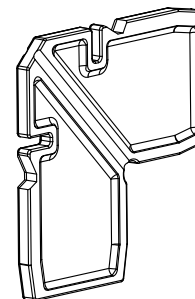

### MONTAGGIO SQUADRETTA A PULSANTE

Profilo interno  
Art. ACX.01.SQ

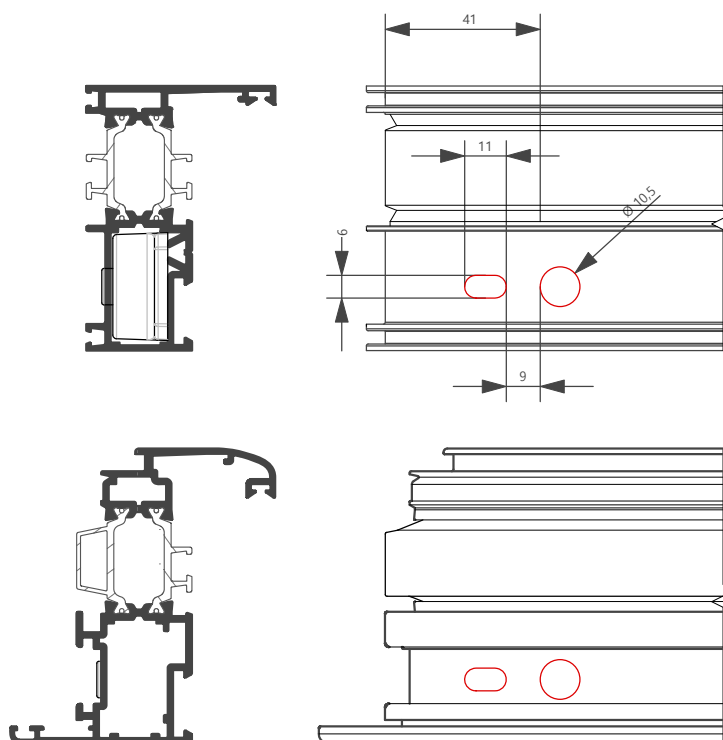
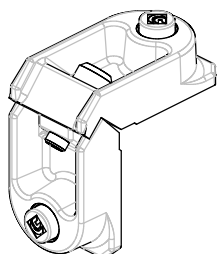



**MONTAGGIO SQUADRETTA A PULSANTE**

Profilo interno  
**Art. ARX.13.SQ**

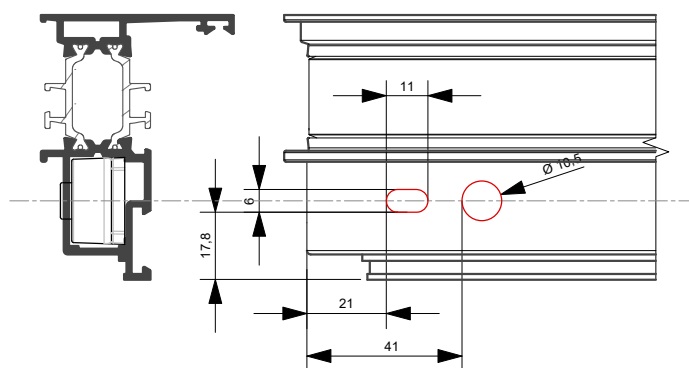
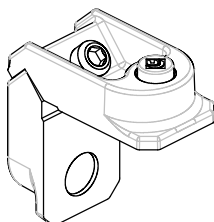

**MONTAGGIO SQUADRETTA A PULSANTE**

Profilo interno  
**Art. ACX.04.SQ** ( Destra e Sinistra)

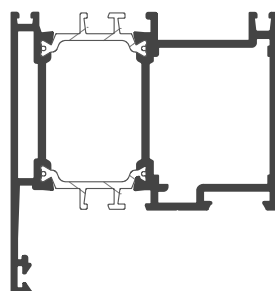
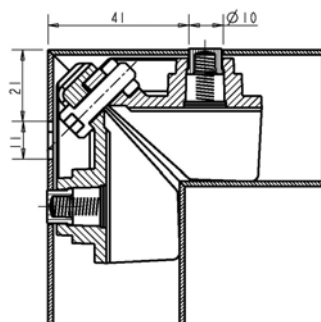
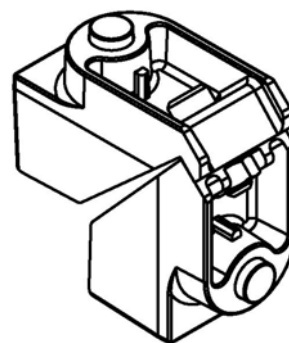

PROFILI :  
.105 - .202 e similari

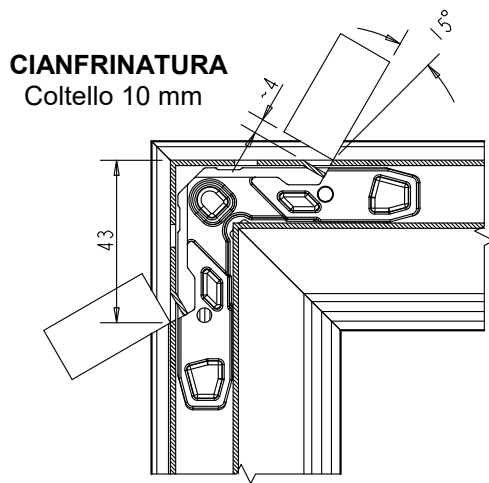

**MONTAGGIO SQUADRETTA  
SPINARE, CIANFRINARE ED AVVITARE**

Art. ACX.02.SQ

**AVVITATURA**  
VIL M5X14\_D8

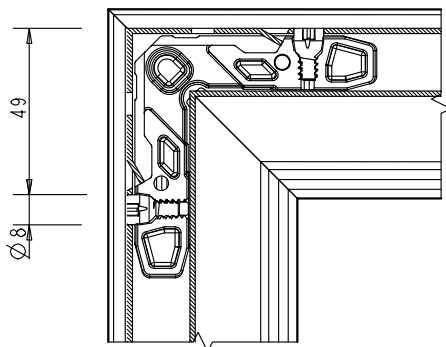

**SPINATURA**  
SPINA 0088

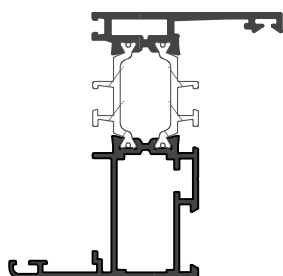
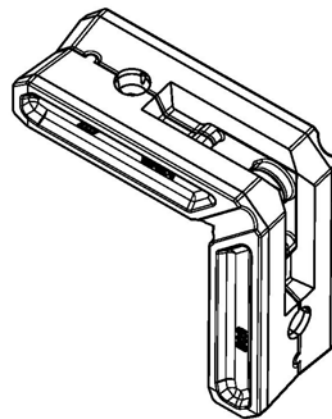
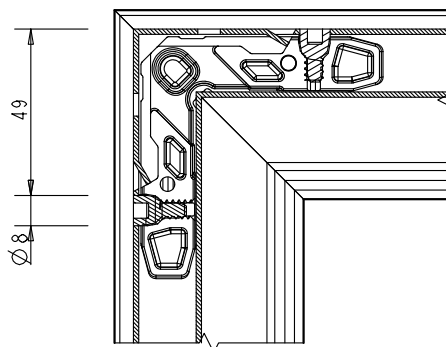

PROFILI :  
.101 - .201 e similari





**SPINATURA**  
SPINA 0088

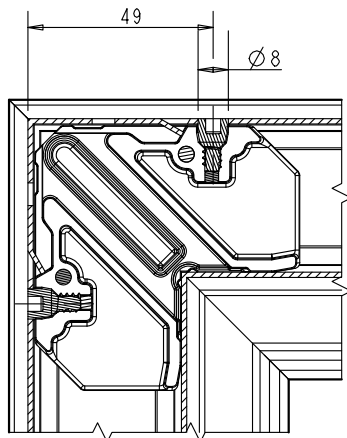

**MONTAGGIO SQUADRETTA  
SPINARE, CIANFRINARE ED AVVITARE**

**Art. ACX.14.SQ**

**AVVITATURA**  
VIL M5X14\_D8

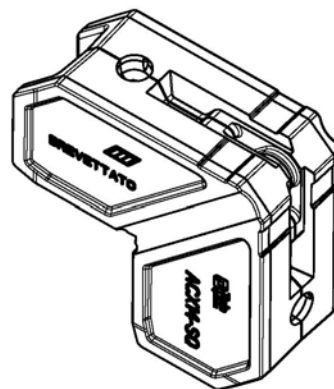
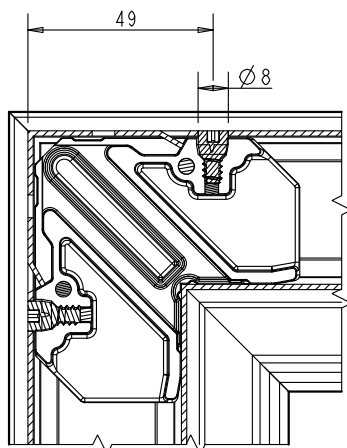

**CIANFRINATURA**  
Coltello 10 mm

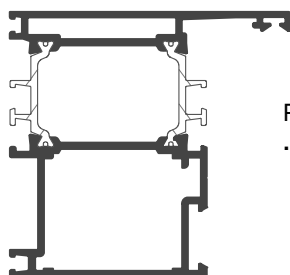
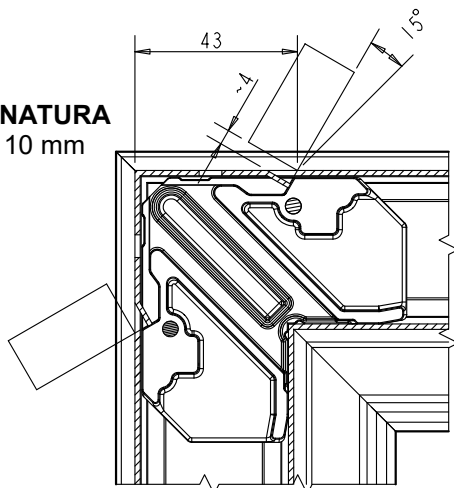

**PROFILI :**  
.105 - .202 e similari



**APPLICAZIONE ACCESSORI**

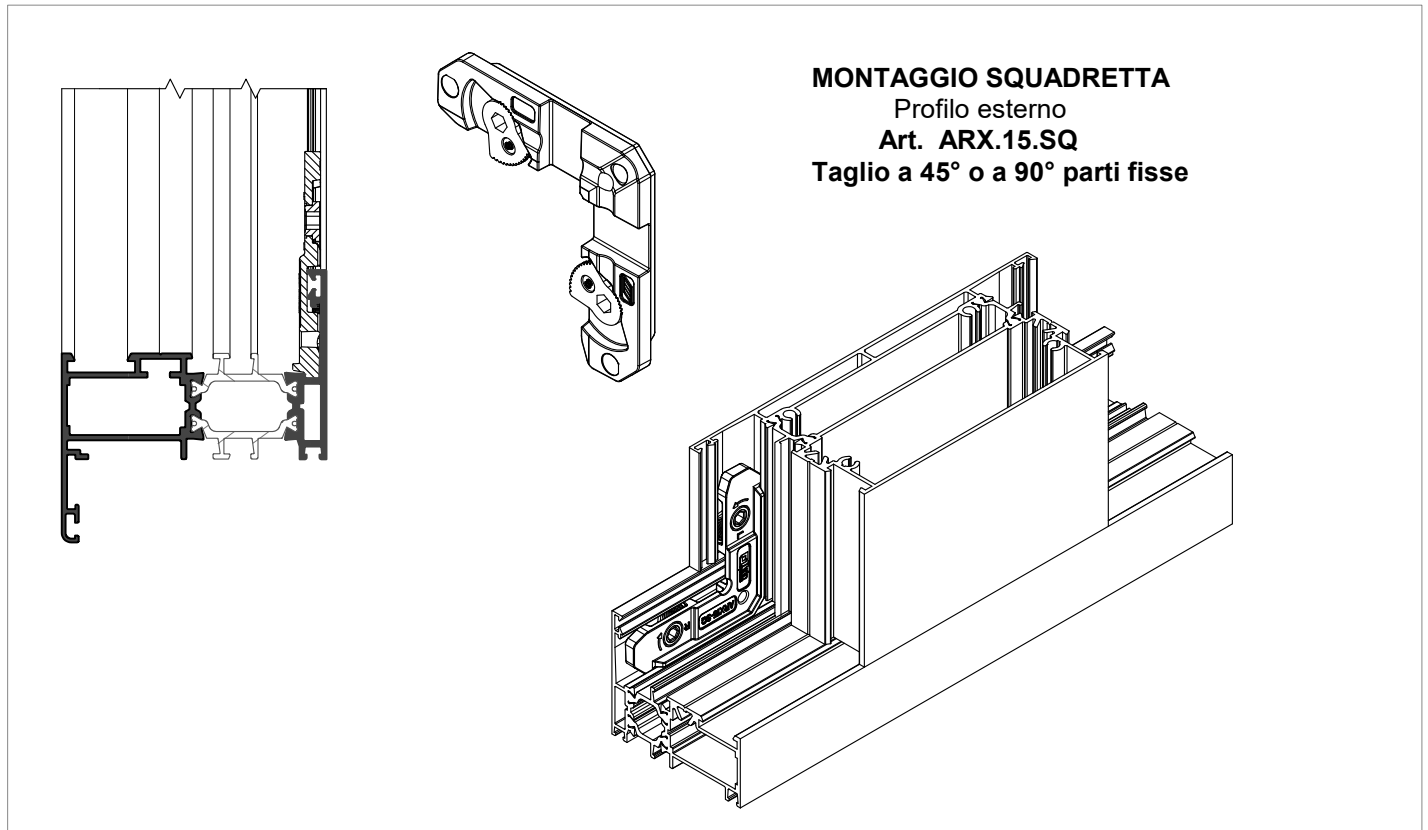

**APPLICAZIONE ACCESSORI**

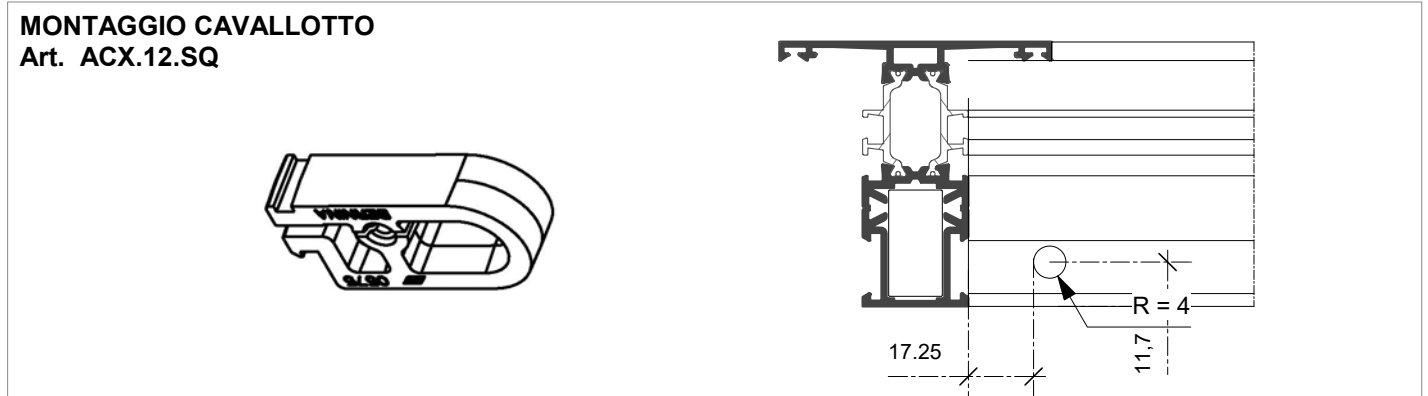

**APPLICAZIONE ACCESSORI**

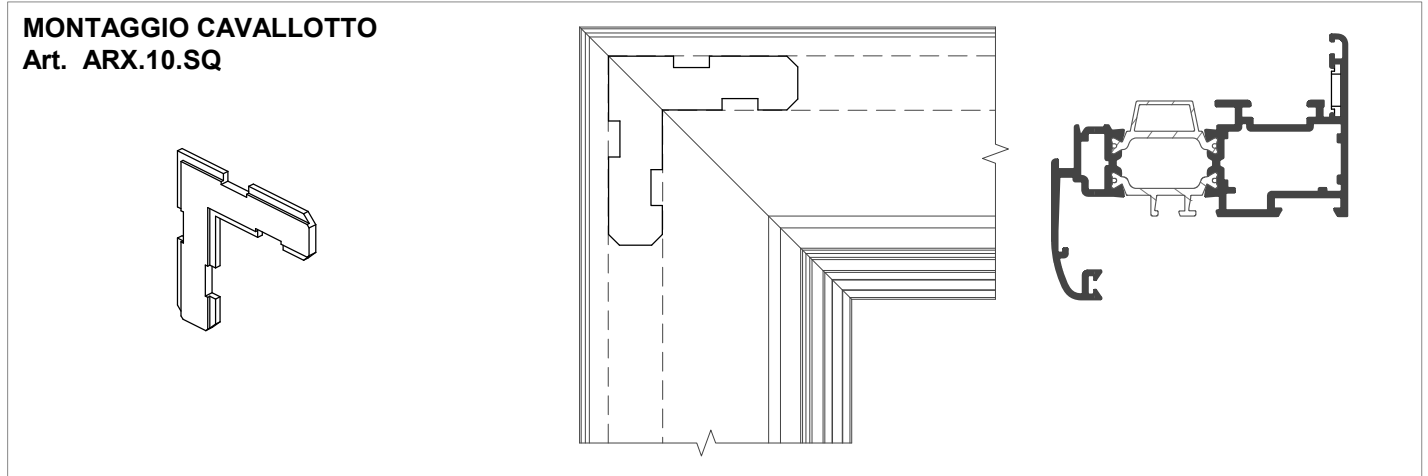



**APPLICAZIONE ACCESSORI**

**MONTAGGIO SQUADRETTA**  
Art. ARX.11.SQ

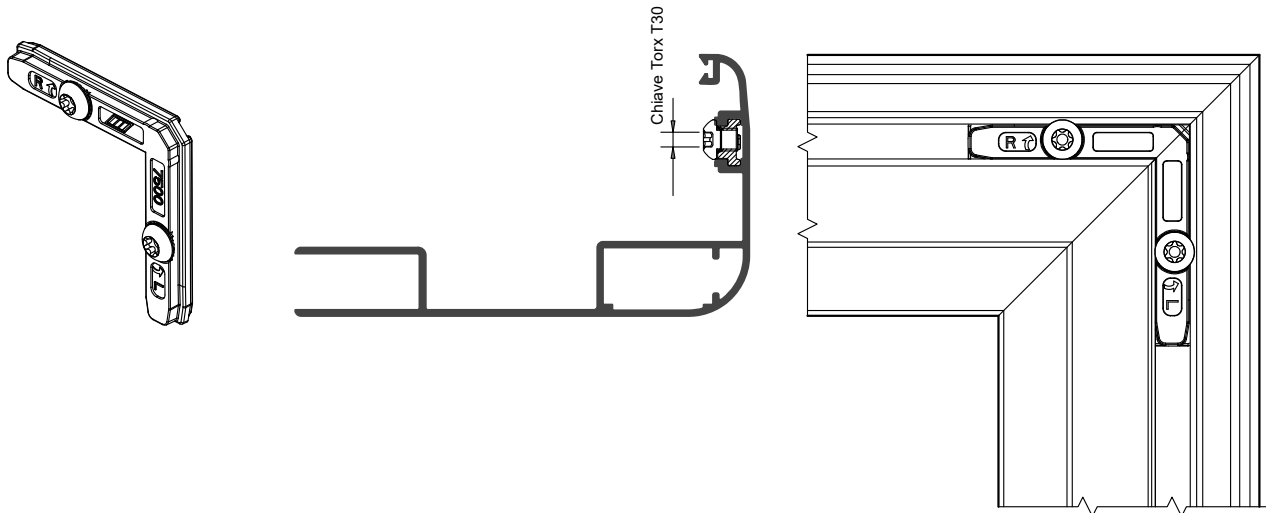

**APPLICAZIONE ACCESSORI**

**MONTAGGIO SQUADRETTA**  
**IN NYLON**

**Art. ARX.24.SQ**  
(alternativa alla ARX.15.SQ)

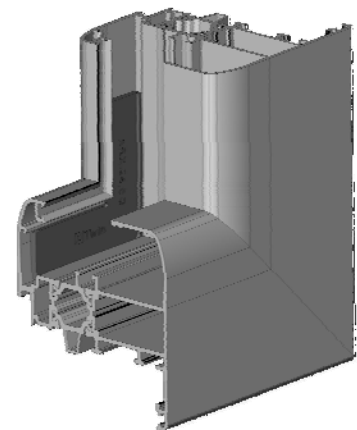

**APPLICAZIONE ACCESSORI**

**GIUNTO PER VETRO AD INFILARE**  
(Fascia taglio a 90°)  
**Art. ACX.04.20**

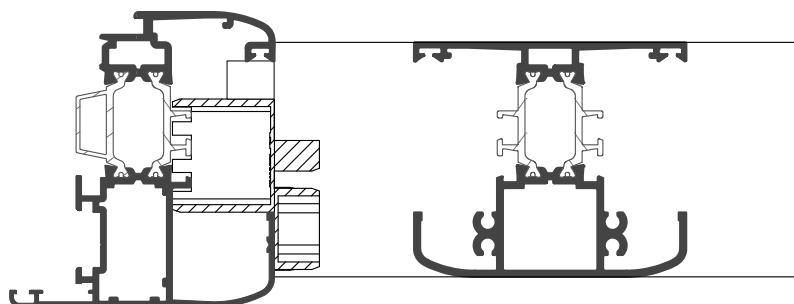



**APPLICAZIONE ACCESSORI**

**ACX.03.12**  
Terminale asta

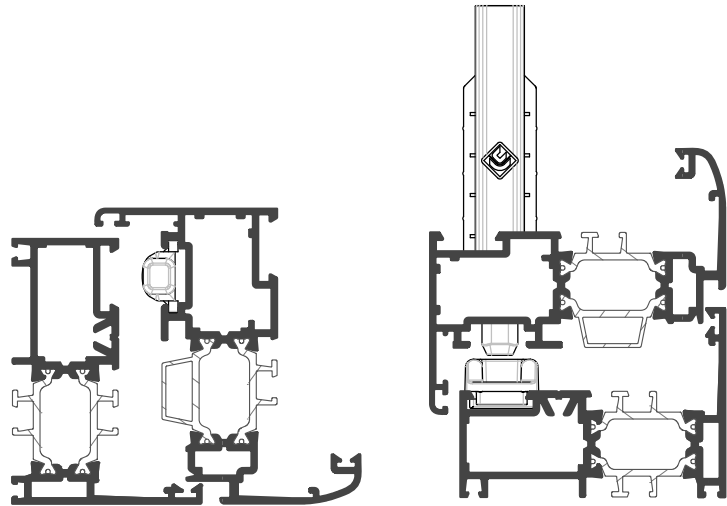
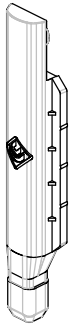

**APPLICAZIONE ACCESSORI**

**ACX.03.18**  
Terminale asta in zama

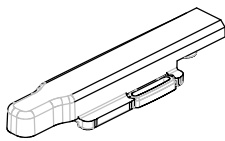

**ACX.08.13**  
Incontro asta  
singolo in zama

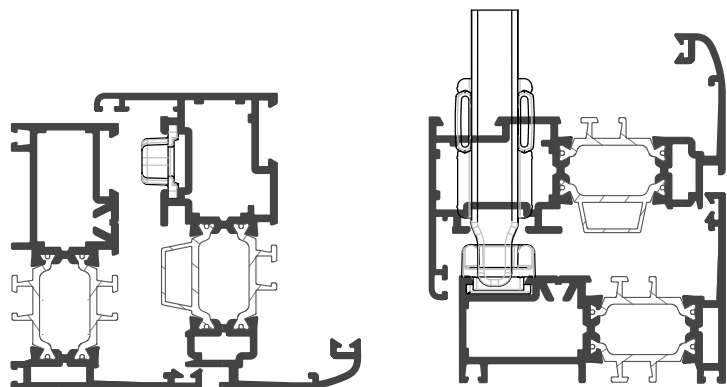
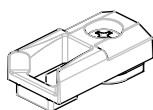



**APPLICAZIONE ACCESSORI**

**ACX.03.11**  
Catenaccio a leva

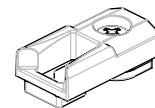
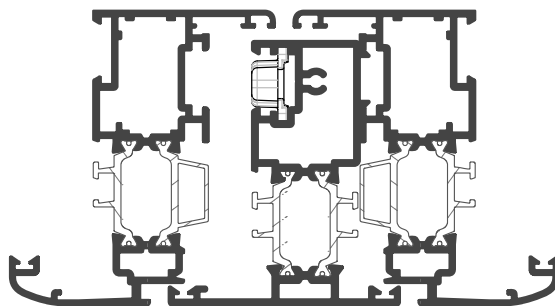
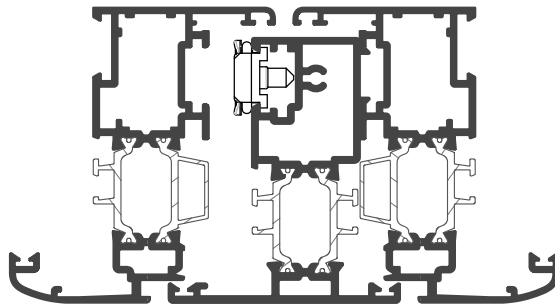
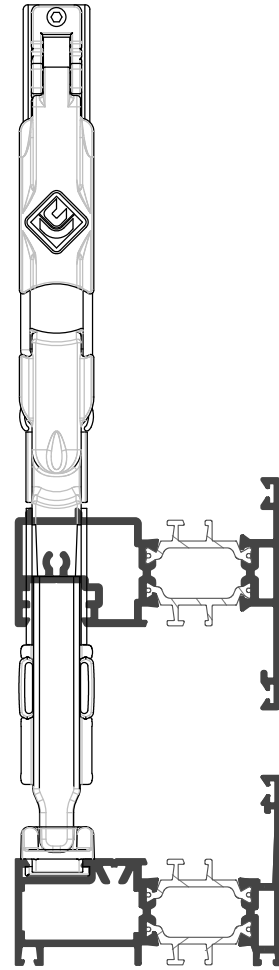
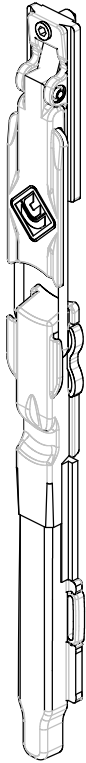

**ACX.08.13**  
Incontro asta



**APPLICAZIONE ACCESSORI**

**ACX.03.16**  
Kit di chiusura  
supplementare  
con eccentrico

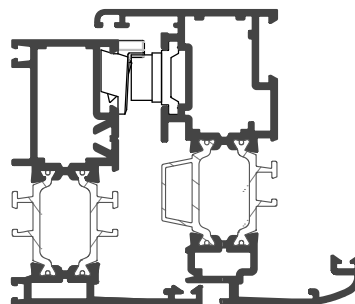
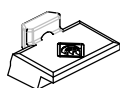

**APPLICAZIONE ACCESSORI**

**ACX.03.63**  
Incontro a pozzetto d = 8 mm.

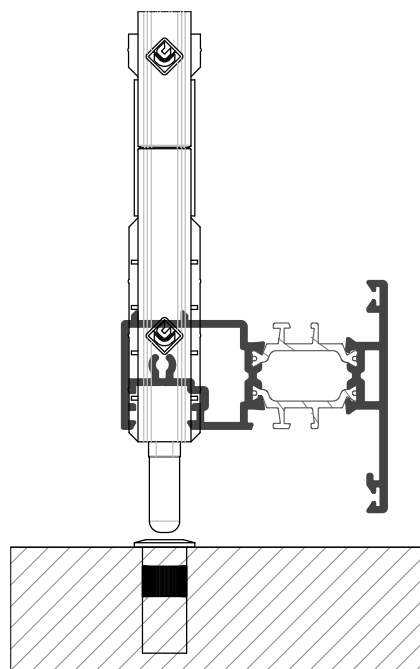
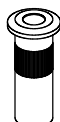



**APPLICAZIONE ACCESSORI**

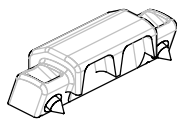

**ACX.03.19**  
Kit sostegno anta

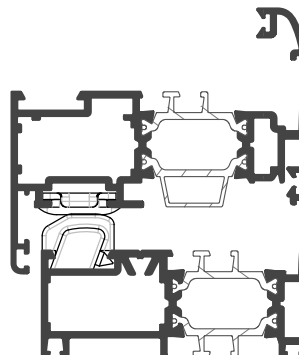
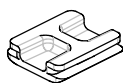

**APPLICAZIONE ACCESSORI**

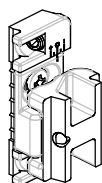

**ACX.03.29**  
Rostro regolabile

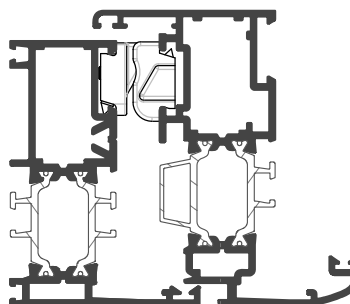

**APPLICAZIONE ACCESSORI**

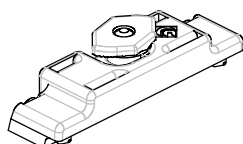

**ACX.03.15**  
Clip ferma anta

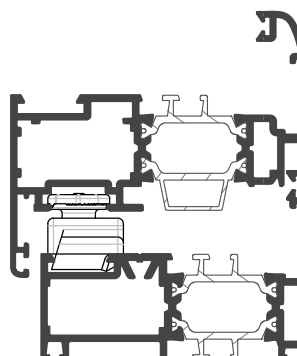



**APPLICAZIONE ACCESSORI**

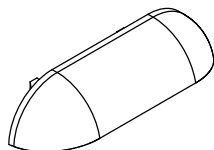

**ARX.05.01**  
Cappetta drenaggio

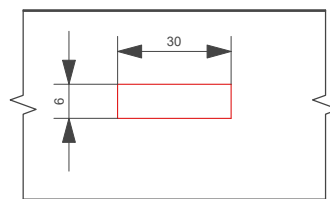
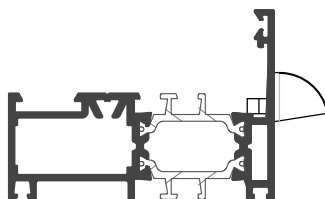

**APPLICAZIONE ACCESSORI**



**ARX.06.02**  
Piastrina registro telaio



**ARX.06.03**  
Registro telaio mm.20

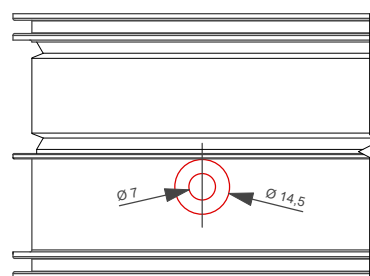
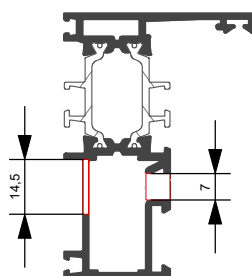
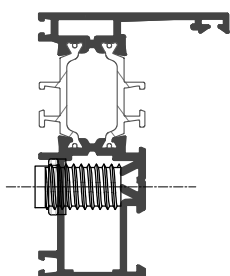

**APPLICAZIONE ACCESSORI**

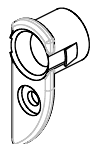

**ARX.06.01**  
Registro telaio universale

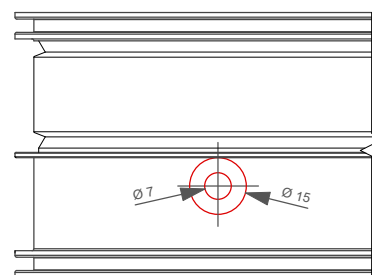
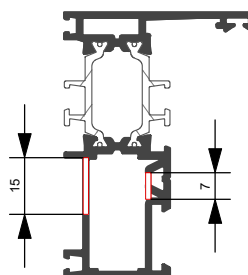
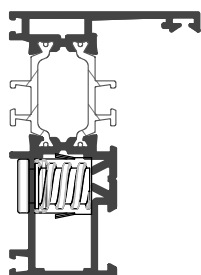





**APPLICAZIONE ACCESSORI**

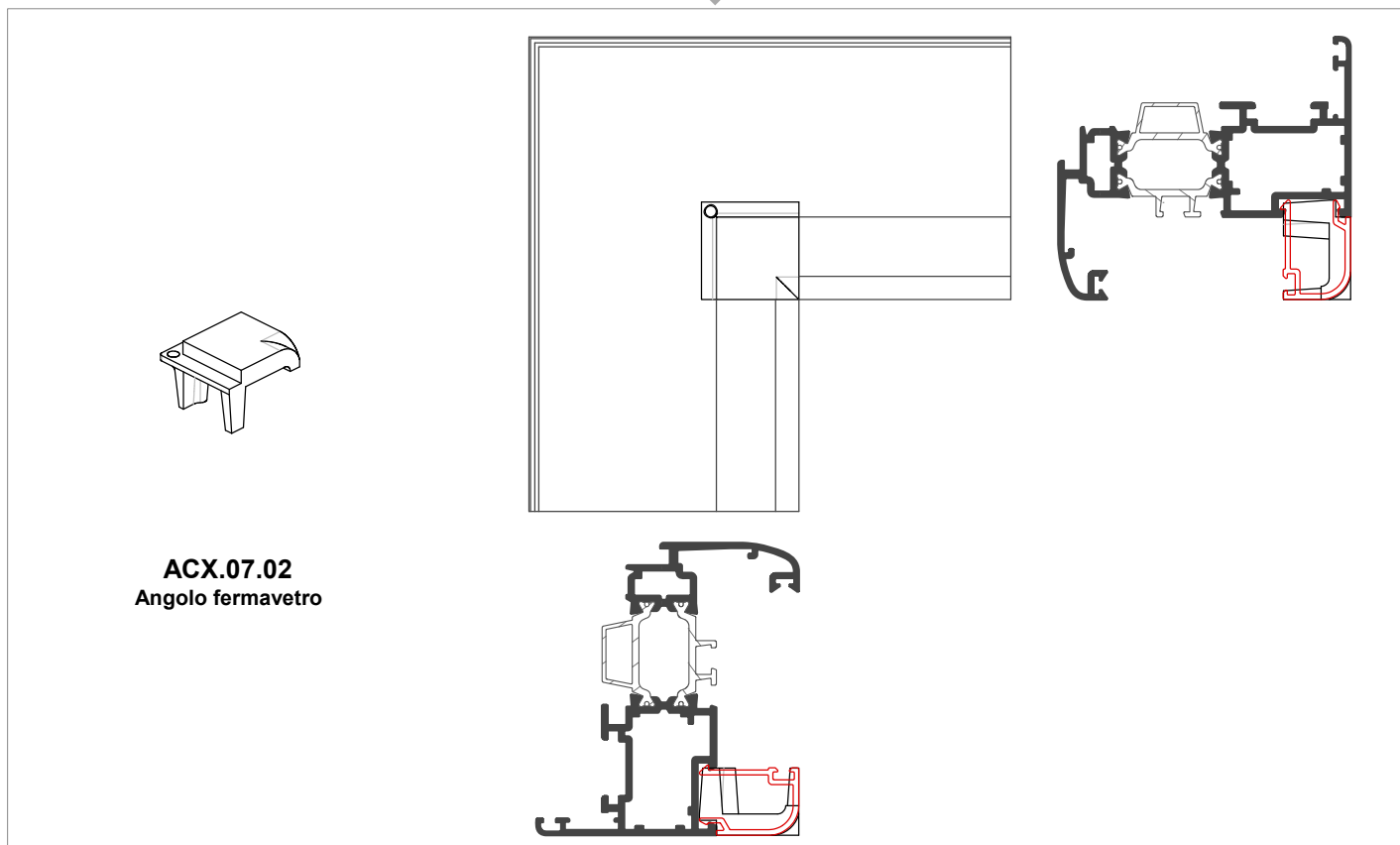

**ACX.07.02**  
Angolo fermavetro

**APPLICAZIONE ACCESSORI**

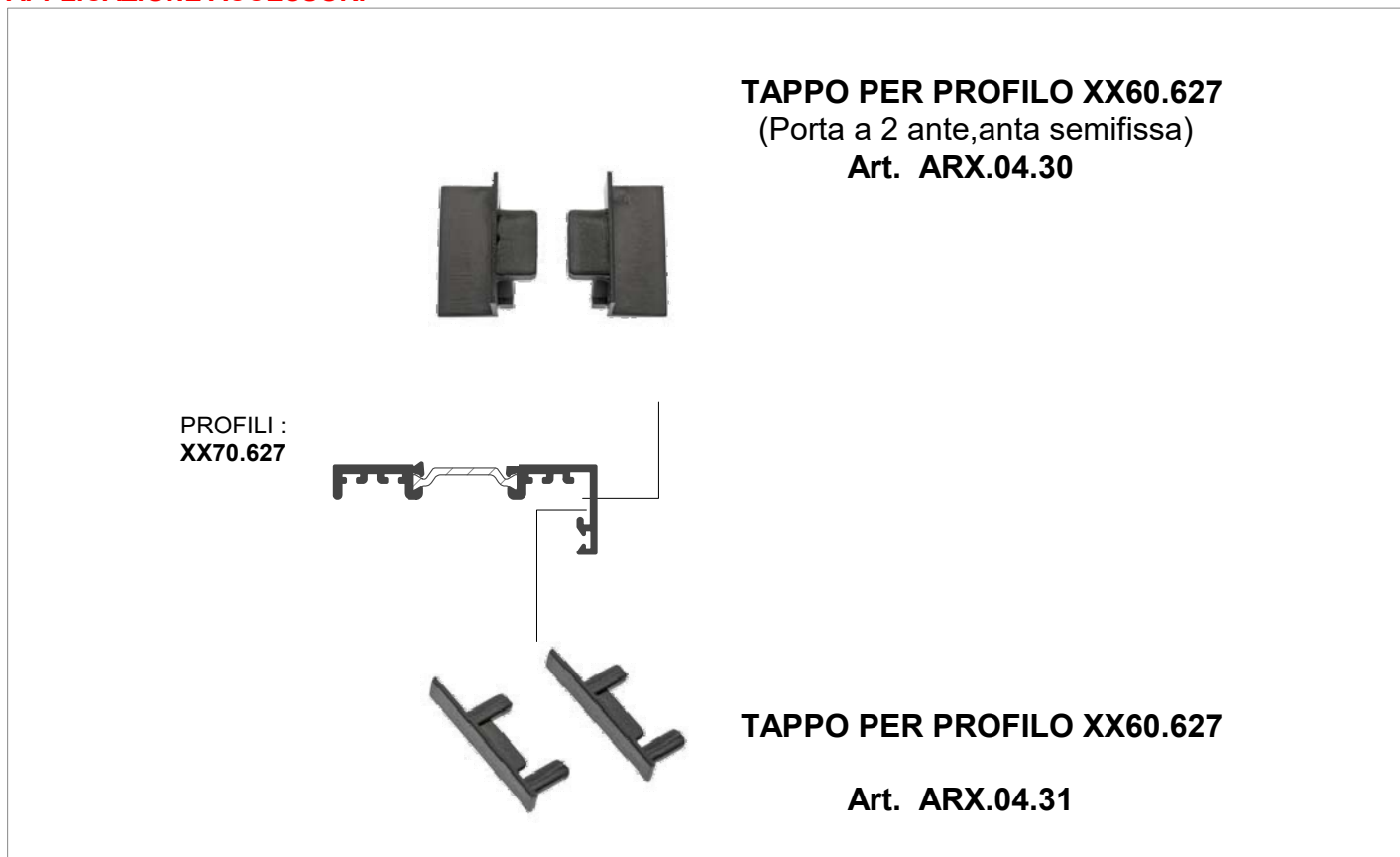

**TAPPO PER PROFILO XX60.627**  
(Porta a 2 ante, anta semifissa)  
**Art. ARX.04.30**

PROFILI :  
**XX70.627**

**TAPPO PER PROFILO XX60.627**  
**Art. ARX.04.31**



**APPLICAZIONE ACCESSORI**

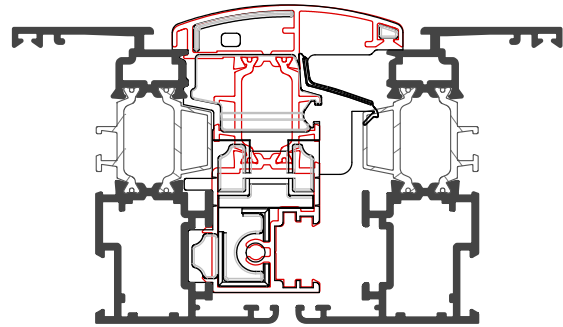
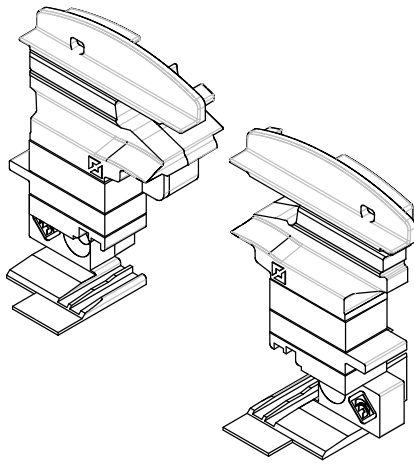

**ACX.04.01HP**  
Coppia tappi  
di riporto

**APPLICAZIONE ACCESSORI**

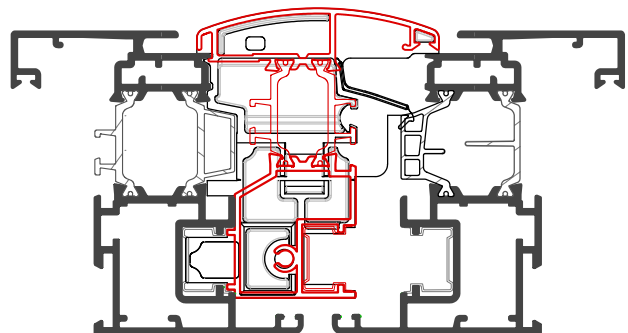
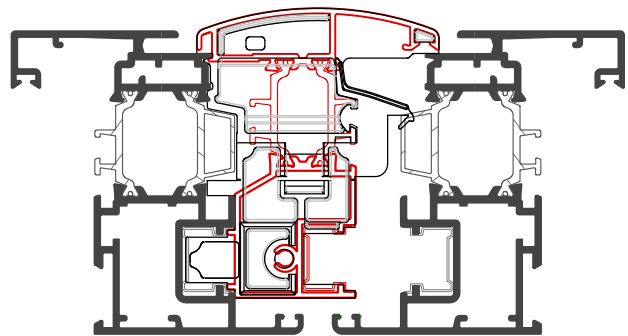
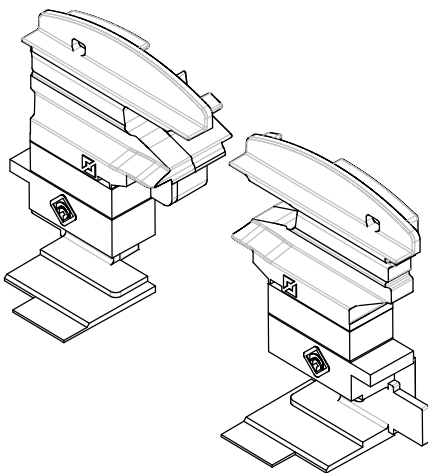

**ARX.04.02HP**  
Coppia tappi  
di riporto



**APPLICAZIONE ACCESSORI**

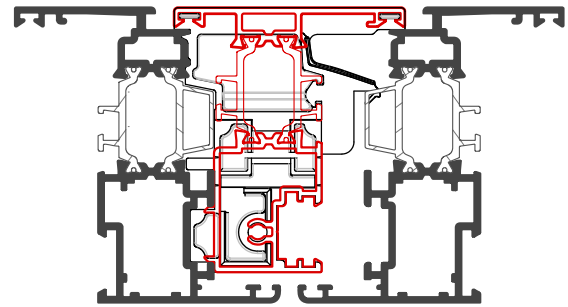
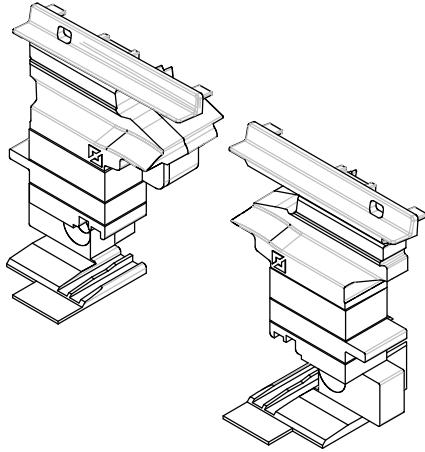

**ACX.04.03HP**  
Coppia tappi  
di riporto

**APPLICAZIONE ACCESSORI**

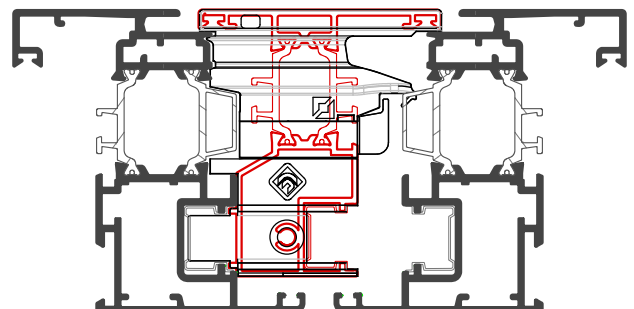
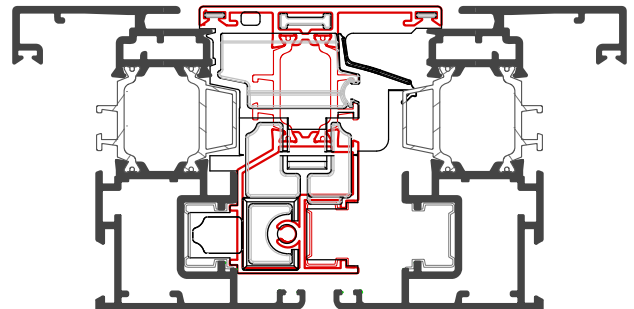
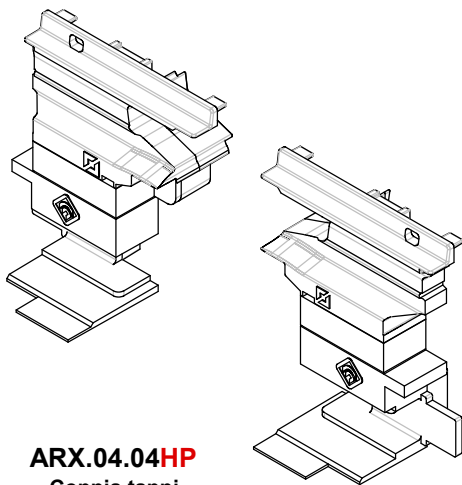

**ARX.04.04HP**  
Coppia tappi  
di riporto



**APPLICAZIONE ACCESSORI**

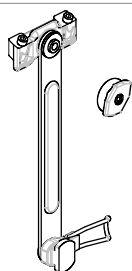

**ACX.02.08**  
Braccio limitatore  
altezza anta da 260mm a 800mm

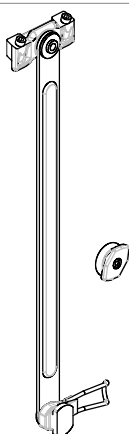

**ACX.02.07**  
Braccio limitatore  
altezza anta da 600mm a 1600mm

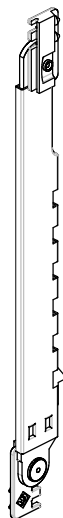

**ACX.02.09**  
Braccio telescopico a scatto

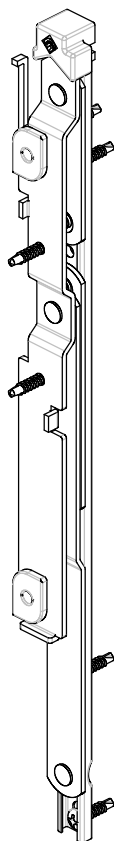
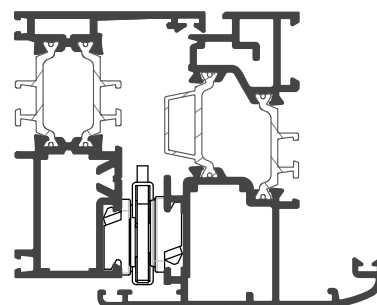
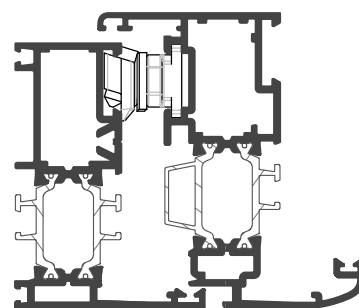

**ACX.02.10**  
Cerniera a compasso

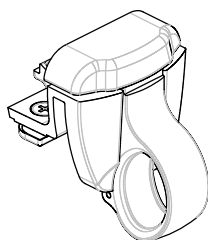
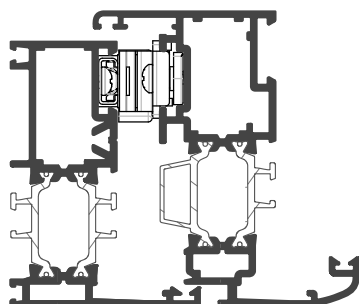

**ACX.03.01**  
Cricchetto ad aggancio con piastine  
per telai sormonto

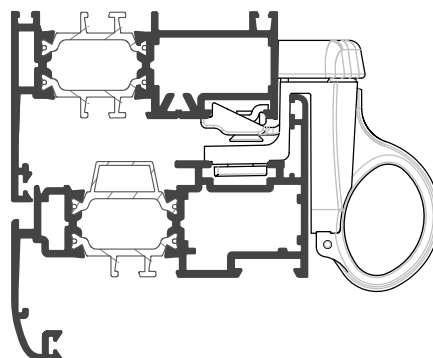



**APPLICAZIONE ACCESSORI**

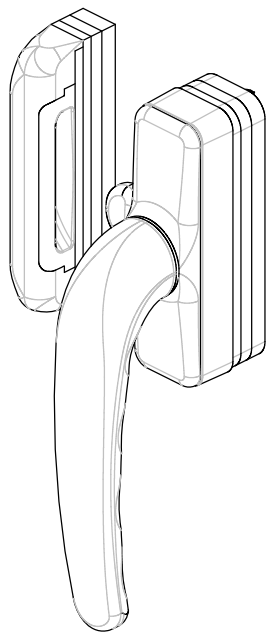

**ARX.03.02**  
Maniglia a tavellino

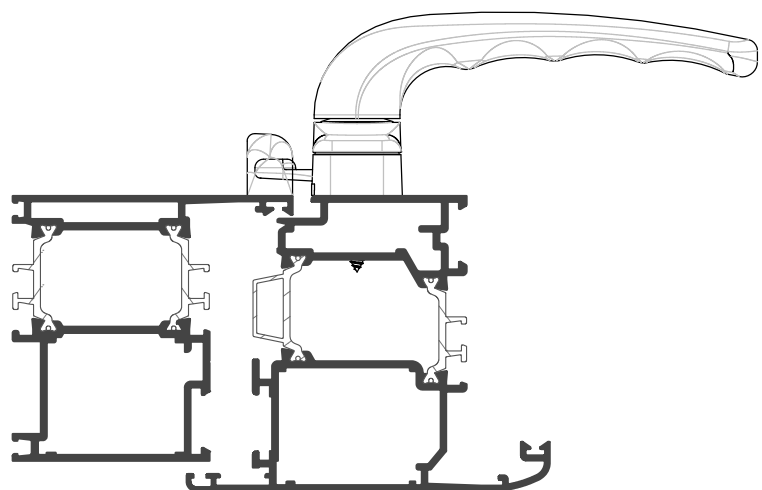
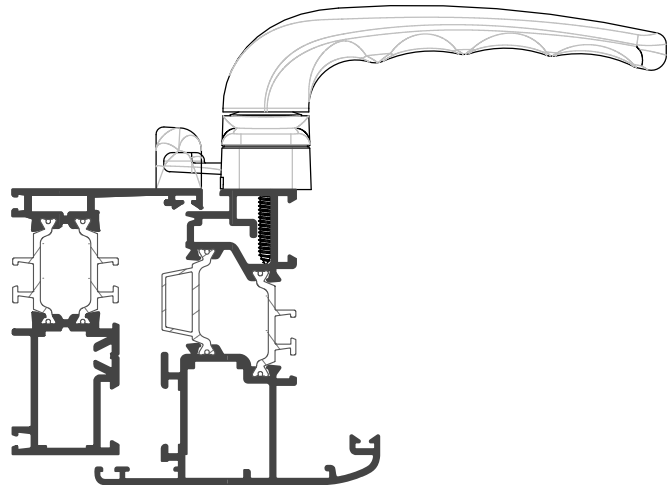



**APPLICAZIONE ACCESSORI**

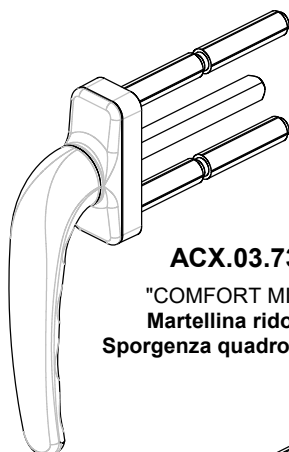

**ACX.03.73**  
"COMFORT MINI"  
Martellina ridotta  
Sporgenza quadro mm.70

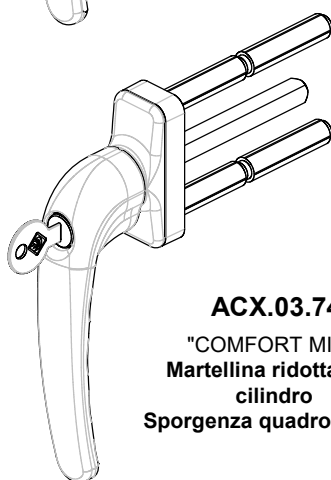

**ACX.03.74**  
"COMFORT MINI"  
Martellina ridotta con  
cilindro  
Sporgenza quadro mm.70



**ARX.03.67**  
Perno di trascinamento  
L = 27 mm.

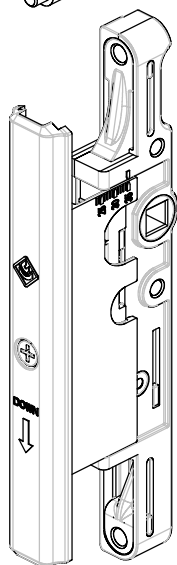

**ACX.03.72**  
Movimentazione Bidirezionale  
Interasse 23 - 35 mm.

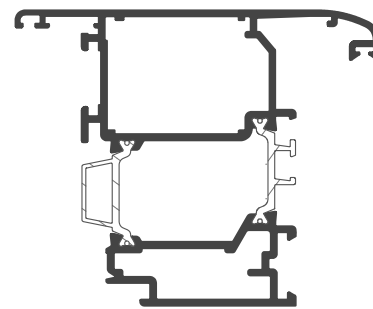
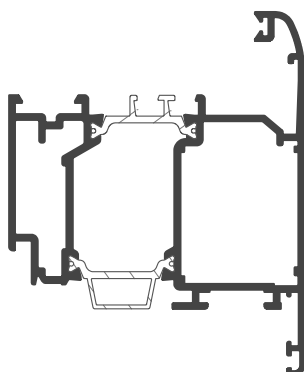
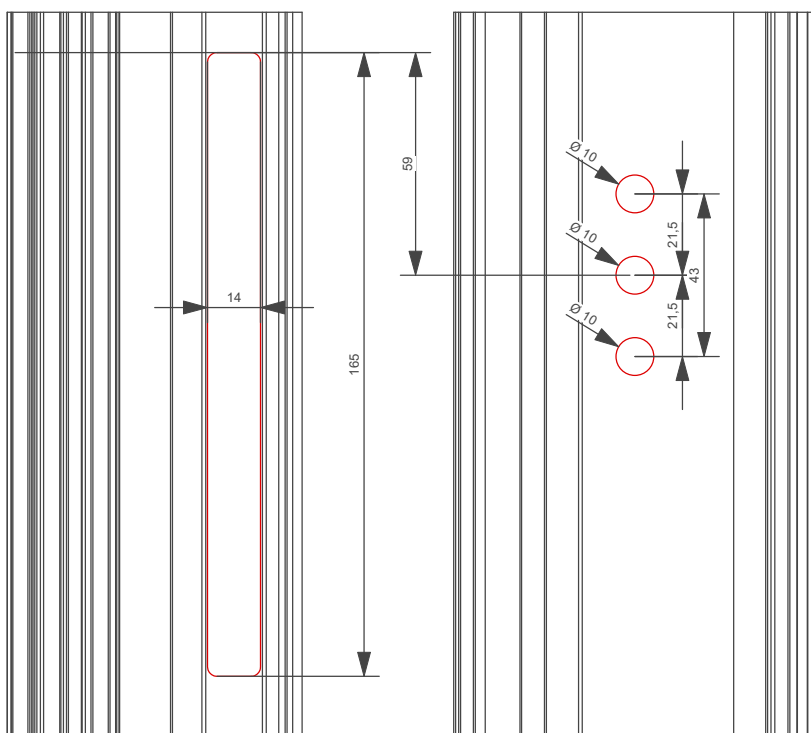
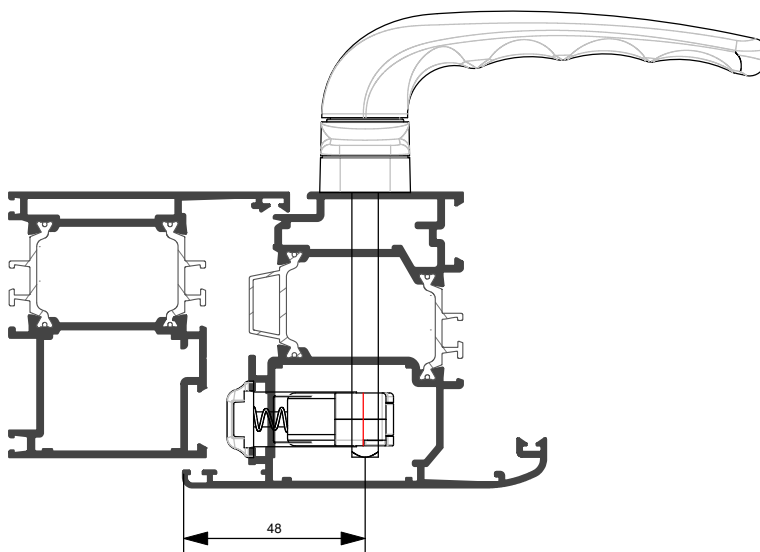



**APPLICAZIONE ACCESSORI**

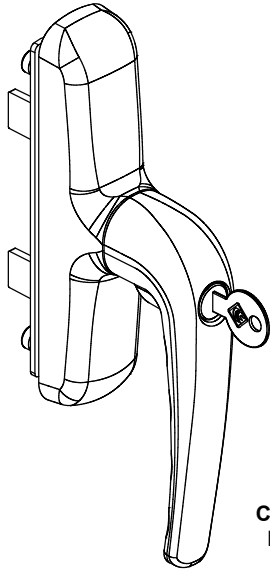

**ARX.03.07**

Cremonese con chiave  
Interasse 84 - 92 - 104

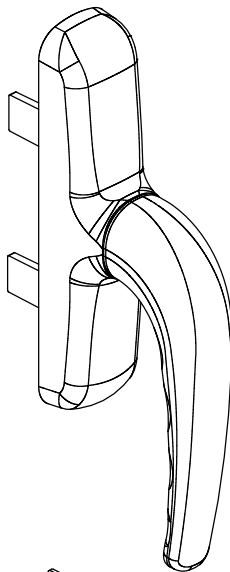
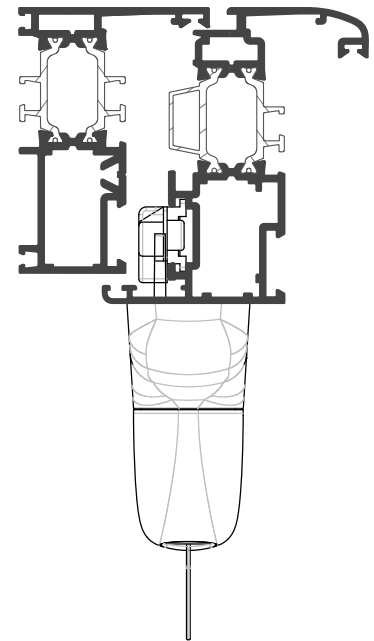
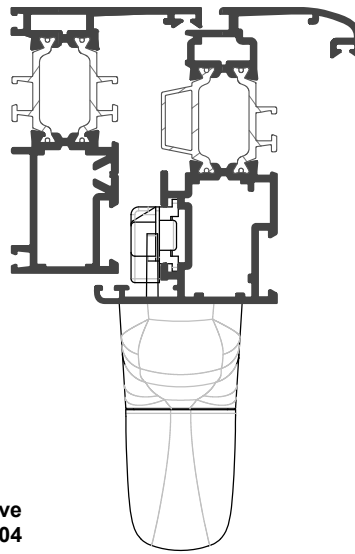

**ARX.03.06**

Cremonese  
Interasse 84 - 92 - 104

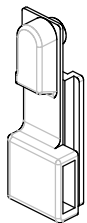
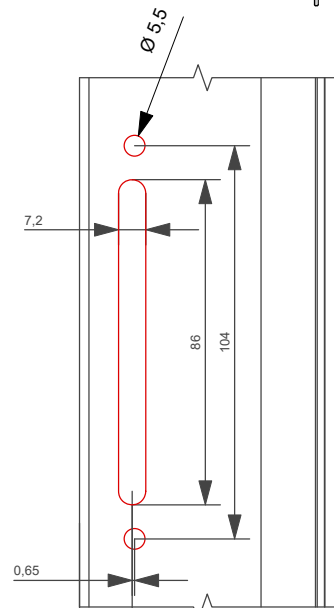

**ACX.03.17**

Innesti cremonese

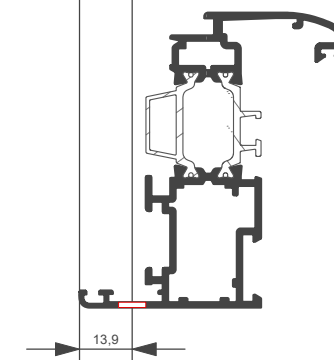



**APPLICAZIONE ACCESSORI**

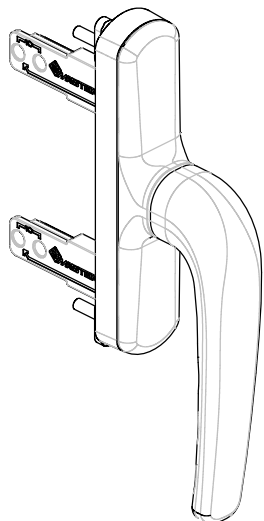

**ARX.03.47**

Cremonese apertura  
esterna - int. 28/65mm

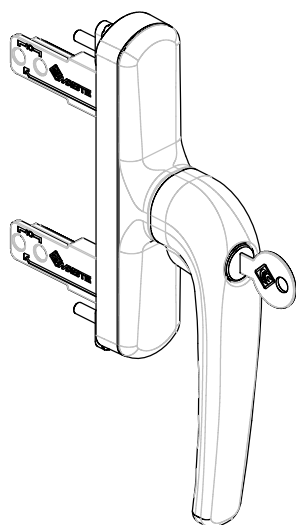
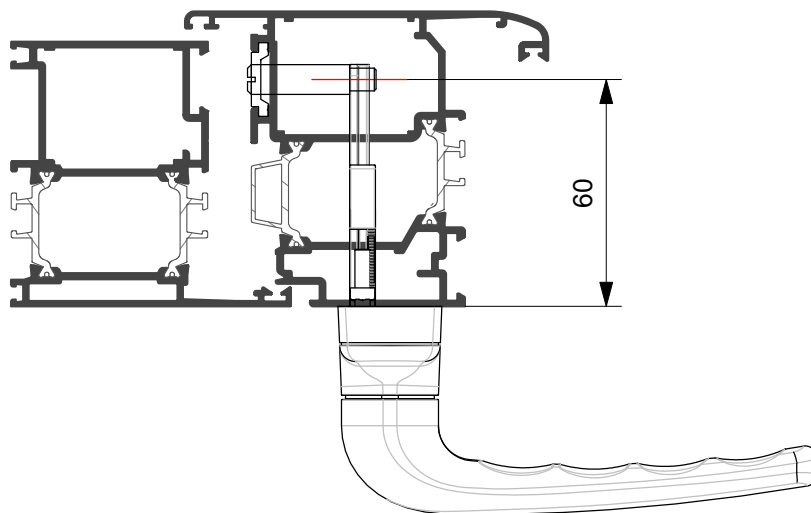

**ARX.03.48**

Cremonese apertura esterna  
con chiave - int. 38/65mm

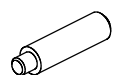
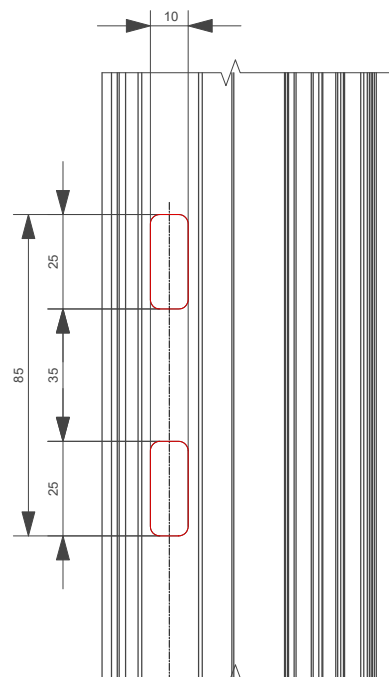
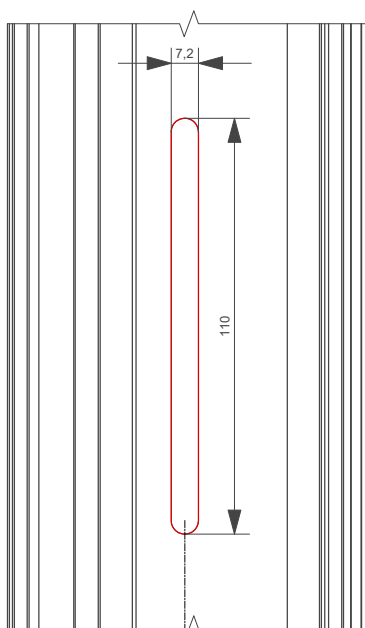

**ACX.03.67**

Perno di trascinamento  
L=27mm

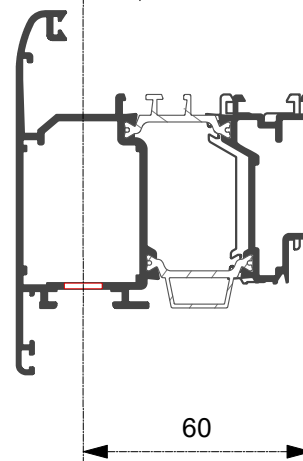
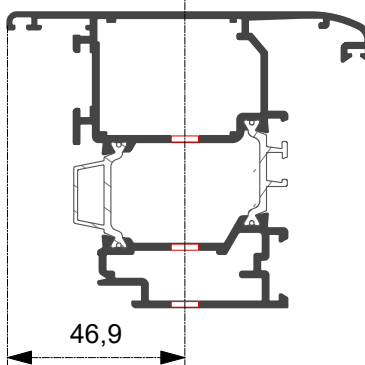





**APPLICAZIONE ACCESSORI**

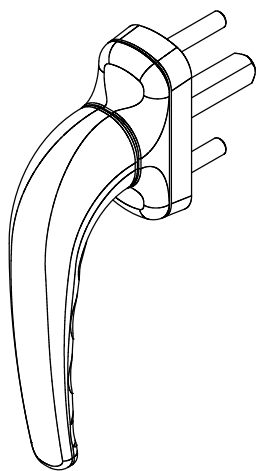

**ARX.03.04**

Martellina  
Sporgenza quadro mm.24

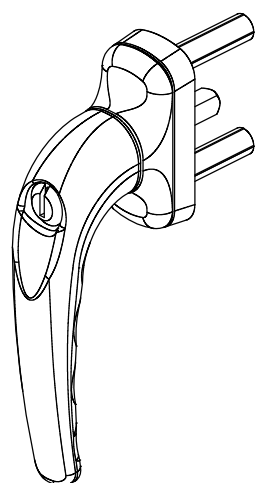

**ARX.03.05**

Martellina con chiave  
Sporgenza quadro mm.24

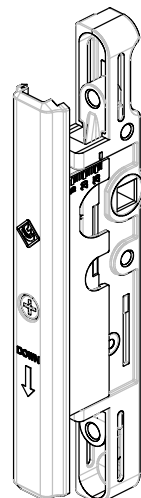

**ARX.03.09**

Movimentazione bidirezionale  
regolabile 15 - 27 mm.



**ACX.03.66**  
Perno 11 mm.

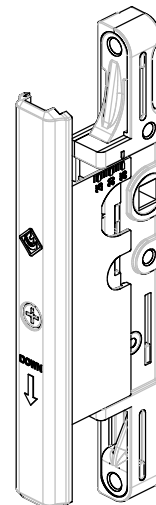

**ACX.03.72**

Movimentazione bidirezionale  
regolabile 23 - 35 mm.

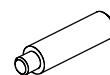

**ACX.03.67**  
Perno 27 mm.

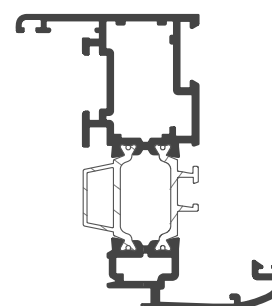
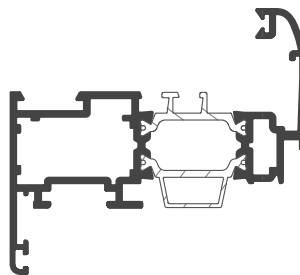
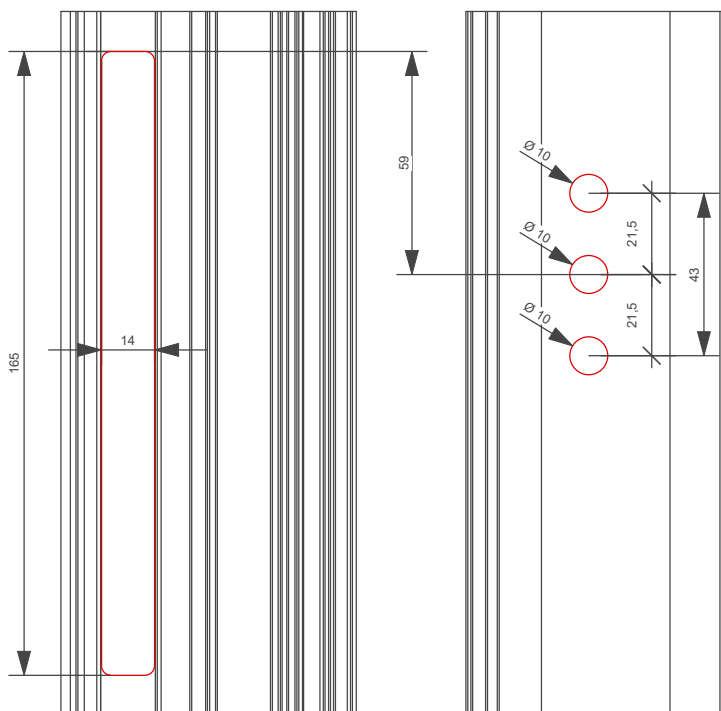
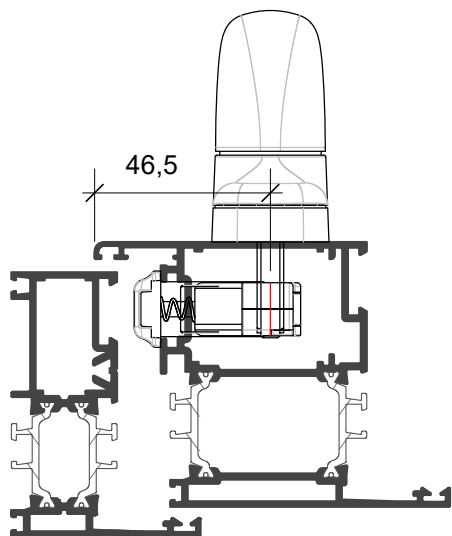
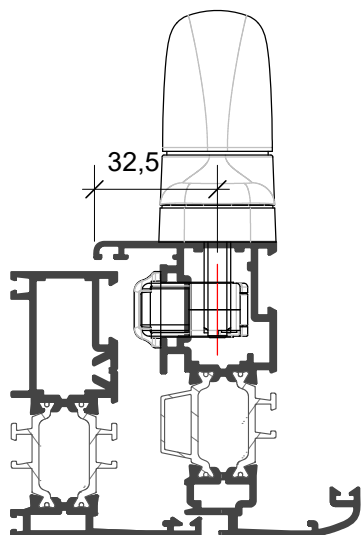



**APPLICAZIONE ACCESSORI**

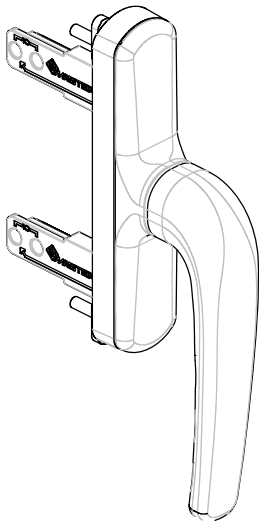

**ARX.03.47**

Cremonese apertura  
esterna - int. 28/65mm

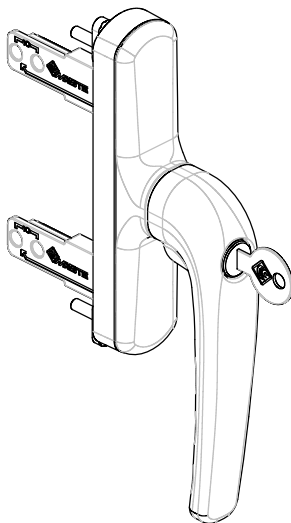
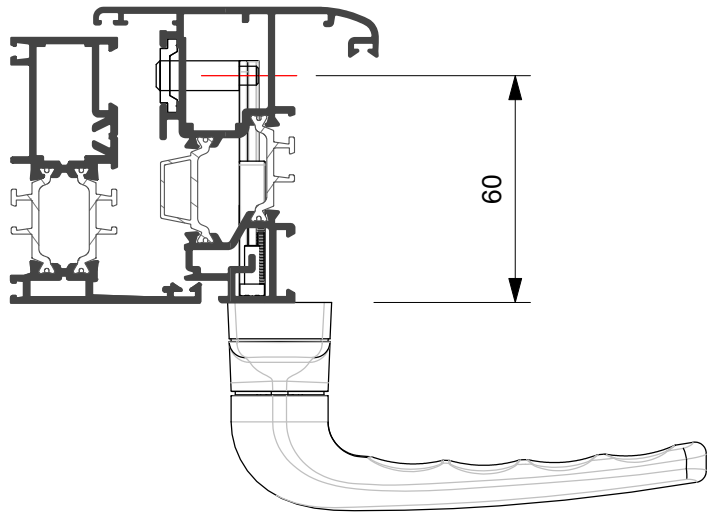

**ARX.03.48**

Cremonese apertura esterna  
con chiave - int. 38/65mm

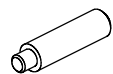
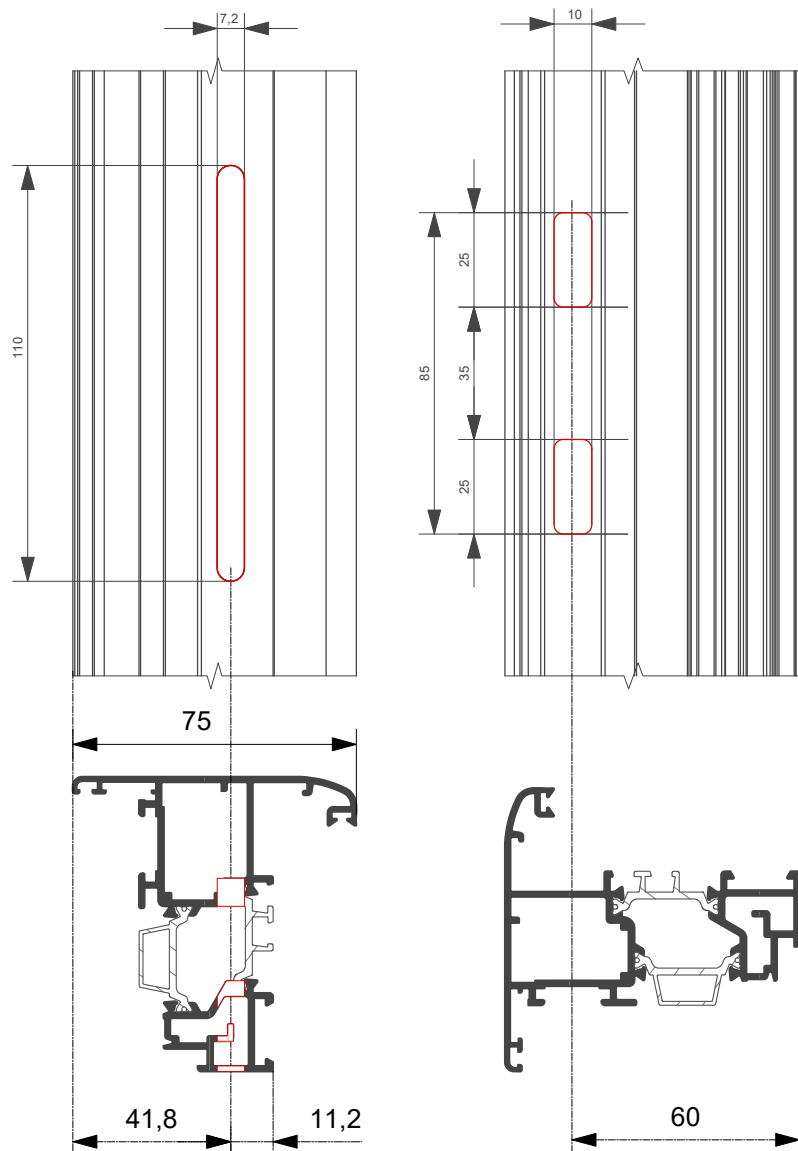

**ARX.03.45**

Perno di trascinamento  
L=22mm



**APPLICAZIONE ACCESSORI**

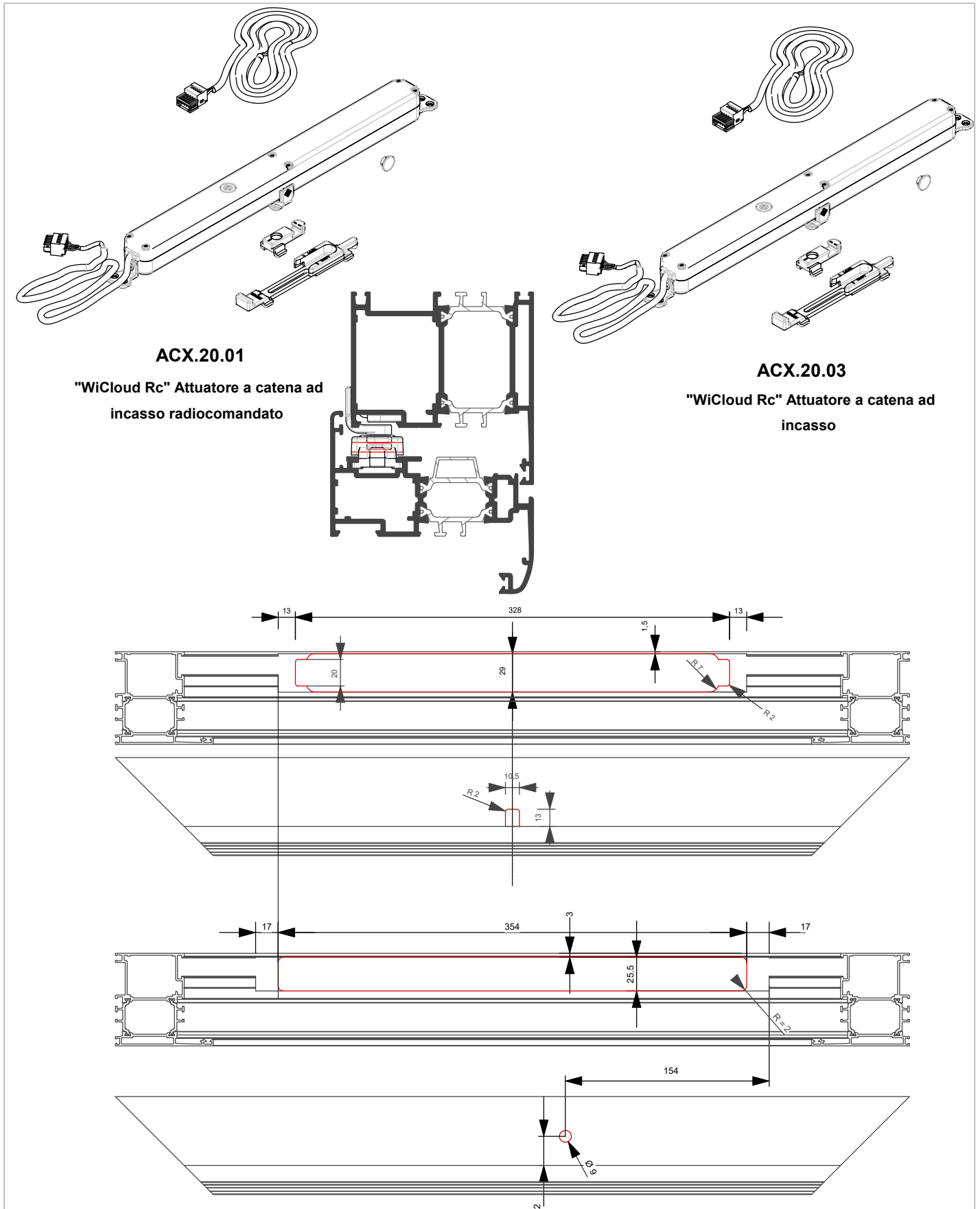

**NB.** Maggiori idettagli di montaggio nella confezione



**APPLICAZIONE ACCESSORI**

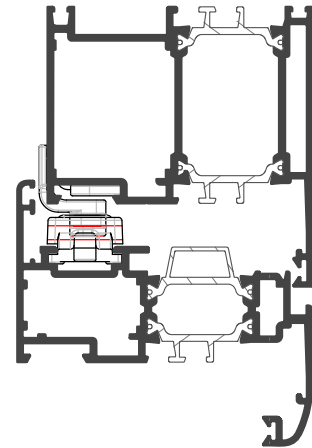
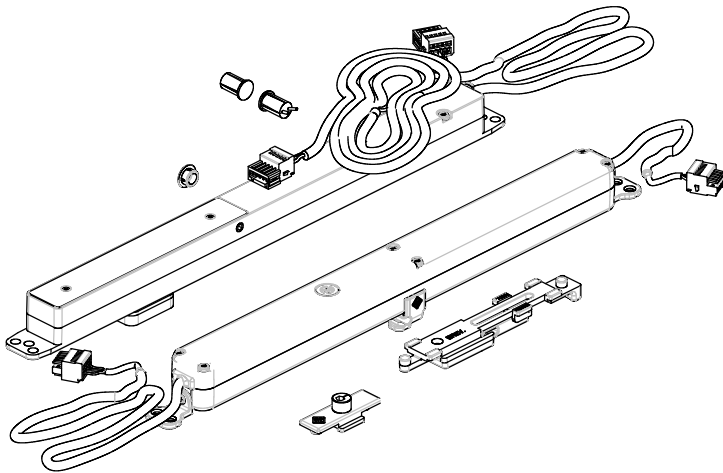

**ACX.20.04**

"WiCloud Rc - Lock"

Attuatore a catena radiocomandato + serratura elettromeccanica

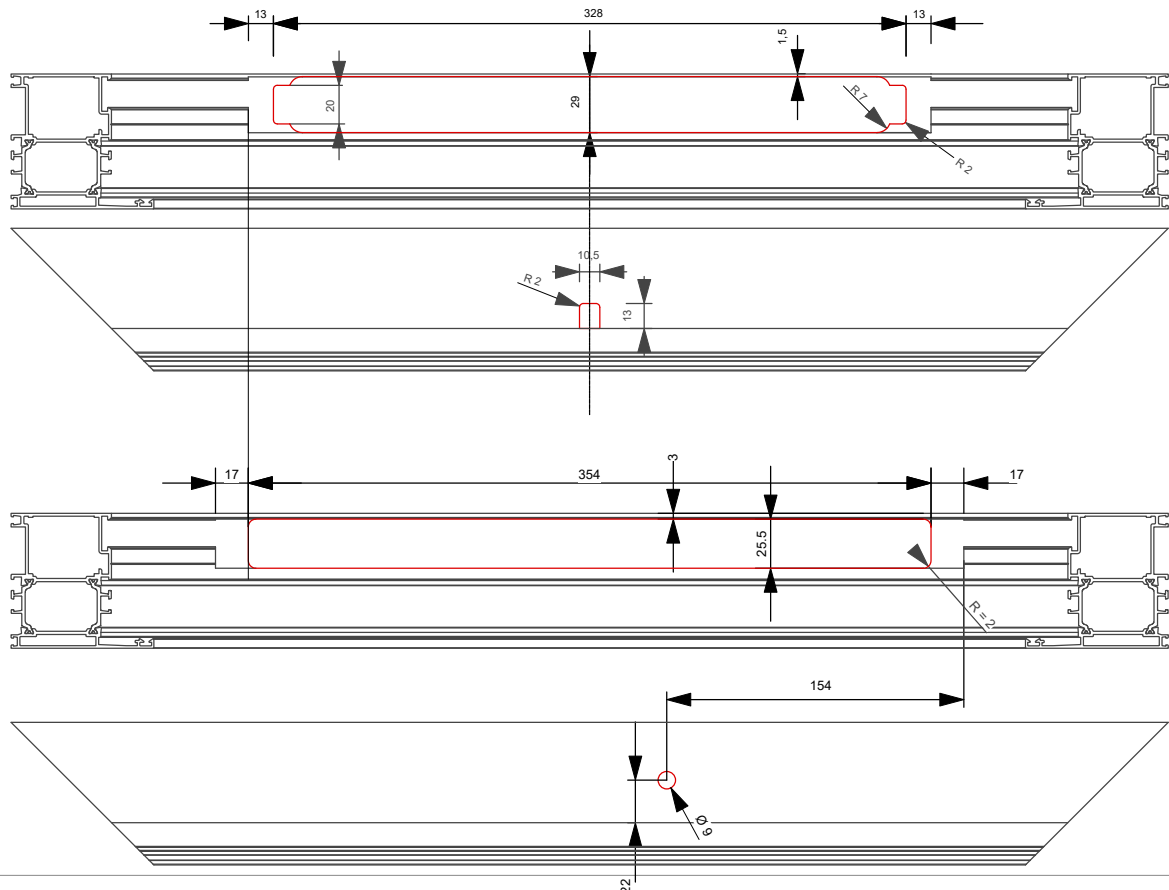

**NB.** Maggiori idettagli di montaggio nella confezione



**GRUPPO FRESA**  
Art. ACX.09.02

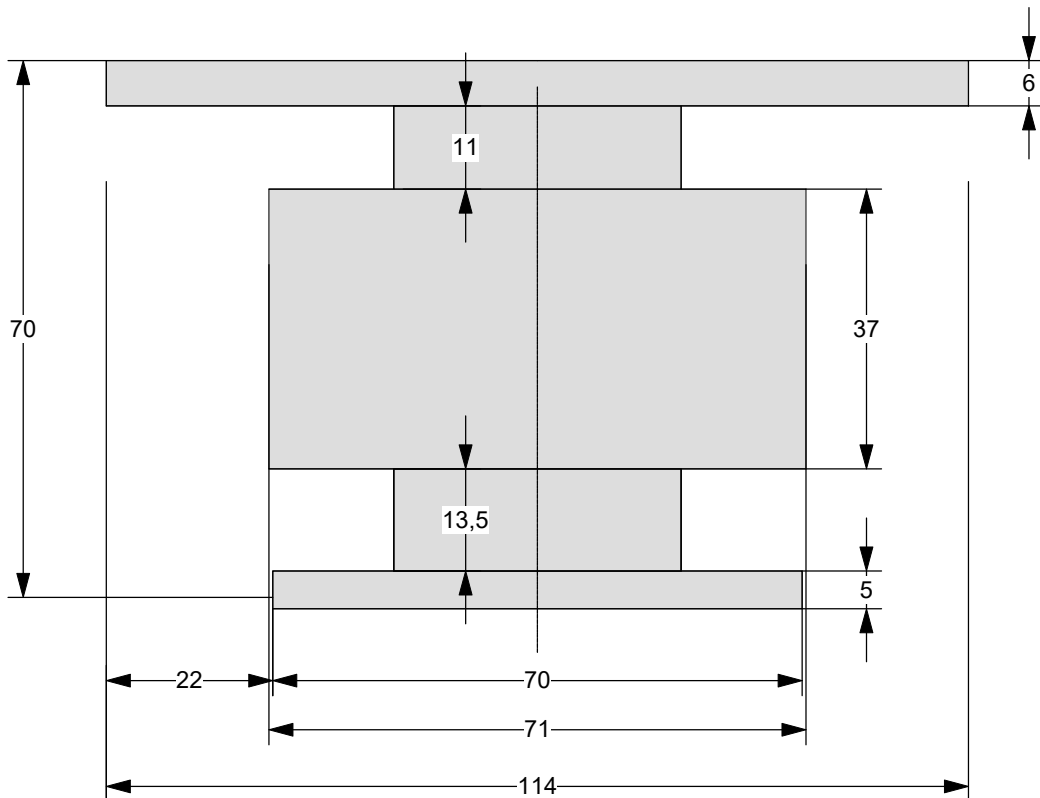
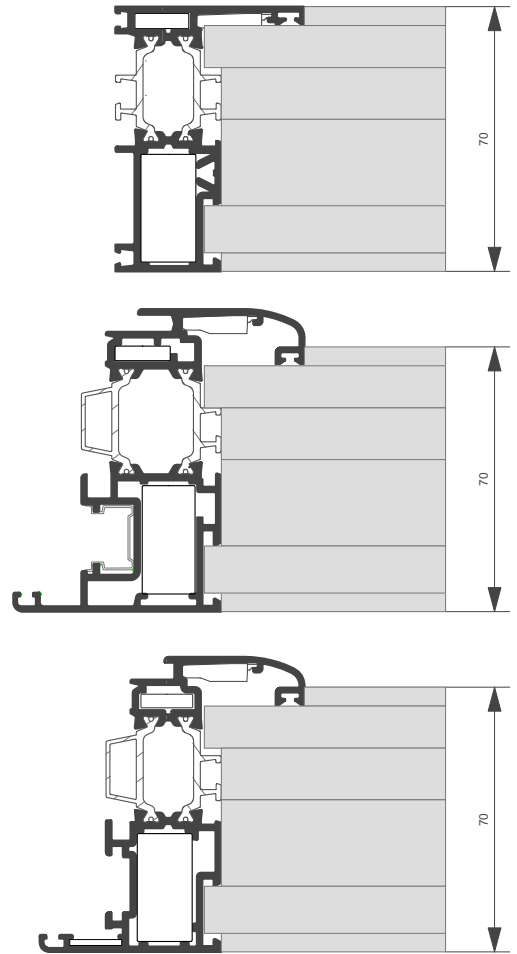



**APPLICAZIONE ACCESSORI**

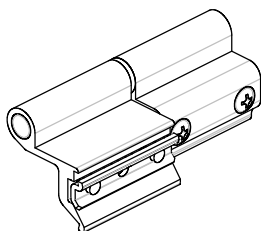

**ACX.02.01**

Cerniera a montaggio rapido a 2 ali

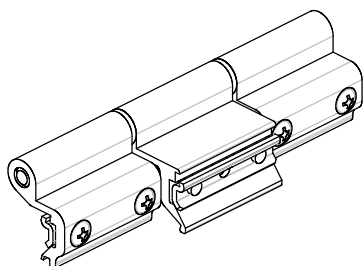

**ACX.02.03**

Cerniera a montaggio rapido a 3 ali

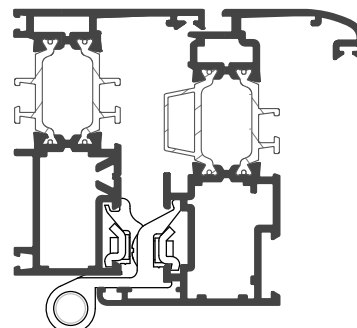

**APPLICAZIONE ACCESSORI**

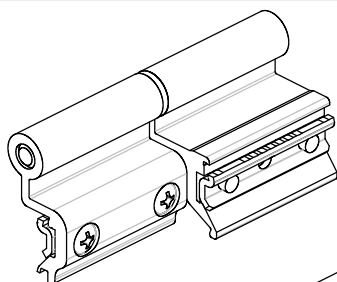

**ACX.02.02**

Cerniera a montaggio rapido a 2 ali

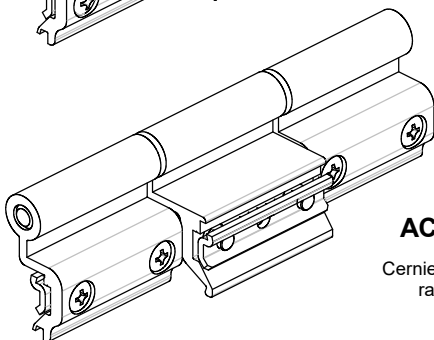

**ACX.02.04**

Cerniera a montaggio rapido a 3 ali

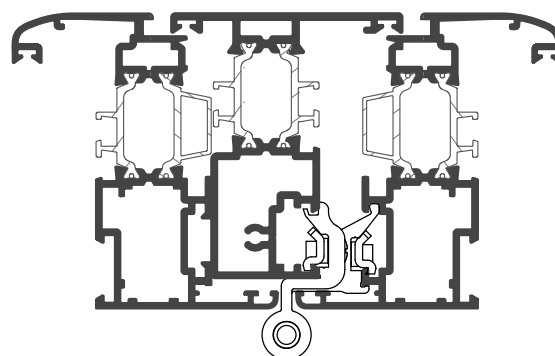

**APPLICAZIONE ACCESSORI**

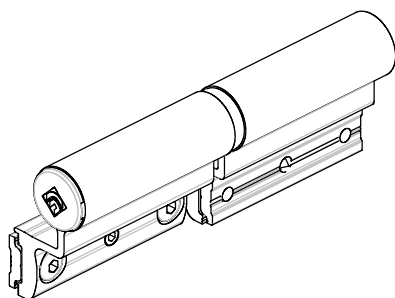

**ACX.02.11**

Cerniera porte a 2 ali

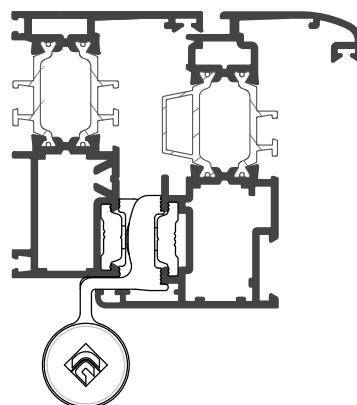



**APPLICAZIONE ACCESSORI**

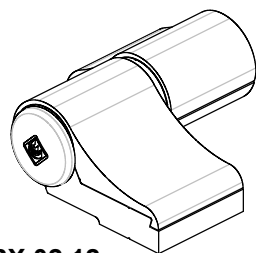
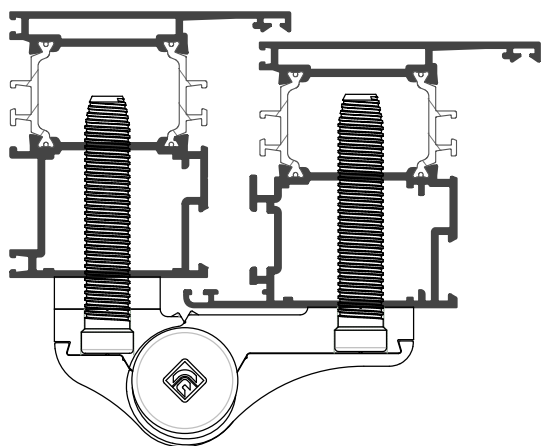

**ARX.02.12**

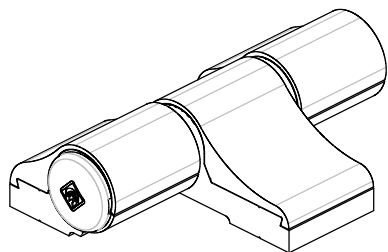

**ARX.02.13**

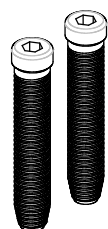

**ARX.02.23**

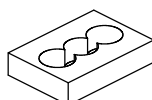

**ARX.02.25**

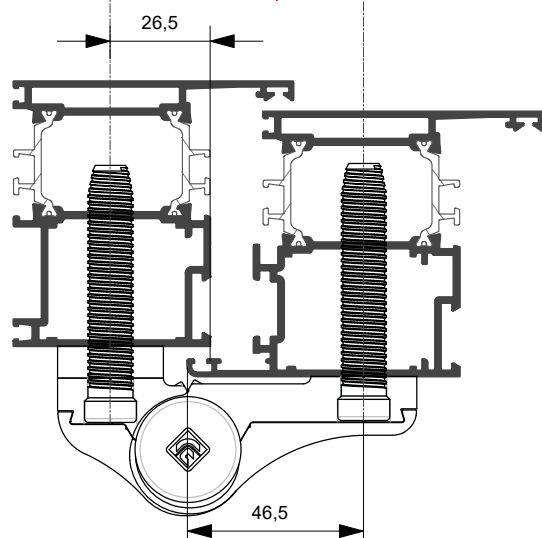
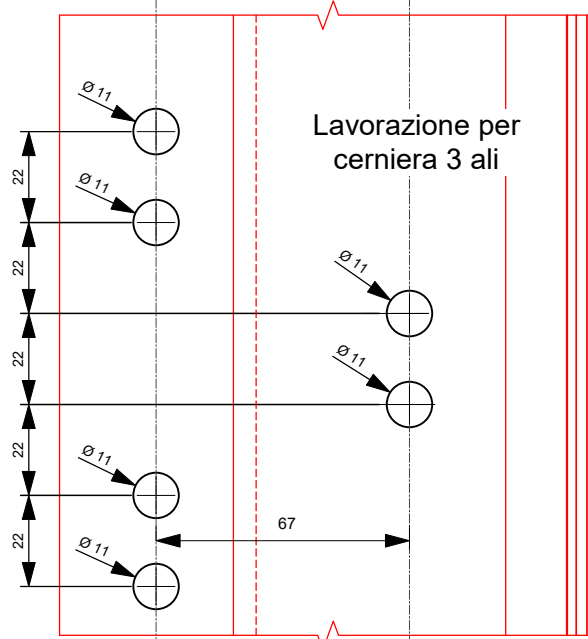
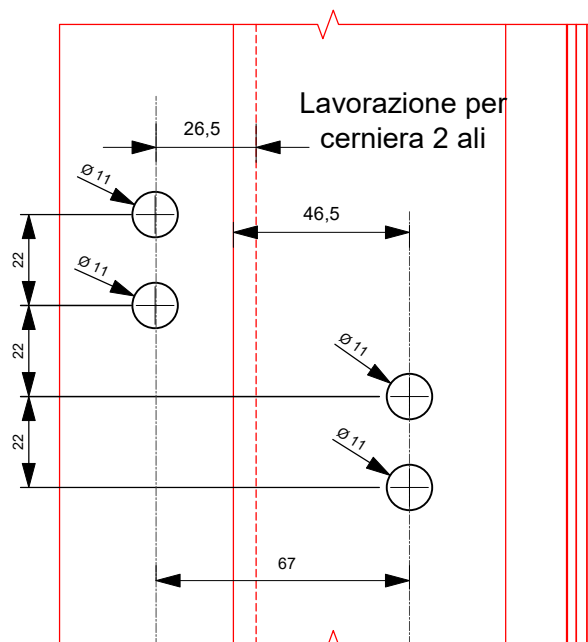



**APPLICAZIONE ACCESSORI**

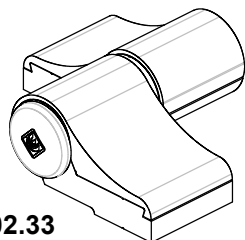
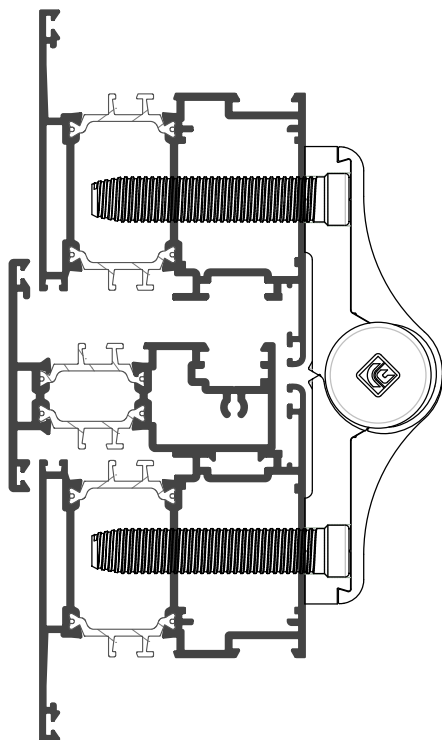

**ARX.02.33**

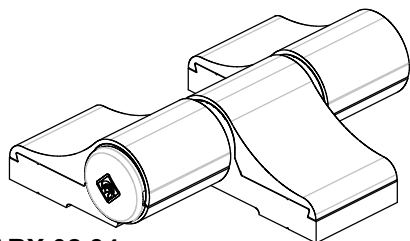

**ARX.02.34**

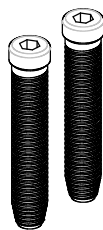

**ARX.02.23**

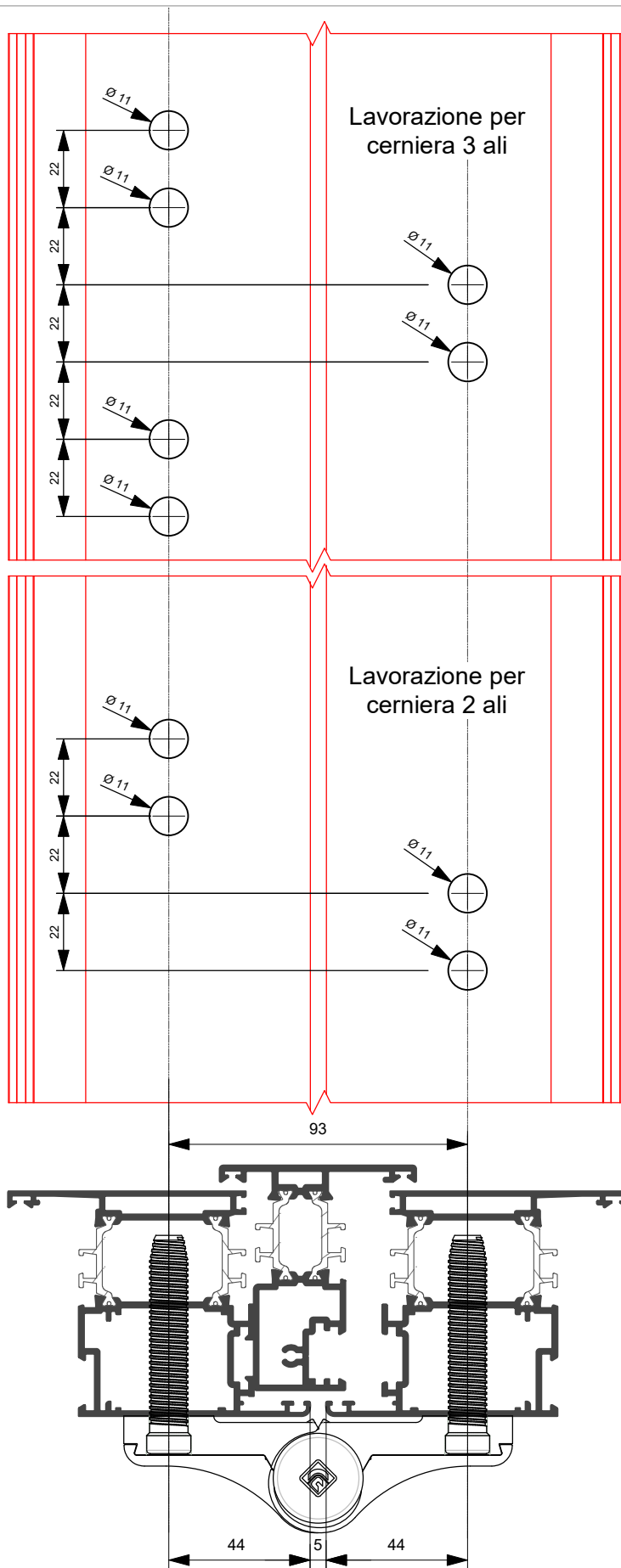





**APPLICAZIONE ACCESSORI**

**ACX.08.39**

WEEN HIDE 180- Sx/Dx Cerniera inferiore

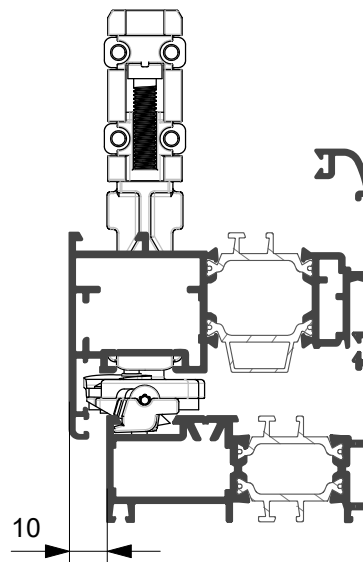
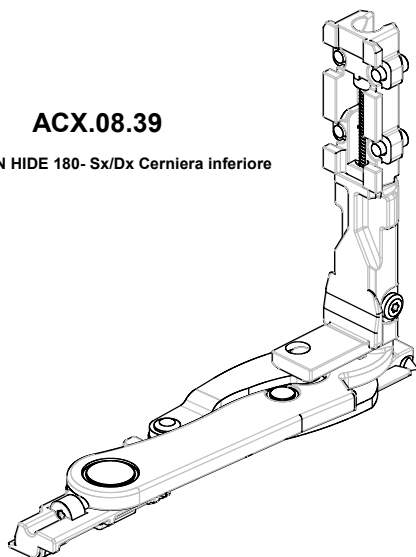

**NB**

Solo per anta **CX70.260** e **CX70.261**

**APPLICAZIONE ACCESSORI**

**ACX.08.36**

WEEN HIDE 180- Dx Braccio a scomparsa per apertura a battente

**ACX.08.37**

WEEN HIDE 180- Sx Braccio a scomparsa per apertura a battente

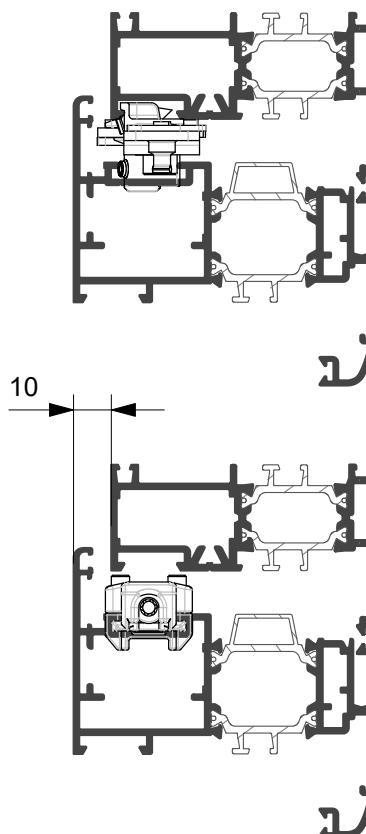
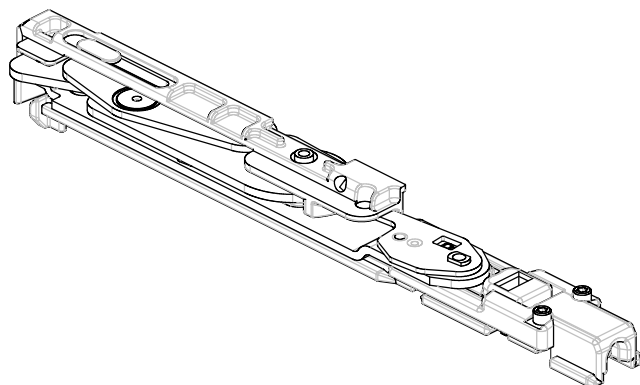

**NB**

Solo per anta **CX70.260** e **CX70.261**



**APPLICAZIONE ACCESSORI**

**RIBALTA**

**ACX.08.40**

Ween hide 180

kit base anta ribalta con anti falsa manovra sulla  
cremonese ante CX70.260 e CX70.261

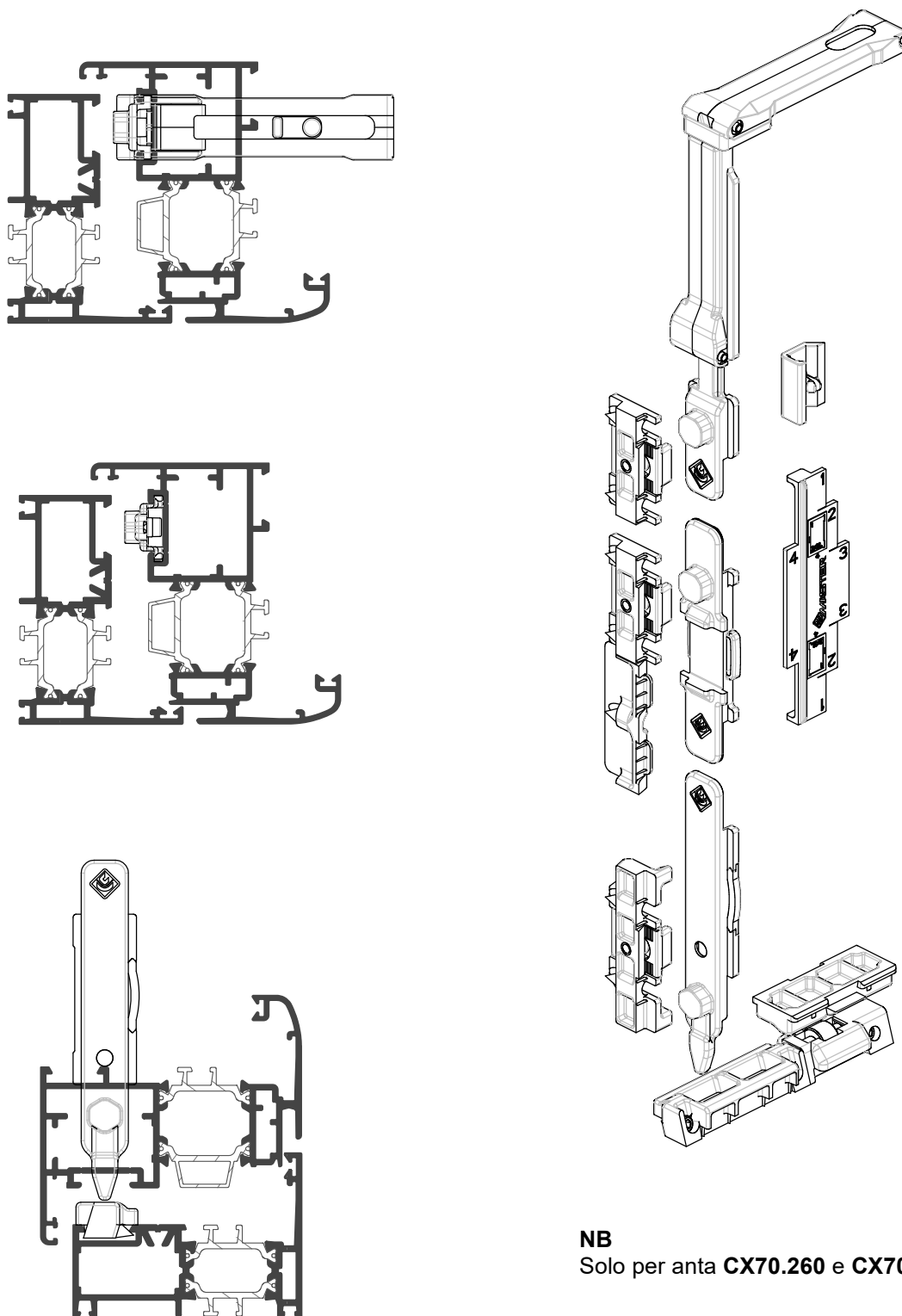

**NB**

Solo per anta **CX70.260** e **CX70.261**



**APPLICAZIONE ACCESSORI**

**RIBALTA**

**ACX.08.41**

Ween hide 180

kit base anta ribalta con anti falsa manovra sulla cremone  
ante CX70.260 e CX70.261

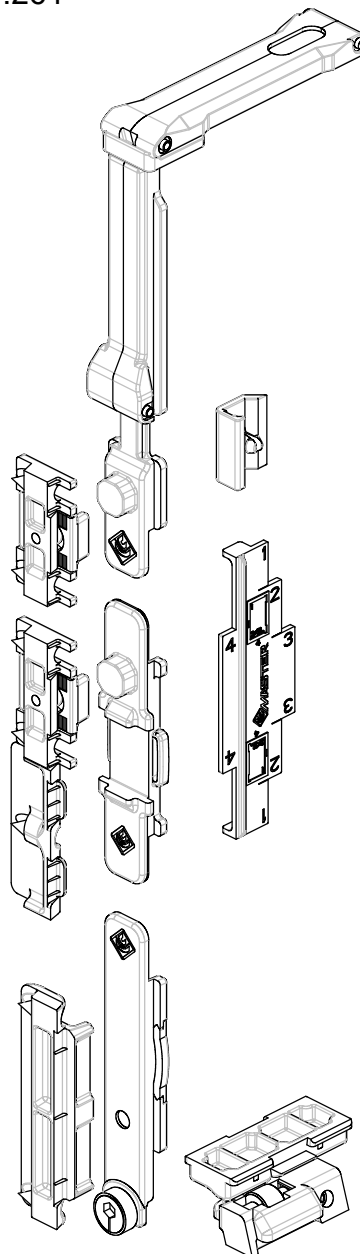
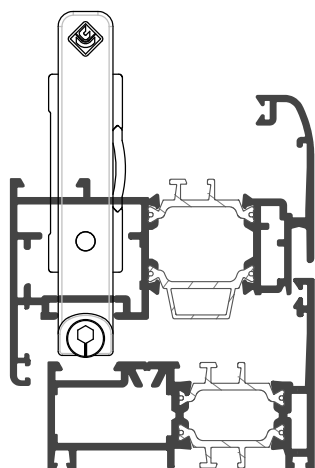
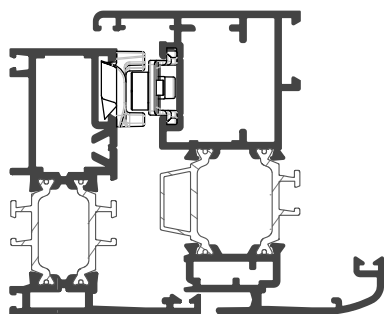
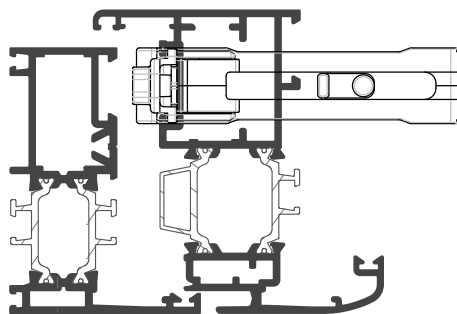

**NB**

Solo per anta **CX70.260** e **CX70.261**



**APPLICAZIONE ACCESSORI**

**RIBALTA**

**ACX.08.01**

Kit base anta ribalta  
Portata massima 160Kg

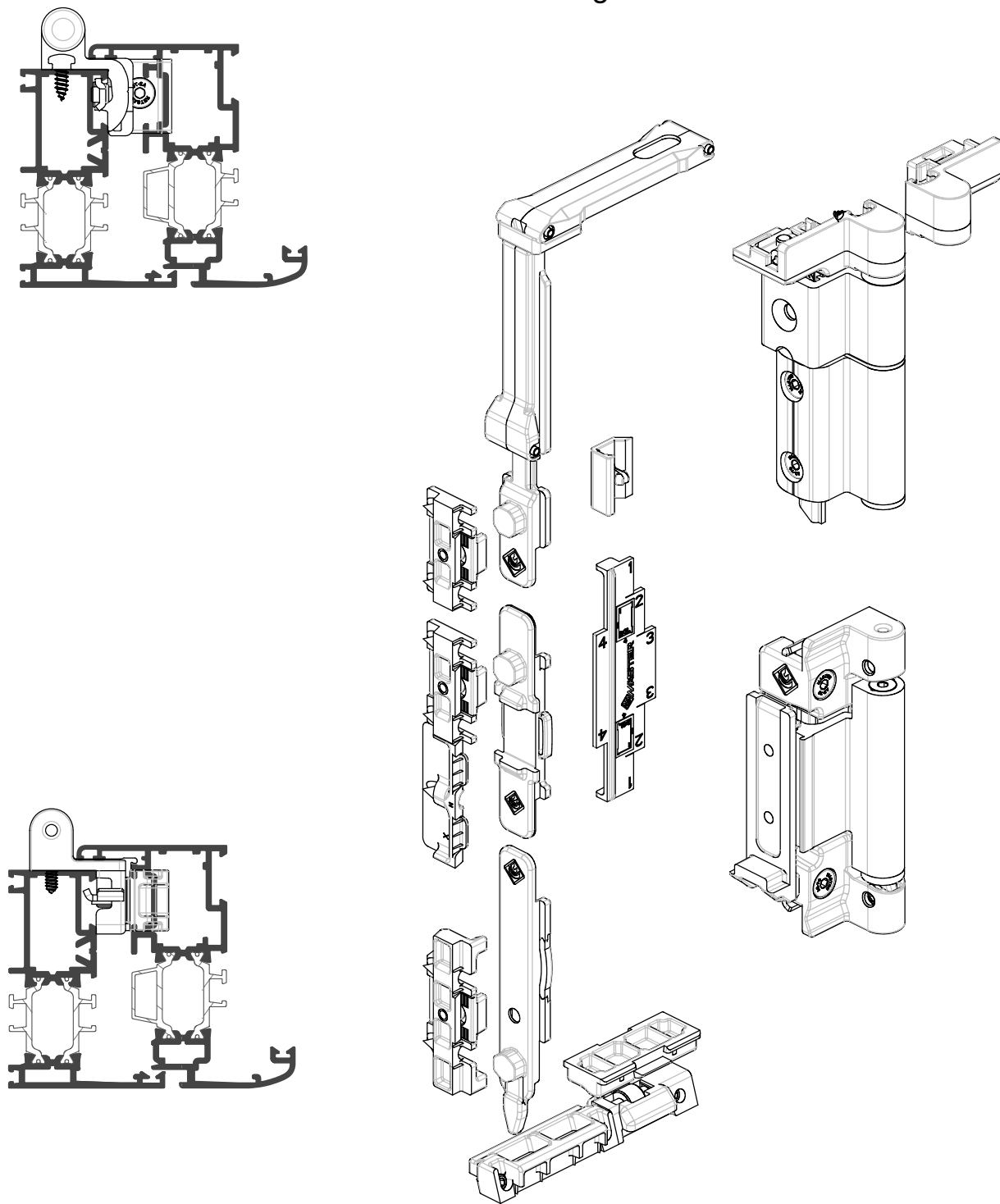



**APPLICAZIONE ACCESSORI**

**RIBALTA**

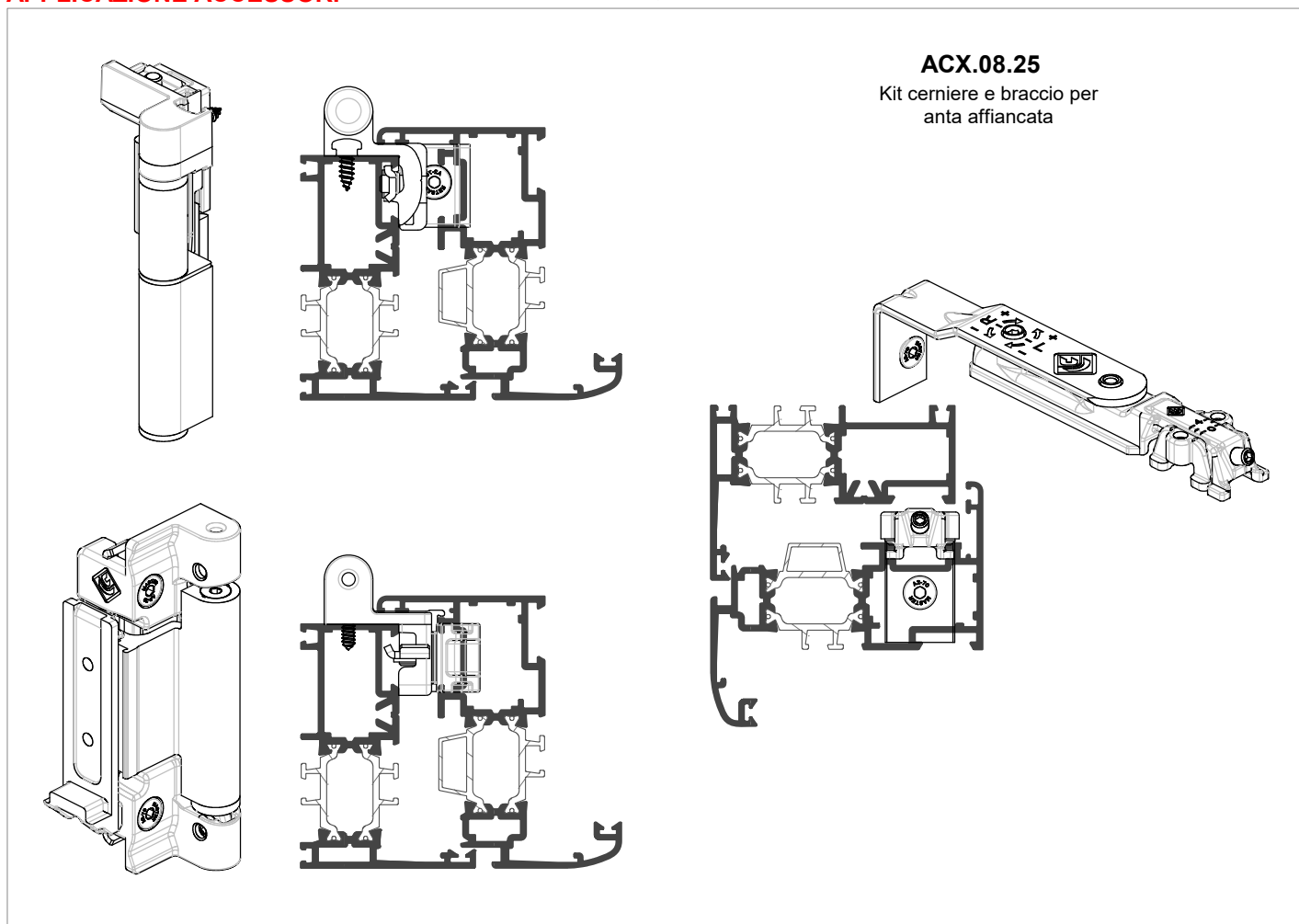

**APPLICAZIONE ACCESSORI**

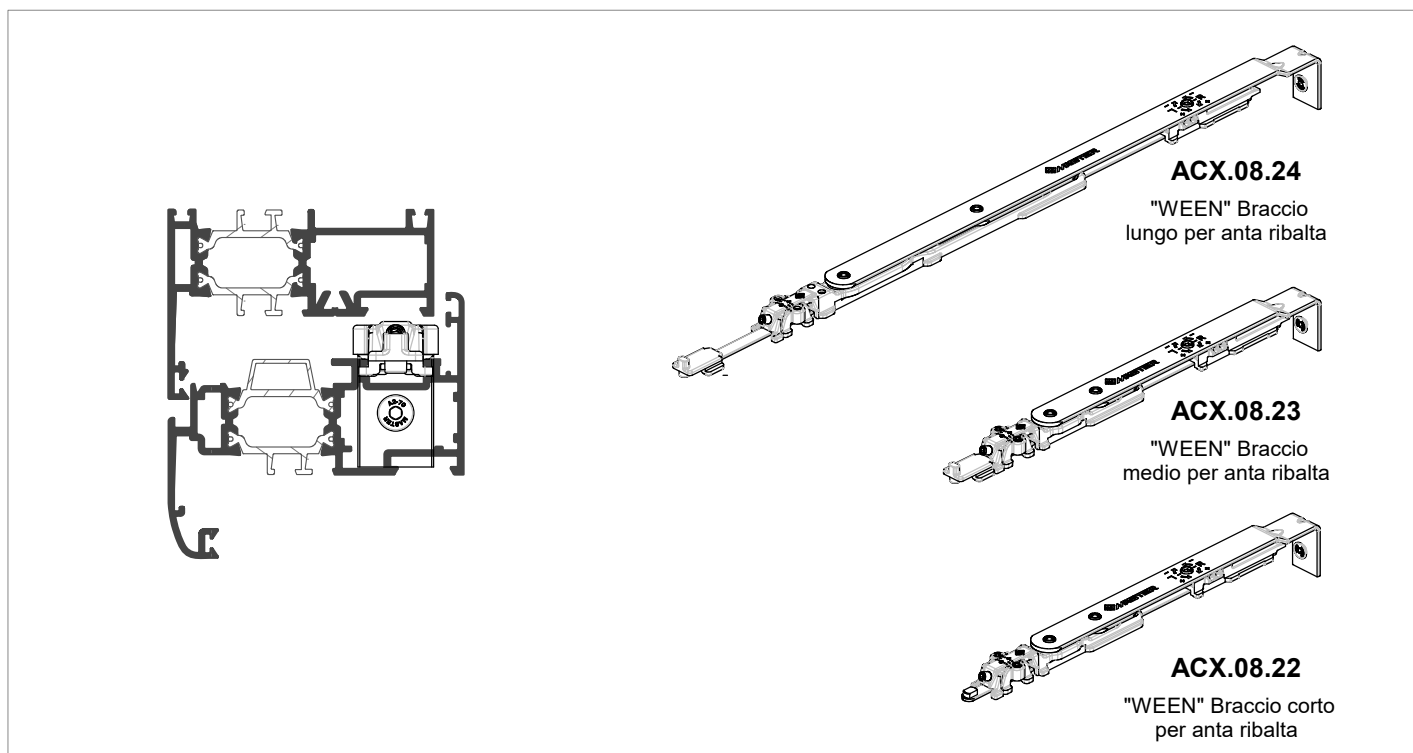



**APPLICAZIONE ACCESSORI**

**RIBALTA**

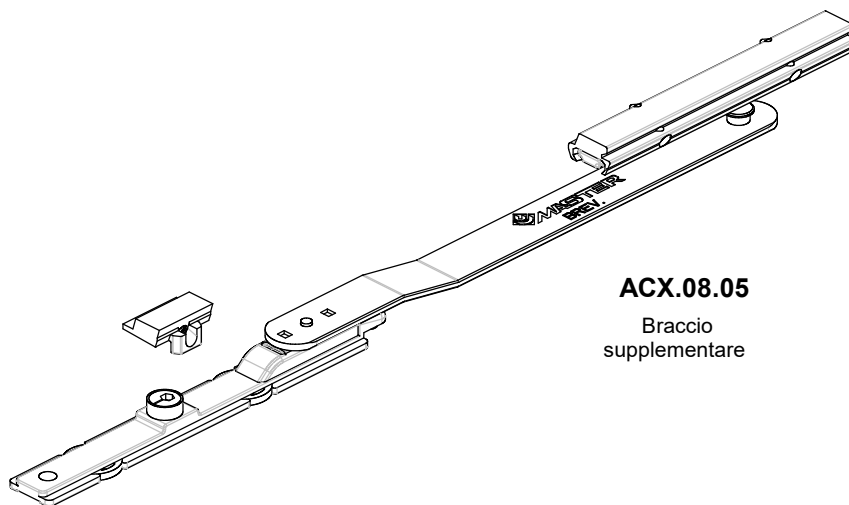
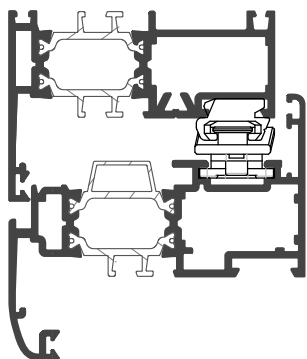

**ACX.08.05**  
Braccio  
supplementare

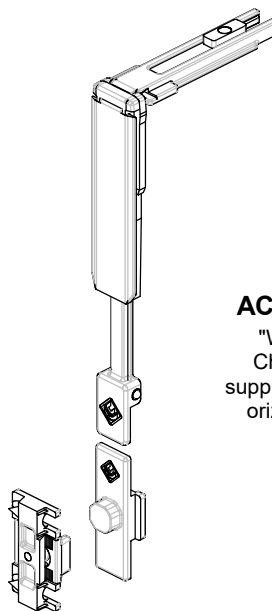
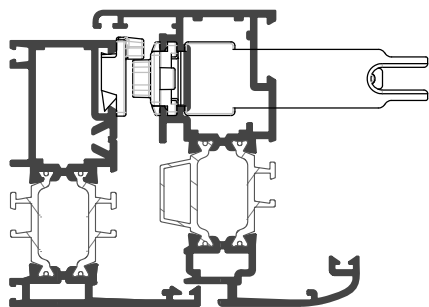

**ACX.08.06**  
"WEEN"  
Chiusura  
supplementare  
orizz./vert.

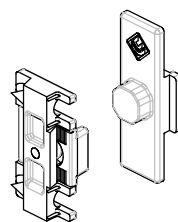
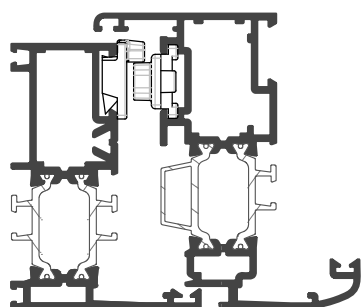

**ACX.08.16**  
"WEEN"  
Punto chiusura  
supplementare



**APPLICAZIONE ACCESSORI**

**RIBALTA**

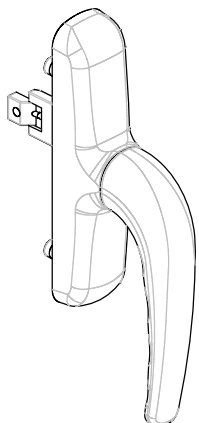

**ARX.03.08**  
Cremonese per anta ribalta

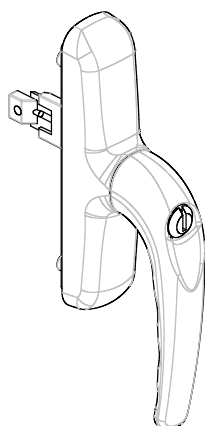
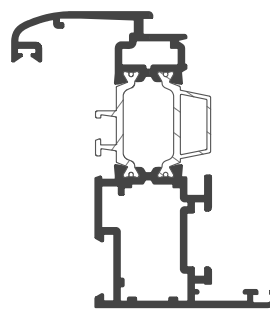
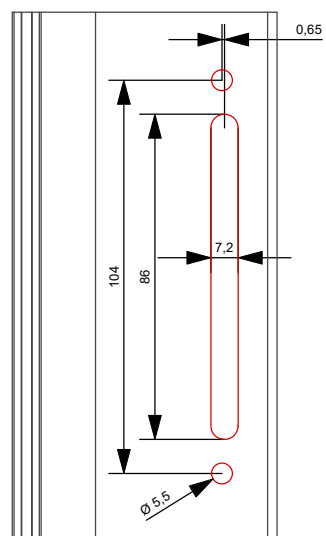
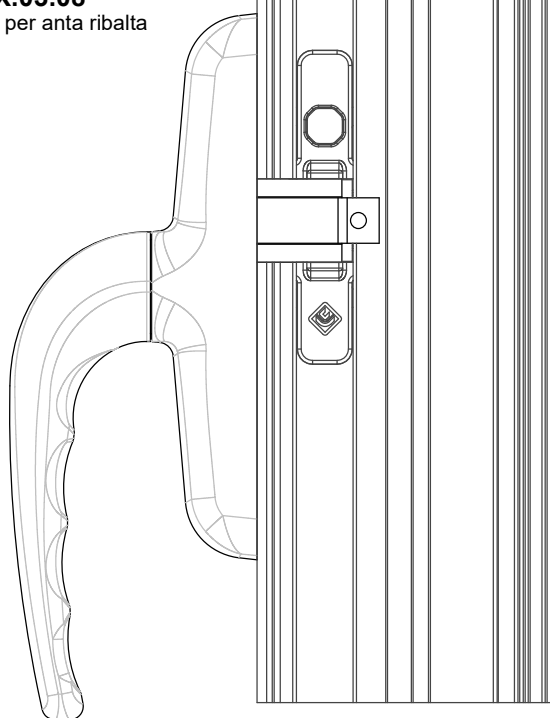

**ARX.03.46**  
Cremonese con chiave per anta ribalta

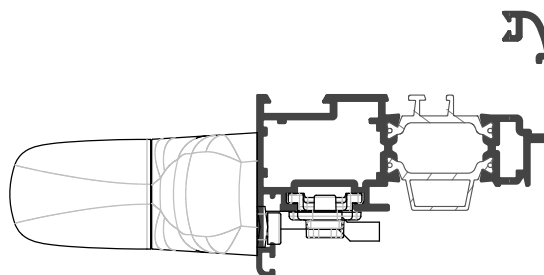



**APPLICAZIONE ACCESSORI**

**SLIM**

**ACX.03.70**

catenaccio a comando diretto SIRIO

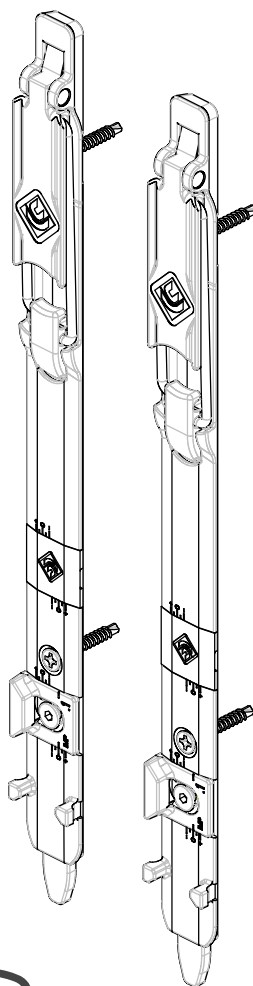
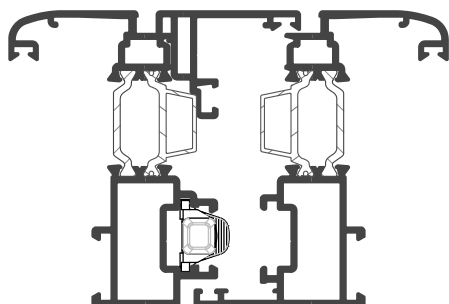
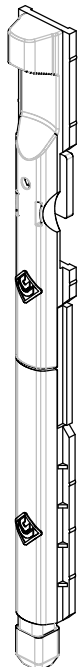

**ACX.08.44**

Kit catenacci a leva per anta affiancata

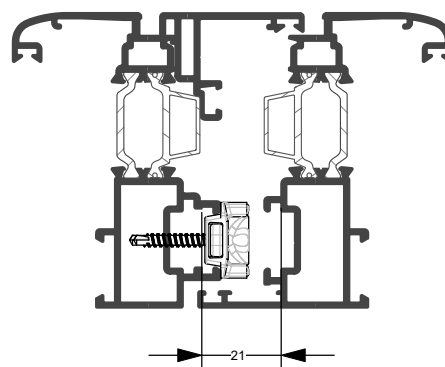

**ACX.03.71**

Catenaccio a leva "Mini tex"

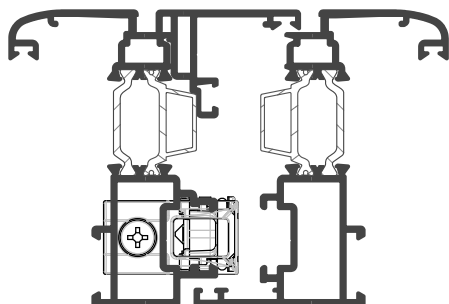
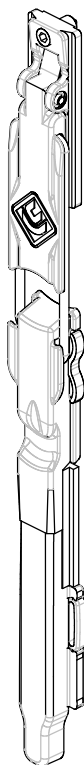





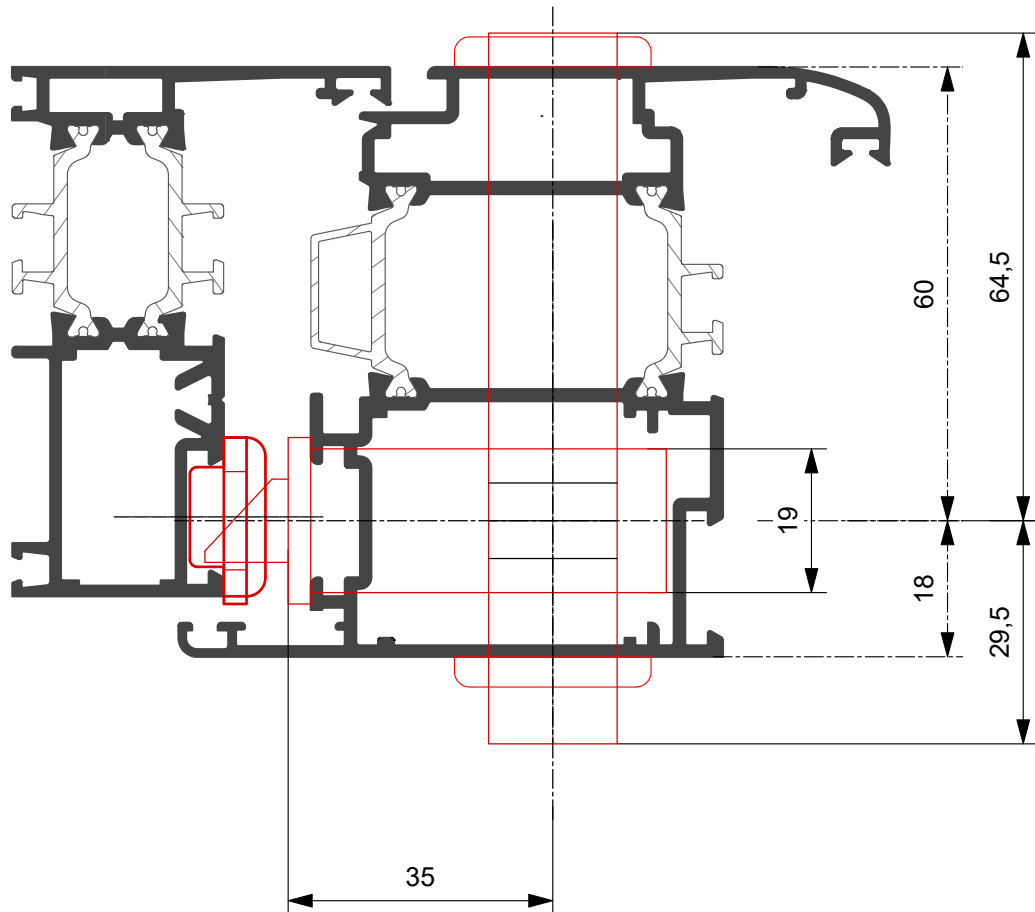

## SERRATURE DI SICUREZZA DA MONTANTE 1 PUNTO DI CHIUSURA

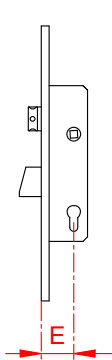
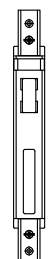

Riferimenti CISA

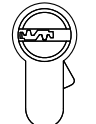
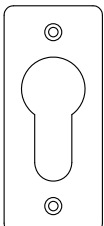



	Serratura E= 35 mm		Contropiastra		Cilindro		Borchia
	Tipologia	Art.	Metallo	Registrabile	Tradizionale	Sicurezza	
	Catenaccio e scrocco	46215		<b>06463 - 22- 0</b> per serrature rullo utilizzare inserto <b>06141.71.0</b>			 in dotazione
	Catenaccio e rullo	46230			<b>0E300. 41.0.12</b>	<b>0A3S1. 41.0.12</b>	
	Elettrica con maniglia	16215					

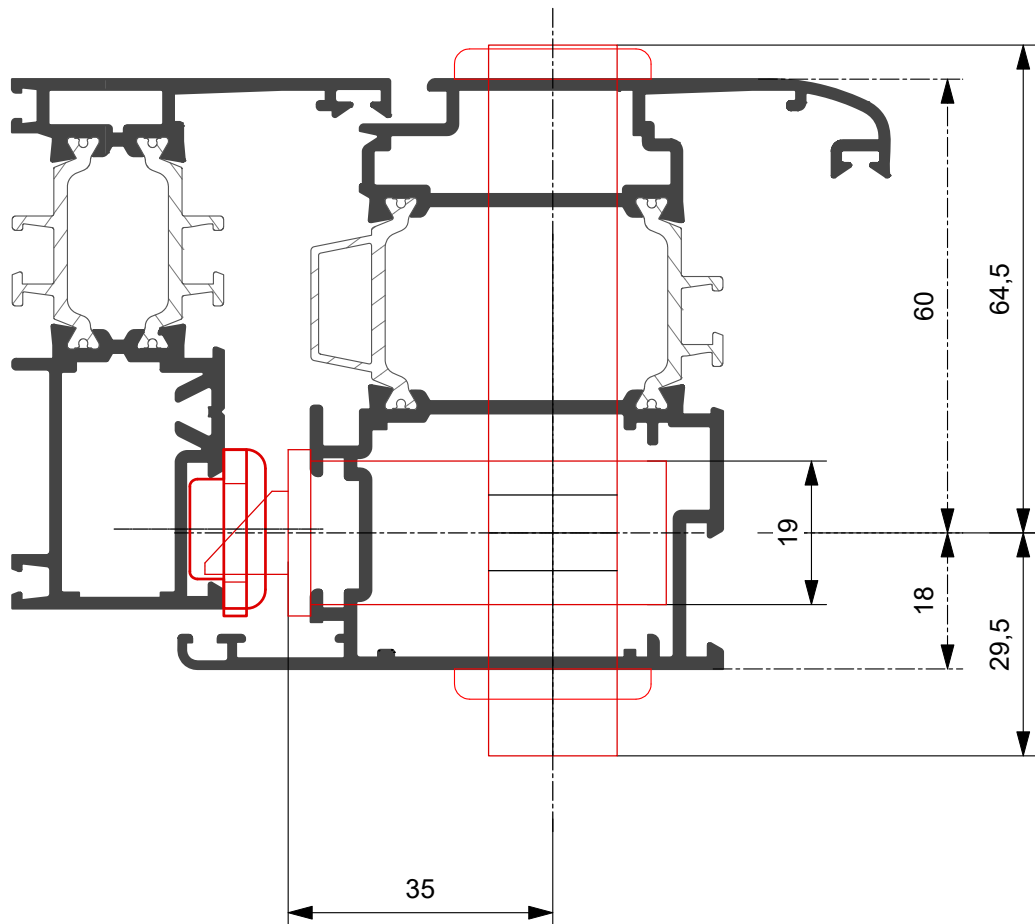

## SERRATURE DI SICUREZZA DA MONTANTE 3 PUNTI DI CHIUSURA

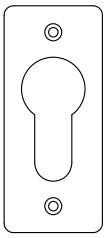
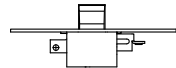

Riferimenti CISA





Serratura E= 35 mm	Contropiastra		Cilindro		Borchia		
	Tipologia	Art.	Metallo	Registrabile			
Catenaccio e scrocco	48225	 <b>06463- 32- 0</b> per serrature rullo utilizzare inserto <b>06141.71.0</b>	Serratura	Deviatori	 Tradizionale	 Sicurezza	 in dotazione
Catenaccio e rullo	48250			 06443-21/26-0			
Elettrica con maniglia	18225		 06465-42-0 (pz.2)		<b>0E300.</b> <b>41.0.12</b>	<b>0A3S1.</b> <b>41.0.12</b>	

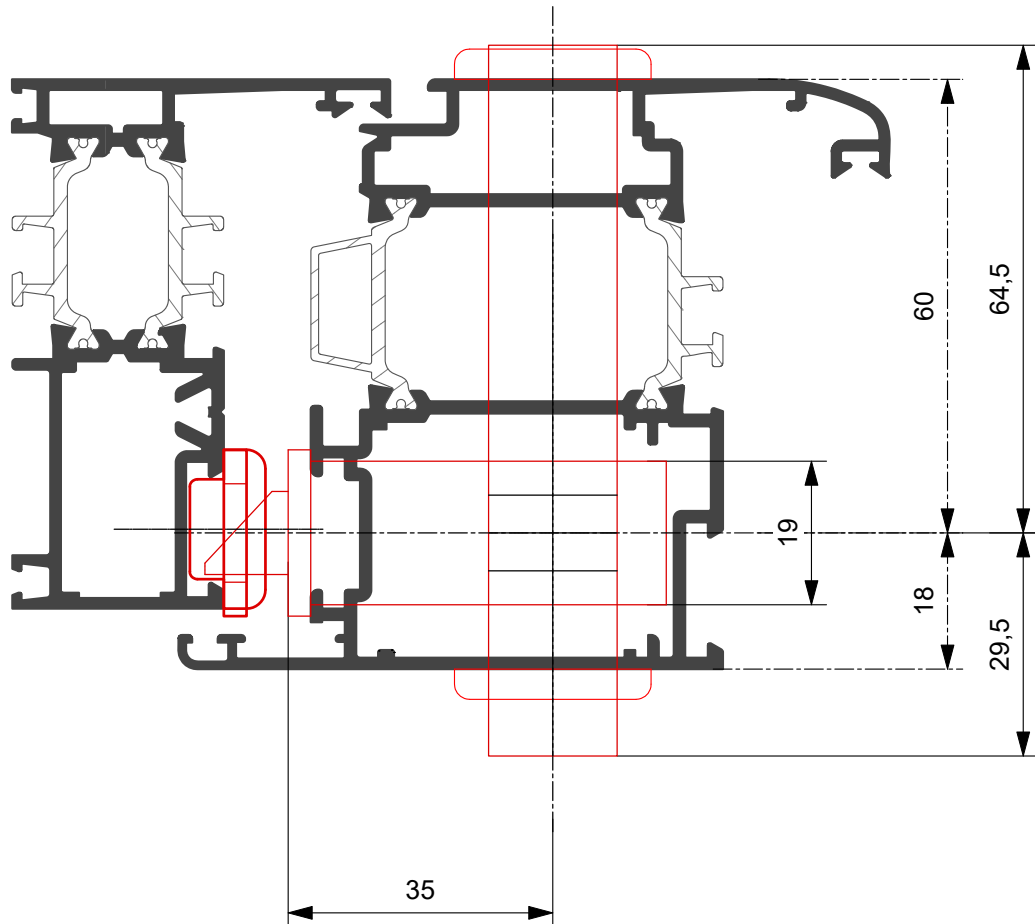

## SERRATURE DI SICUREZZA DA MONTANTE 3 PUNTI DI CHIUSURA - FRONTALE INTERO

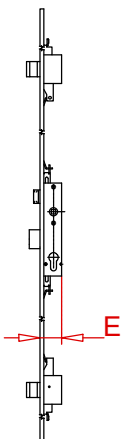

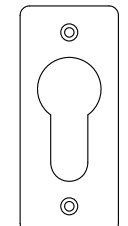
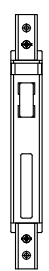
Riferimenti CISA

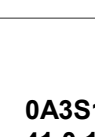

	Serratura E= 35 mm		Contropiastra		Cilindro		Borchia
	Tipologia	Art.	Metallo	Registrabile	 Tradizionale	 Sicurezza	 in dotazione
	Catenaccio e scrocco	48526	Serratura	Deviatori			
Catenaccio e rullo	48551	 <b>06463- 32- 0</b> per serrature rullo utilizzare inserto <b>06141.71.0</b>	 <b>06465-42-0</b> (pz.2)	 <b>0E300.</b> <b>41.0.12</b>	 <b>0A3S1.</b> <b>41.0.12</b>		
Elettrica con maniglia	18526						

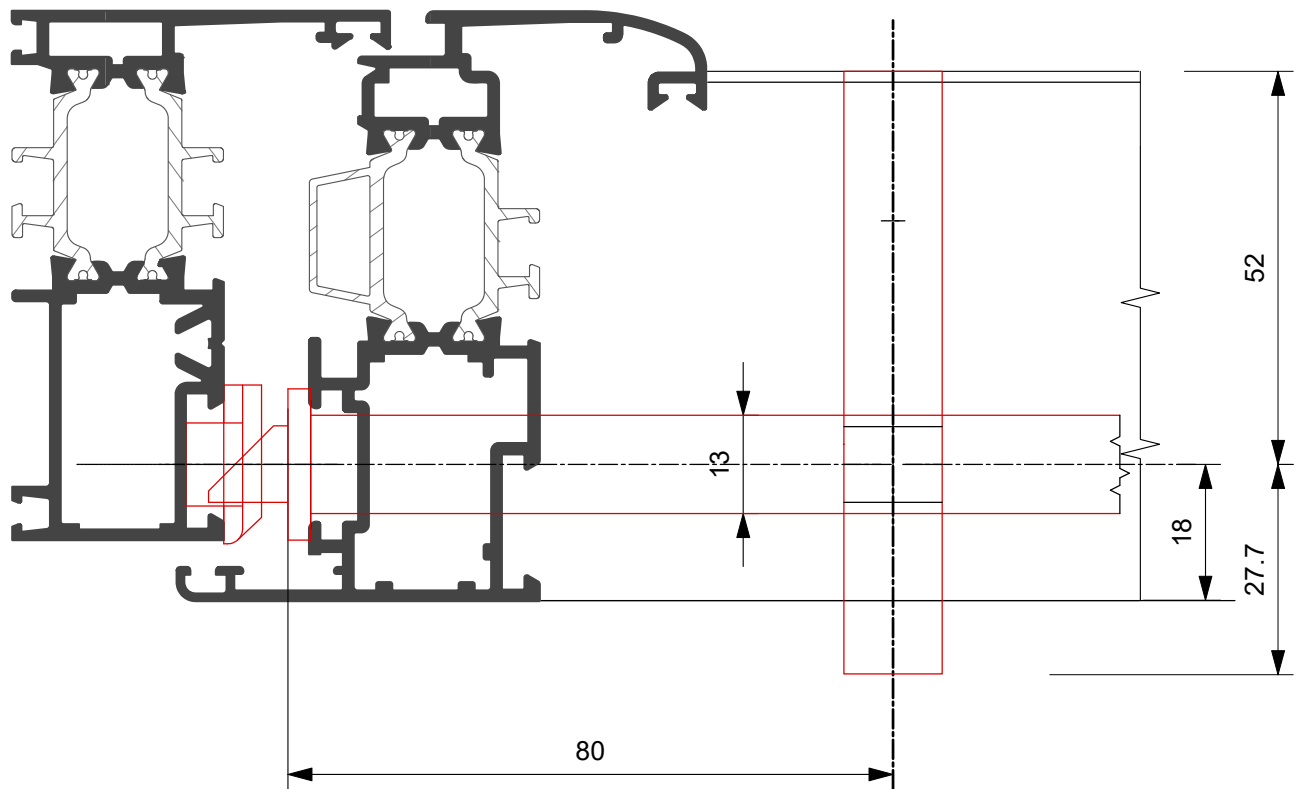

## SERRATURE A FASCIA 1 PUNTO DI CHIUSURA

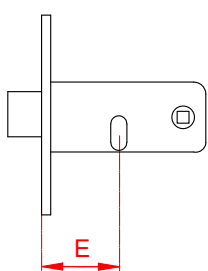

Riferimenti CISA

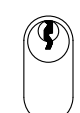
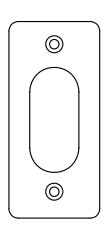



	Serratura E= 80 mm		Contropiastra		Cilindro	Borchia	
	Tipologia	Art	Nylon	Metallo Registrabile			
	Catenaccio e scrocco	44461 44151	06277-89-0		<b>06465 - 21 - 0</b> per serrature rullo utilizzare inserto <b>06141.71.0</b>	 Tradizionale	
	Catenaccio e rullo	44471	06277-90-0				
	Elettrica con maniglia	14451	06287-89-0				

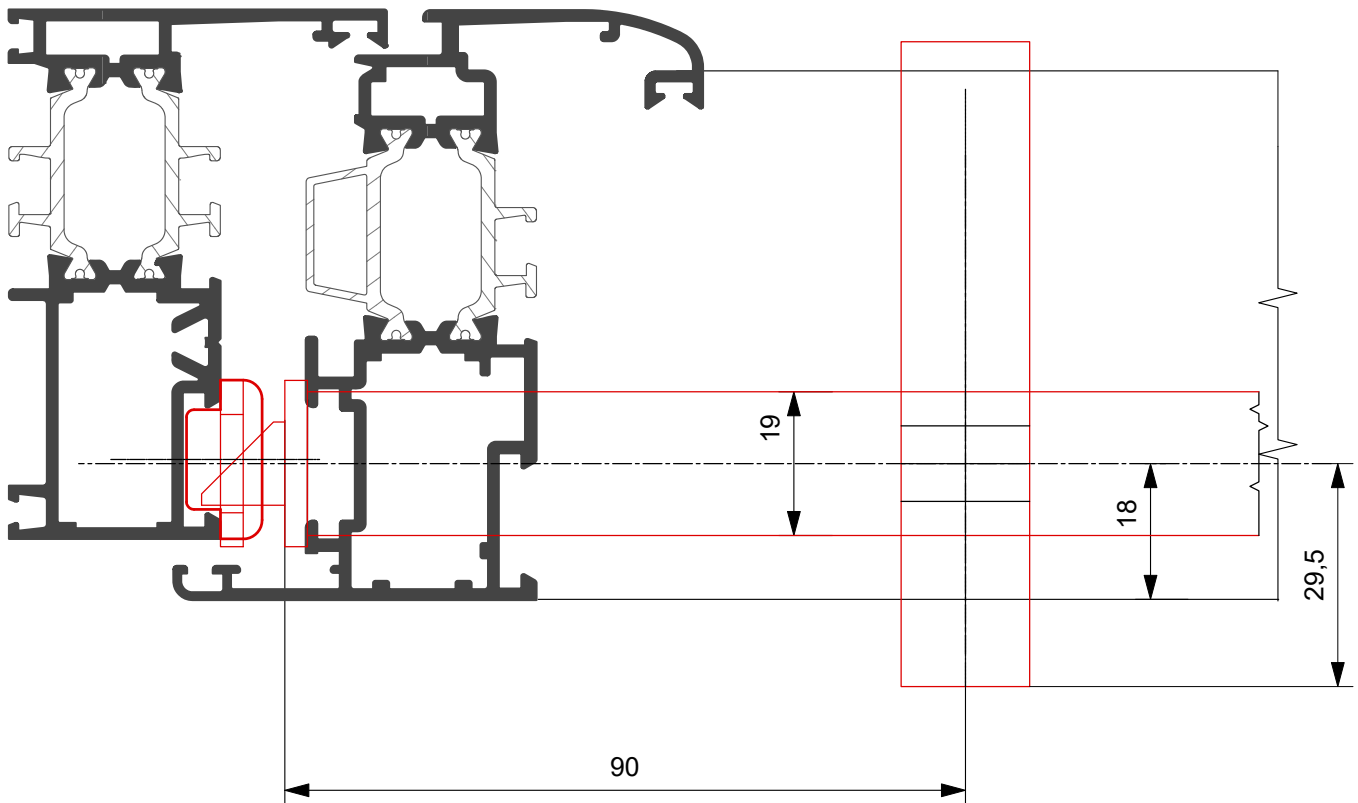

## SERRATURE DI SICUREZZA DA FASCIA A CILINDRO 3 PUNTI DI CHIUSURA

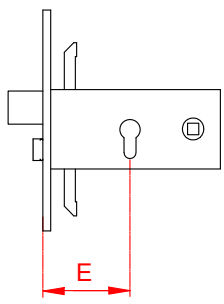

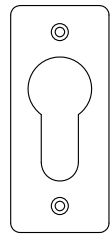
Riferimenti CISA



	Serratura doppia mappa E= 90 mm		Contropiastra		Cilindro		Borchia
	Tipologia	Art	Metallo	Registrabile			
Catenaccio e scrocco	<b>56357</b>			<b>06465 - 22- 0</b>	Tradizionale	Sicurezza	in dotazione
Kit rullo	<b>06168.00</b>			per serrature rullo utilizzare inserto <b>06141.71.0</b>	<b>0E300. 20.0.12</b>	<b>0A3S1. 20.0.12</b>	

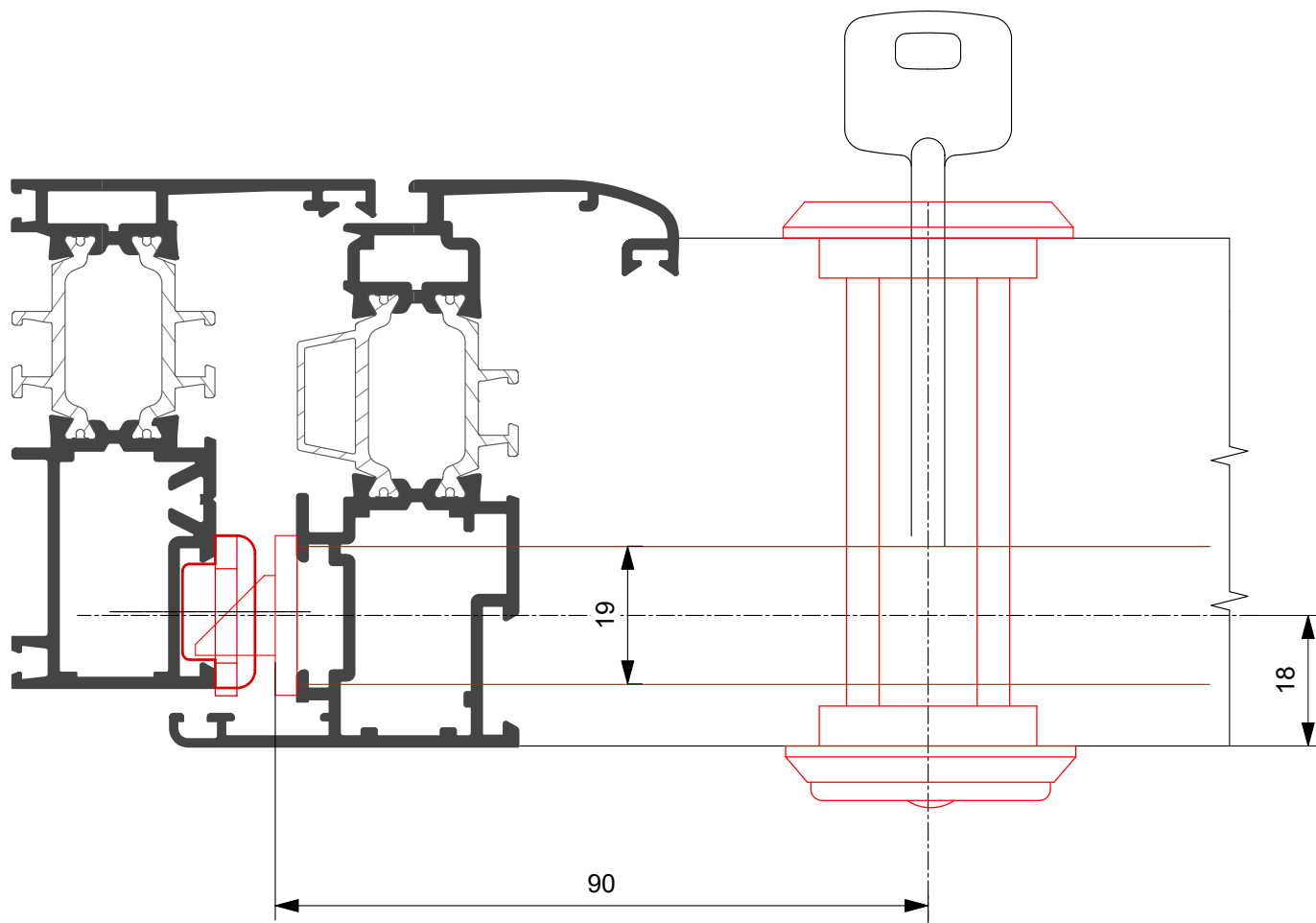

## SERRATURE DI SICUREZZA DA FASCIA A DOPPIA MAPPA 3 PUNTI DI CHIUSURA

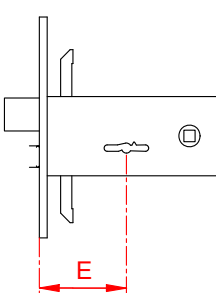

Riferimenti CISA

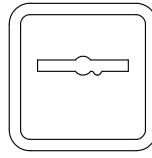



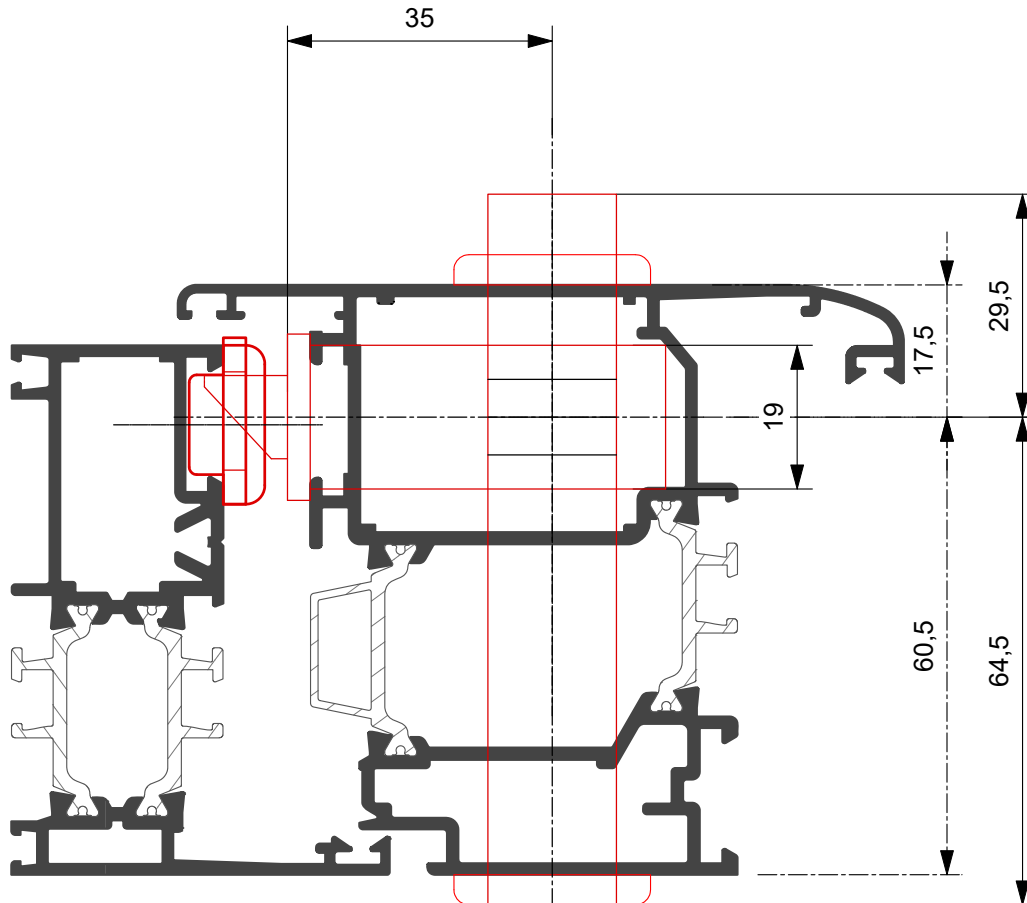

	Serratura Doppia Mappa E= 90 mm		Contropiastra	Borchia
	Tipologia	Art	Metallo Registrabile	
Catenaccio e scrocco	57357-91-0	 <b>06465 - 22- 0</b> per serrature rullo utilizzare inserto <b>06141.71.0</b>		
Catenaccio e rullo	57365-91-0			
Elettrica con maniglia	17357-91-0			
				<b>in dotazione</b>

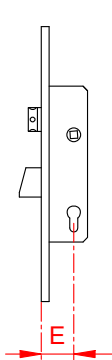

## SERRATURE DI SICUREZZA DA MONTANTE 1 PUNTI DI CHIUSURA

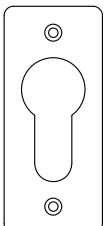

Riferimenti CISA

	Serratura E= 35 mm		Contropiastra		Cilindro		Borchia
	Tipologia	Art.	Metallo	Registrabile	 Tradizionale	 Sicurezza	 in dotazione
Catenaccio e scrocco	46215		Metallo	Registrabile	 Tradizionale	 Sicurezza	
Catenaccio e rullo	46230						<b>06463 - 22- 0</b> per serrature rullo utilizzare inserto <b>06141.71.0</b>
Elettrica con maniglia	16215						



## SERRATURE DI SICUREZZA DA MONTANTE 3 PUNTI DI CHIUSURA - FRONTALE INTERO

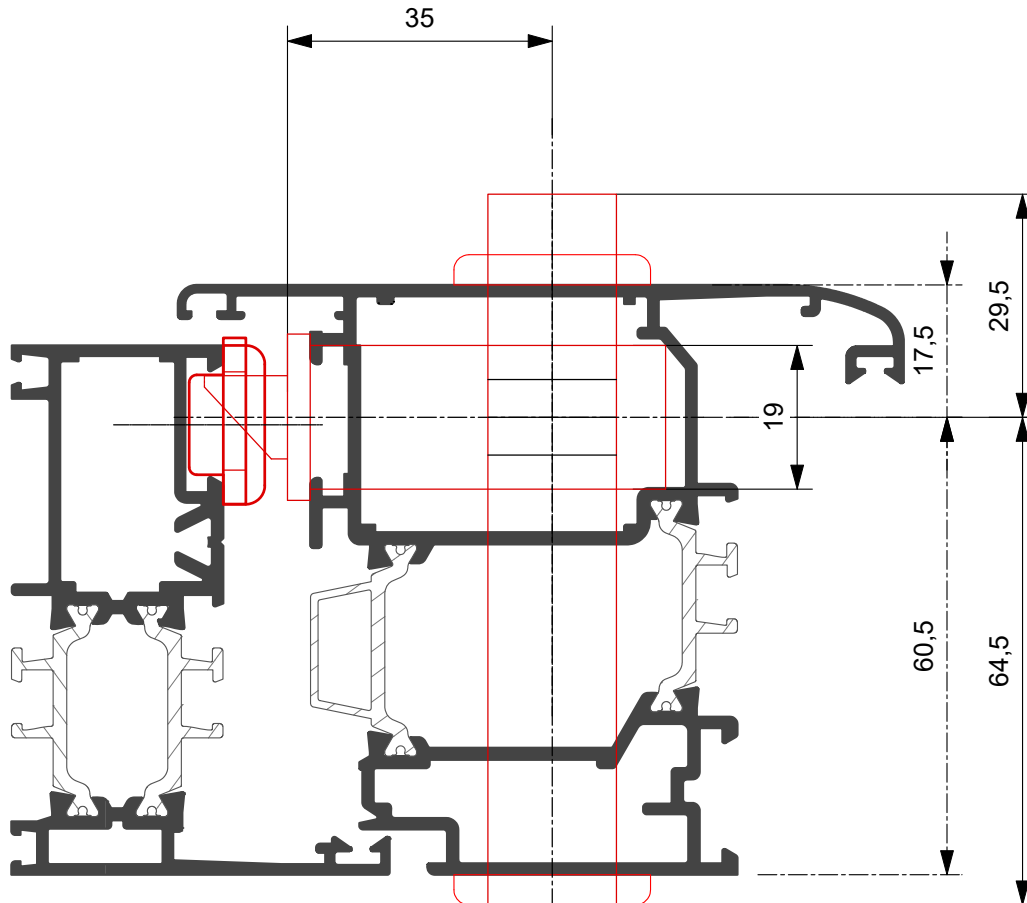

Riferimenti CISA

	Serratura E= 35 mm		Contropiastra		Cilindro		Borchia
	Tipologia	Art.	Metallo	Registrabile	 Tradizionale	 Sicurezza	 in dotazione
	Catenaccio e scrocco	48526	Serratura	Deviatori			
Catenaccio e rullo	48551	 <b>06463- 32- 0</b> per serrature rullo utilizzare inserto <b>06141.71.0</b>	 <b>06465-42-0</b> (pz.2)	<b>0E300.</b> <b>41.0.12</b>	<b>0A3S1.</b> <b>41.0.12</b>		
Elettrica con maniglia	18526						





## SERRATURE DI SICUREZZA DA MONTANTE 3 PUNTI DI CHIUSURA - FRONTALE INTERO

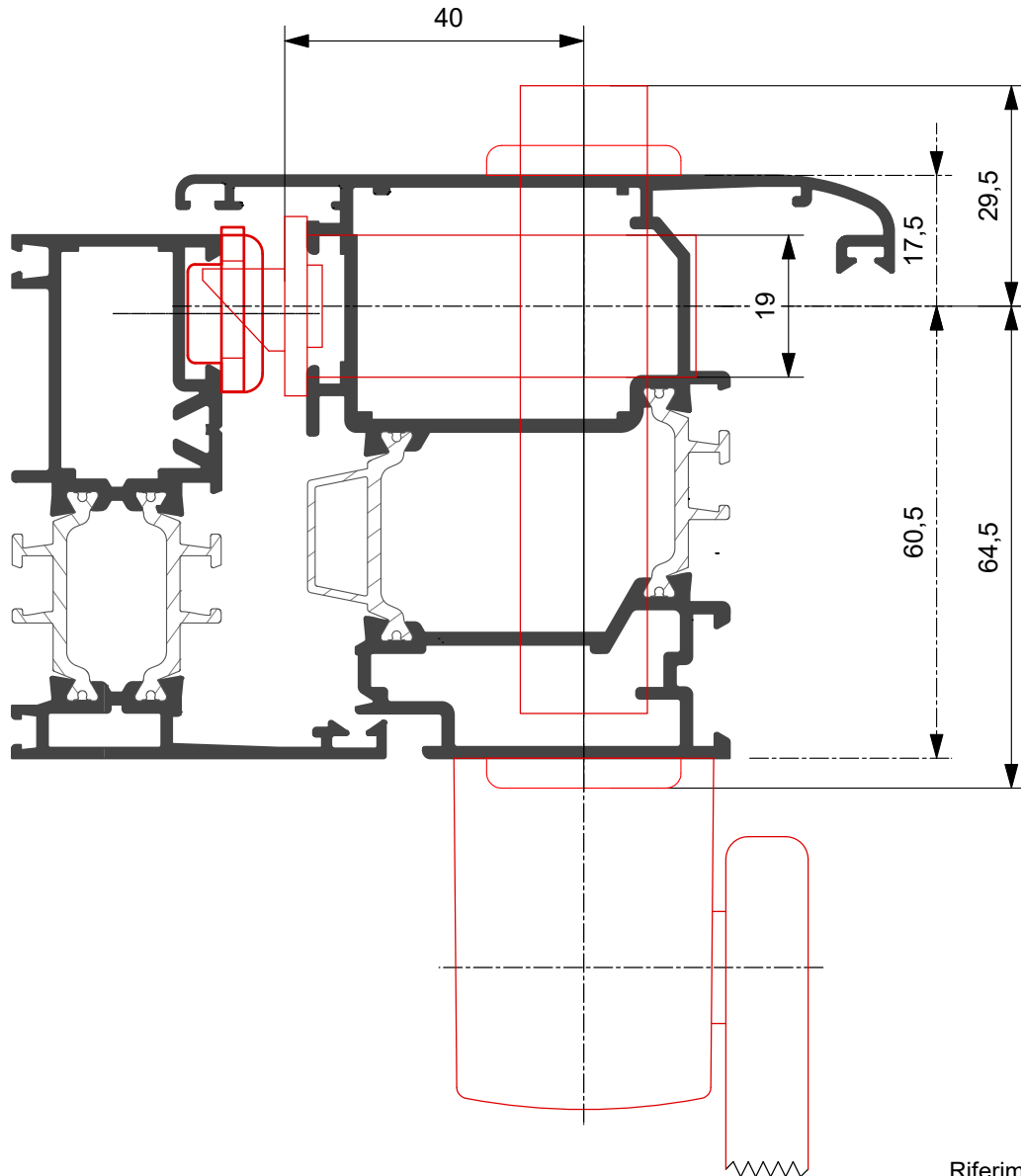

Riferimenti CISA

	Serratura E= 40 mm		Contropiastra		Cilindro		Borchia
	Tipologia	Art.	Metallo	Registrabile	Tradizionale	Sicurezza	in dotazione
			Serratura	Deviatori			
Catenaccio e scrocco Fun. A/D	43725	<b>06463- 32- 0</b> per serrature rullo utilizzare inserto <b>06141.71.0</b>		06465-22-0			
Catenaccio e scrocco Fun. B	43735				<b>0E300. 41.0.12</b>	<b>0A3S1. 41.0.12</b>	
Maniglione	59605.06						
Barra	07007.61						



### **PAM SYSTEM S.r.l.**

S.S. 230 - Fornace Crocicchio  
13030 Formigliana (VC)  
Tel. 0161 858811 - Fax 0161 858800  
www.pamsystemsrl.com - info@pamsystemsrl.com

### **ALQ System**

Via Colano, 9/A 12/K  
16162 Genova Bolzaneto  
Tel. +39 010 7491941 - Fax +39 010 7450155  
www.alqsystem.it - info@alqsystem.it

### **PAESANI GROUP**

#### **Paesani S.r.l.**

Via del Grano, 260  
47822 Santarcangelo di Romagna (Rn)  
Tel. +39 0541 748511 - Fax +39 0541 741208  
www.paesani.com - info@paesani.com

#### **Magazzino Nord**

Via Luigi Bonati, 21  
29017 Fiorenzuola d'Arda (PC)  
Tel. +39 0523 943228 - Fax +39 0523 941127  
magazzinonord@paesani.com

### **ALUK GROUP Centro di Firenze**

Pianidella Rugginosa, 203/206  
55066 Reggello (FI)  
Tel. 055 8662351/352 - Fax 055 8662065

### **DI.VA S.r.l.**

Via Po, 25 - Z. I. Sambuceto  
66020 San Giovanni Teatino (CH)  
Tel. 085 4405210 - Fax 085 4405207  
www.camel-diva.com - info@camel-diva.com

### **EUROALL S.r.l.**

Strada Comunale della Mola Saracena, 23  
00065 Fiano Romano (RM)  
Tel. 0765 455228/61 - Fax 0765 455317  
www.euroallsrl.it - info@euroallsrl.it

### **PROFILATI UMBRIA S.r.l.**

Via Dei Tigli, 35  
06083 Bastia Umbra (PG)  
Tel. 075 8012385-075 8010328 - Fax 075 8012386  
profilatiumbria@virgilio.it

### **TSL ALLUMINIO S.r.l.**

Via delle Industrie, 12 00030 San Cesareo (Roma)  
Tel. 06 2251591 (Ric. Aut.) - Fax 06 2280693  
www.tslluminio.it - info@tslluminio.it

### **ALLCAR SERVICE S.r.l.**

Via Acuto, 120 - 00131 Roma  
Tel. 06 4130626 (Ric. Aut.) - Fax 06 4130367  
allcarservice@mclink.it

### **ALLUCOM S.r.l.**

Via Vecchia Barletta 237  
Z. Ind. - 76123 Andria (BT)  
Tel. 0883 592213 - Fax 0883 552386  
www.allucom.com - info@allucom.com

### **ALLUCOM S.r.l.**

Via Zippitelli, 28/B - 70123 (BA)  
Tel. 0805058608 - Fax 0805058607  
www.allucom.com - info@allucom.com

### **CARUSO S.r.l.**

Z.I. Contrada Le Macere  
86019 Vinchiaturo (CB)  
Tel. 0874 340024 - Fax 0874 340025  
carusosrl1@libero.it

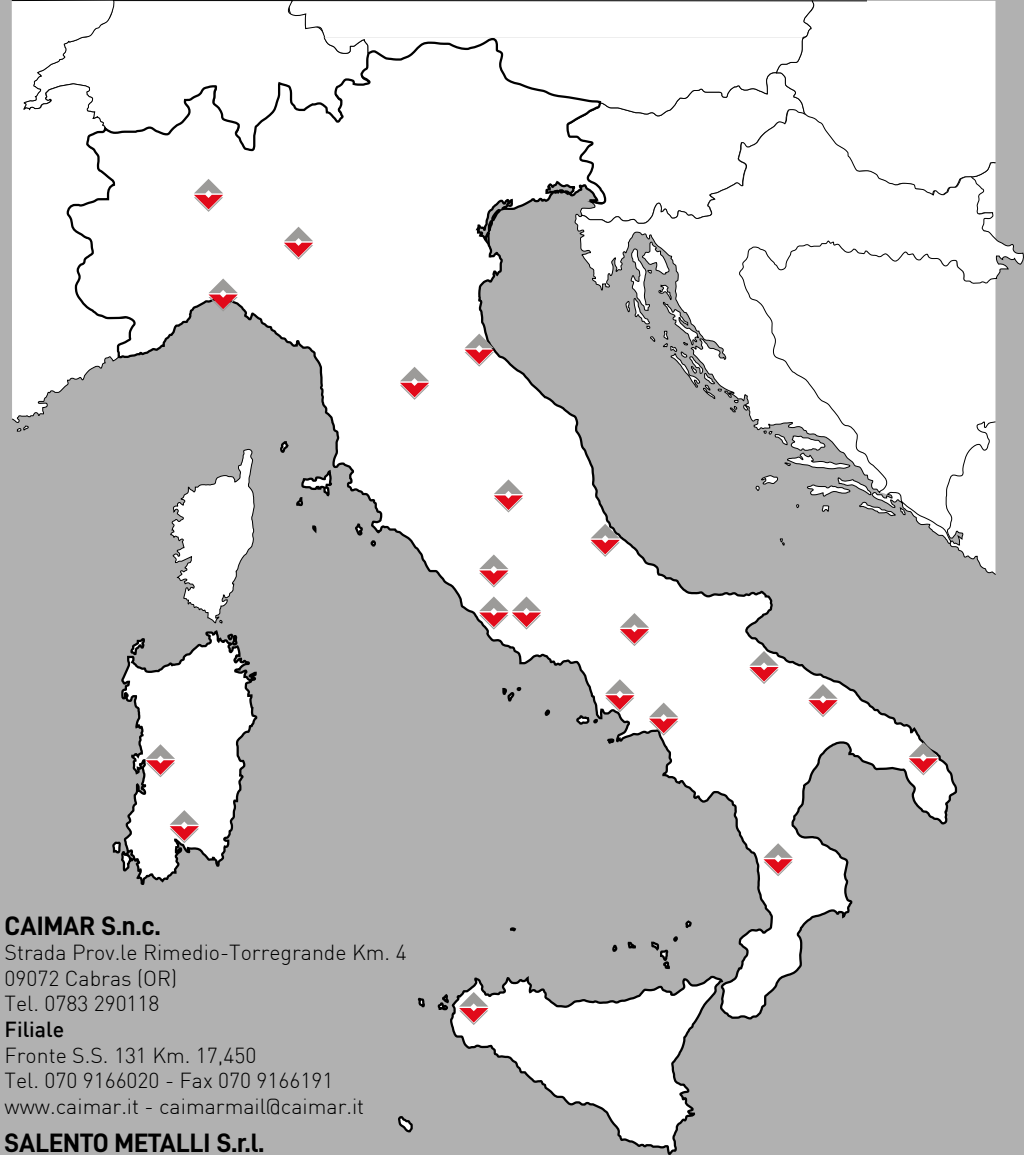

### **CAIMAR S.n.c.**

Strada Prov.le Rimedio-Torregrande Km. 4  
09072 Cabras (OR)  
Tel. 0783 290118

#### **Filiale**

Fronte S.S. 131 Km. 17,450  
Tel. 070 9166020 - Fax 070 9166191  
www.caimar.it - caimarmail@caimar.it

### **SALENTO METALLI S.r.l.**

Via Federico II, 13 - Zona PIP  
73020 Cavallino (LE)  
Tel. 0832 614576 - Fax 0832 614635  
www.salentometalli.it - info@salentometalli.it

### **MIDA ALLUMINIO S.r.l.**

Via Piano del Principe, 36  
80047 San Giuseppe Vesuviano (NA)  
Tel. 081 5297373 - Fax 081 8284449  
www.midaalluminigroup.it - info@gruppomida.it

### **MIDA ALLUMINIO S.r.l.**

Loc. Terzerie - Z. Ind.  
80061 Ogliastro Cilento (SA)  
Tel. 0974 833233 - Fax 0974 844724  
www.midaalluminigroup.it - info@midaalluminigroup.it

### **ITALBACOLOR S.r.l.**

C.da Valle S. Maria  
87024 Fuscaldo (CS)  
Tel. 0982 618025 - Fax 0982 720235  
www.italbacolor.it - commerciale@italbacolor.it

### **COMAS S.r.l.**

Via Porta Palermo, 84  
91011 Alcamo (TP)  
Tel. 0924 507050 - Fax 0924 507051  
www.comasgroup.it - info@comasgroup.it



[www.twinsystems.it](http://www.twinsystems.it) [info@twinsystems.it](mailto:info@twinsystems.it)

Consorzio **TWIN SYSTEMS**

Via delle Macere, 20 00060 Formello (Roma)  
Tel./Fax 06 23260298

